

808nm 20W VCSEL diode VD-0808I-020W-XX-2A0

FEATURES

- 808nm single wavelength
- Low wavelength drift
- Oxide isolation technology
- Low threshold current
- Small emission area
- Easy to collimate
- High reliability

APPLICATIONS

- Scanning lidars
- Pump source of solid-state laser
- Laser machining
- 3D sensors
- Cosmetics i.e. Hair removal

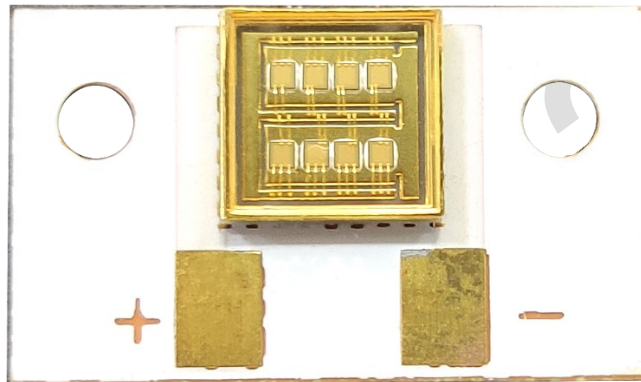

PRODUCT IDENTIFY

Part Number	Description
VD-0808I-020W-XX-2A0	808nm 20W VCSEL diode

Code Rules

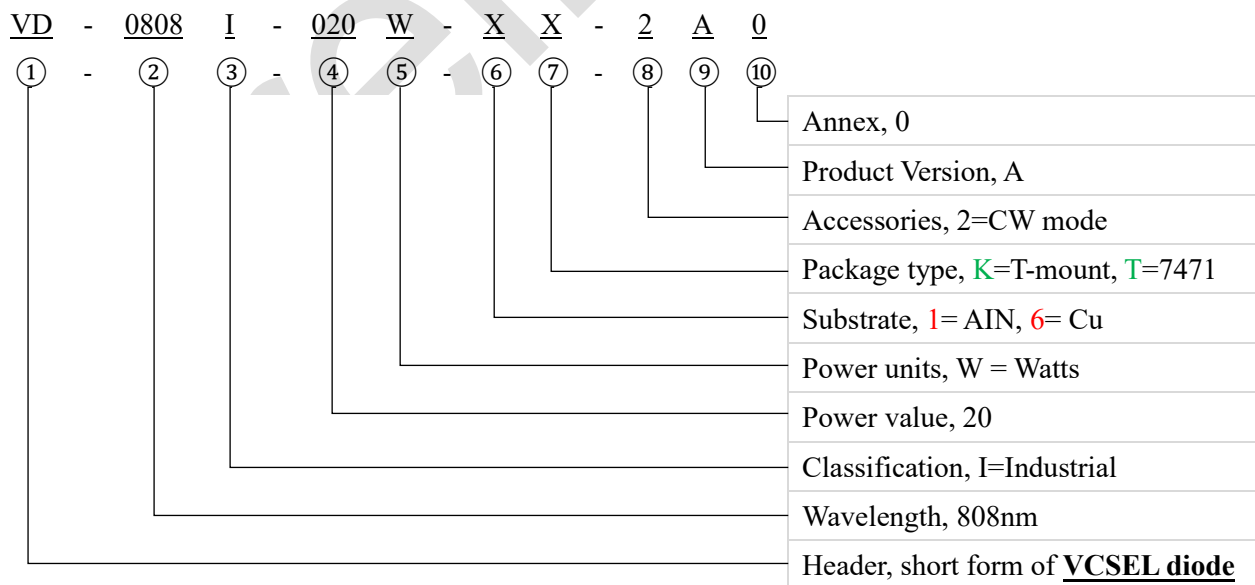

I. Absolute maximum ratings

Parameter	Symbol	Rating	Unit
Case Operating Temperature	T_{op}	-40 to +85	°C
Storage Temperature	T_{sto}	-40 to +105	°C
Reflow Soldering Temperature	T_{sdr}	260°C (10s)	-
Reverse Voltage	V_r	5	V
Maximum Continuous Current	I_{max}	30	A
ESD exposure (Human body) model	ESD	2k-4k (Class 2)	V
ESD exposure (Machine) Model	ESD	200-400 (Class B)	V

Note:

- Stresses greater than those listed under “Absolute Maximum Ratings” may cause permanent damage to the device. This is a stress rating only and functional operation of the device at these or other conditions above those indicated in the operations section for extended periods of time may affect reliability.
- In its maximum rating diode laser operation could damage its performance or cause potential safety hazard such as equipment failure.
- Electrostatic discharge is the main reason for the laser fault of the diode. Take effective precautions against ESD. When dealing with laser diodes, use the wrist strap, grounding work surface and strict antistatic technology.

II. Optical-electrical characteristics @25°C , CW mode

Parameters	Symbol	Condition	Min.	Typ.	Max.	Unit
Threshold Current	I_{th}		-	5	-	A
Forward Current	I_F		-	24	-	A
Optical Power	P_o	$I_F=24A$	-	20	-	W
Laser Forward Voltage	V_f	$I_F=24A$	-	2.64	-	V
Power conversion efficiency	η	$I_F=24A$	-	32	-	%
Slope efficiency	SE	$P_o=20W$	-	1.01	-	W/A
Series Resistance	R	$I_F=24A$	-	0.11	-	Ω
Peak Wavelength	-	$I_F=24A$	800	808	816	nm
Wavelength-Temp. Drift	$\Delta\lambda/\Delta T$	$I_F=24A$	-	0.07	-	nm/°C
Beam divergence	$(1/e^2)_B$		-	25	-	deg
Emission area			-	4.31x3.45	-	mm ²
No. of Emission Aperture			-	306x8	-	

Note: Electro-Optical Characteristic with a package or diffuser would require further evaluation. Values are based on limited sample size and estimated values.

III. Typical Performance

LIV curve & Wavelength

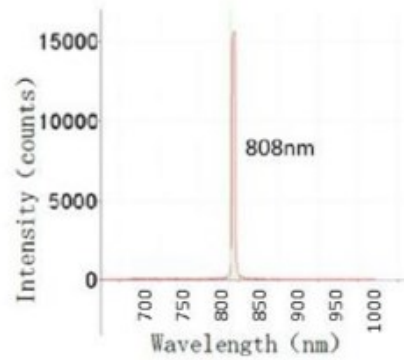
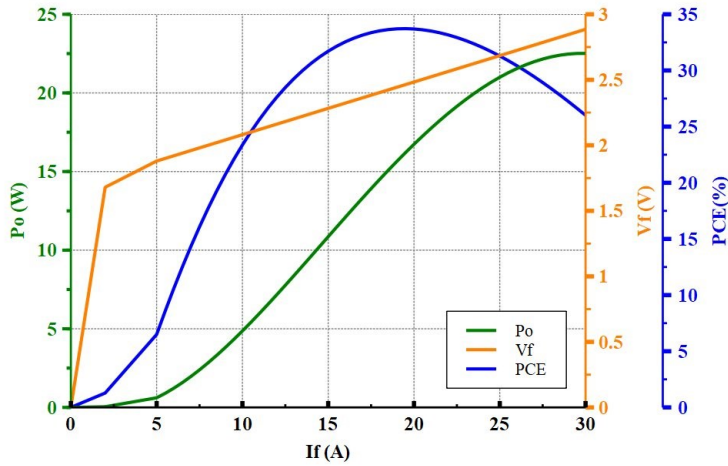

IV. Mechanical Schematics

VD-0808I-020W-1T-2A0 with Substrate 1=AIN and Package T=7471 (unit: mm)

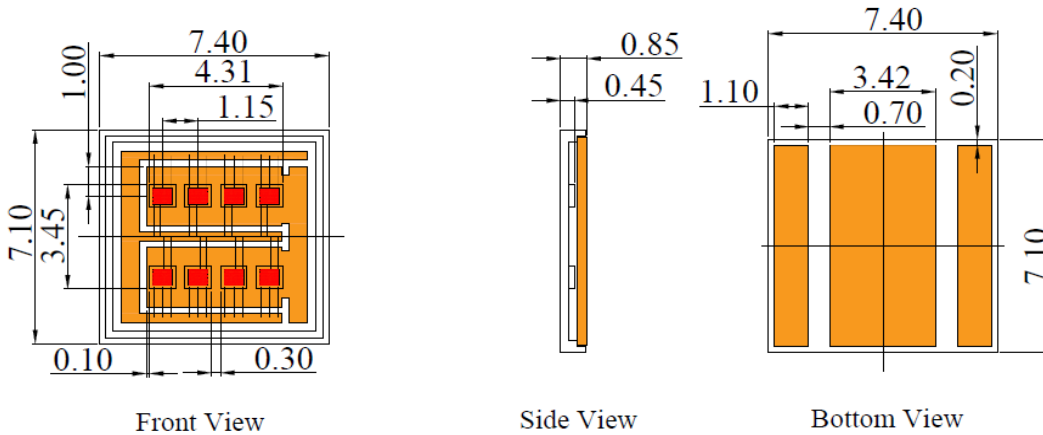

VD-0808I-020W-6K-2A0 with Substrate 4=P/Cu and Package K=T-mount (unit: mm)

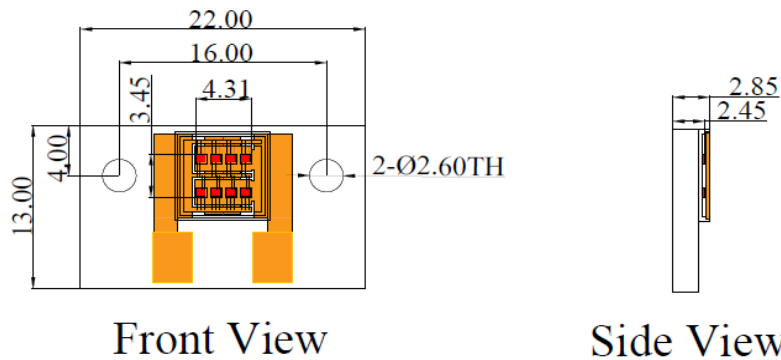

Note: There may be some changes between sample and drawing · thus · the actual spec please refer to the sample that you received. And if any inquires please contact us.

V. SMT Reflow Soldering Curve

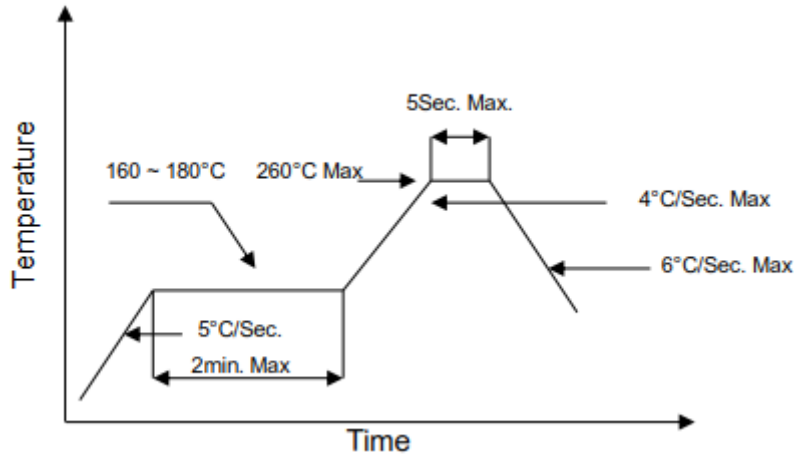

Note: Reflow soldering can be operated only one time. During the temperature ramp-up, no forces may be exerted on the diode which could deform or damage them. After soldering completed, please also do not process until the product temperature ramp down to room temperature.

VI. Treatment and protection measures

Soldering precautions

The temperature of soldering iron must be controlled under 300°C during manual soldering. Also, VCSEL can be only soldered one time with the soldering time less than 3s. but, it is very hard to control the soldering temperature and homogenize solder paste because of the smaller size of VCSEL. In addition, it is easy to damage VCSEL structure even causes VCSEL losing efficacy. So, we advise you to use re-flow soldering machine for operation.

Storage precautions

Our products were sealed by aluminum foil bag attaching packed desiccant, they are moisture proof and anti-static. Please handle these gently to avoid damage. At the same time, please be ready for storage and take some moisture-proof measures to keep the diode away from dampness that may causes reliability failure.

Before opening, the diode must be saved for at least 90 days below 30 °C with 60% RH.

After opening, the diode must be kept in an environment that temperature lower than 30 °C and humidity lower than 60% RH and used up within 24 hours. When the storage humidity reaches and exceeds 60%, the products must be dehumidified at 60 °C for more than 24 hours before use.

Others

1. Please use solder paste to cure the laser diode.
2. Please make sure that the heat of the diode has been completely conducted to metal shell, to avoid affecting the optical power output.
3. This diode can be only used in constant voltage and current.
4. Operating voltage and current, refer to the table in paragraph II.
5. Please do not aim the laser to people or animal.
6. You can observe the laser spot through an image monitoring equipment.

7. Please do not touch the diode surface by naked hands or squeeze the sealant on the diode surface, or it may cause wrong optical angle and distorted laser spot, even damage the diode.
8. Please use ceramic suction nozzle to absorb the diode, to avoid the diode sticking to the nozzle.
9. Please add a 0.02 s blowing action after locating the laser diode to aluminum substrate.

VII. Revision History

Revision	Date	Description
V.01	2020/10/12	The preliminary edition [VC5.0-306 2x4]

Note: Brightlaser reserves the right to make modification at any time due to improved design from time to time, the merit behind is to supply the best product possible.

Laser diode product components are intended for use in a user-devised end system. However, these products are capable of emitting laser radiation. Extreme care must be exercised during their operation. Only persons familiar with the appropriate safety precautions should operate a laser product. Directly viewing the laser beam or exposure to specular reflections must be avoided. Serious injury may result if any part of the body is exposed to the beam. The eye is extremely sensitive to the infrared radiation and therefore, proper eye wear must be worn at all times. Use of optical instruments with these products may increase eye hazard. Always wear eye protection when operating.



Preliminary