



Klaran WD Series UVC LEDs

- Emission in ideal germicidal range from 260 nm – 270 nm
- Compact, standardized 3535 package
- Appropriate for point-of-use disinfection

<i>Version</i>	<i>Date</i>
1.0	February 27, 2024

Product Bins¹

Klaran LEDs are binned by total output power (Pt) at 500 mA.

Part Number	Unit	Min
KL265-50W-SM-WD	mW	80
KL265-50V-SM-WD	mW	70
KL265-50U-SM-WD	mW	60
KL265-50T-SM-WD	mW	50

Notes

- Optical power output measurement tolerance of +/- 8%.

Specifications

LED Characteristics¹

Characteristic	Symbol	Unit	Min	Typical	Max
Peak Wavelength at 500 mA ²	λ_P	nm	260		270
Forward Voltage at 500 mA	V_F	V	5.0		8.0
Thermal Resistance	Rth	°C/W		7.0	
Power Dissipation at 500 mA ³	W	W			4.0
Viewing Angle ⁴	Θ	degrees		130	

Notes

- Test Condition: $T_A = 25\text{ °C}$
- Peak Wavelength Tolerance of +/- 1.8 nm
- Power Dissipation is calculated as $W = I_F \times V_F$
- Viewing angle is the angle over which the output intensity is at least half the peak output intensity (FWHM).

Absolute Maximum Ratings

Characteristic	Symbol	Unit	Min	Max
Forward Current (continuous)	I_F	mA	100	700
Reverse Voltage	V_r	V		-5
Operating Case Temperature Range at 500 mA	T_{opr}	°C	-10	80
Storage Temperature	T_{stg}	°C	-40	100
Junction Temperature ¹	T_j	°C		115

Notes

- Junction temperature is calculated as $T_j = T_s + R_{th} \times W$ where T_s is the temperature of the solder point.

Derating Characteristics

Output Over Temperature

Output power is very sensitive to junction temperature, which is affected by both ambient temperature and the use of proper thermal management techniques. Lower junction temperatures will ensure the optimal performance and lifetime of the LED. This plot shows the change in optical power with increase in ambient temperature while employing effective thermal management.

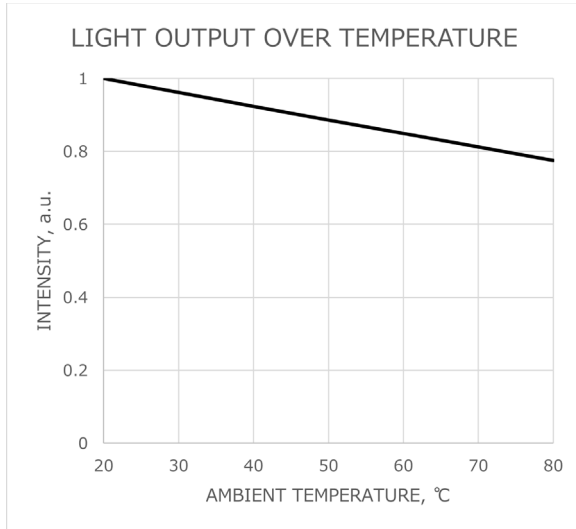

Test Conditions: Forward Current (I_F) pulse = 500 mA

Optical Characteristics

Spectrum

The plot shows the stability of the peak wavelength.

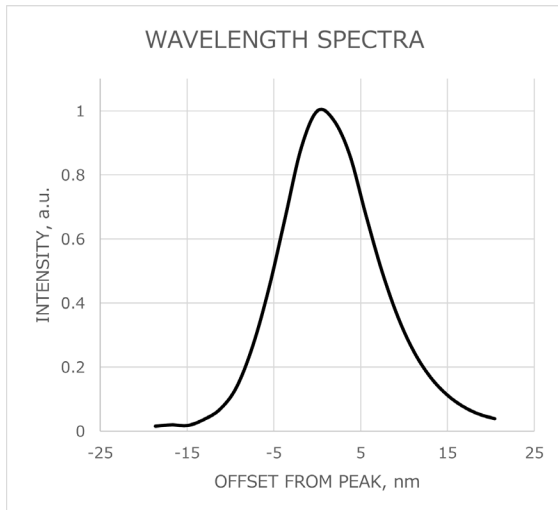

Test Conditions: I_F pulse = 500 mA; Case Temperature (T_C) = 20 °C

Radiation Pattern

Klaran WD LEDs have a nominal viewing angle of 130°.

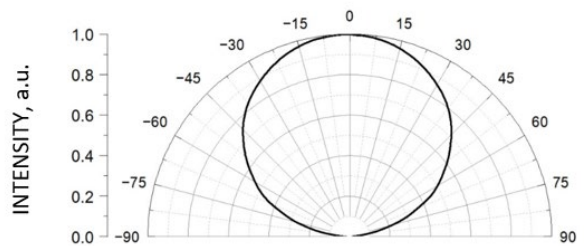

Test Conditions: I_F Continuous Wave Mode = 100 mA;
Ambient Temperature (T_A) = R.T.

Electrical & Temperature Characteristics

Electrical Characteristics

The maximum forward voltage is 8.0 V at an operating current of 500 mA.

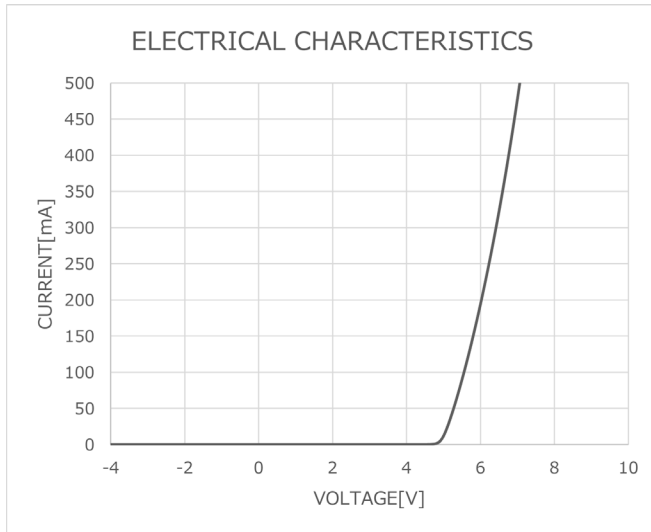

Test Conditions: Ambient Temperature (T_A) = R.T.
Electrical sweep from -5 V to 15 V

Voltage Shift over Temperature

Stability of voltage characteristics over temperature.

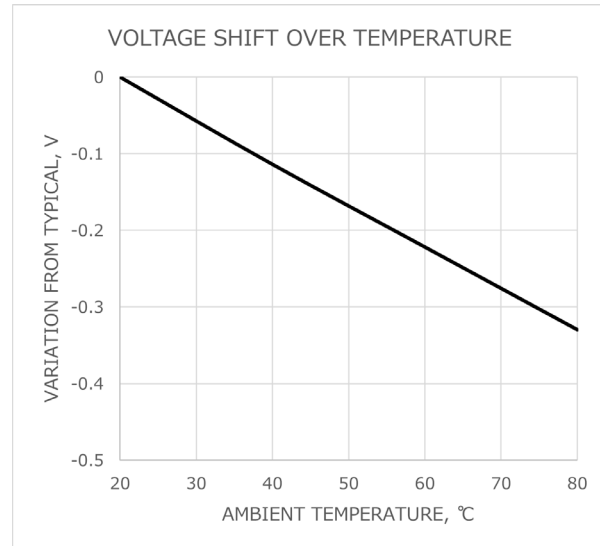

Test Conditions: I_F pulse = 500 mA

Light Output over Current

The plot shows the typical variation in light output with forward current.

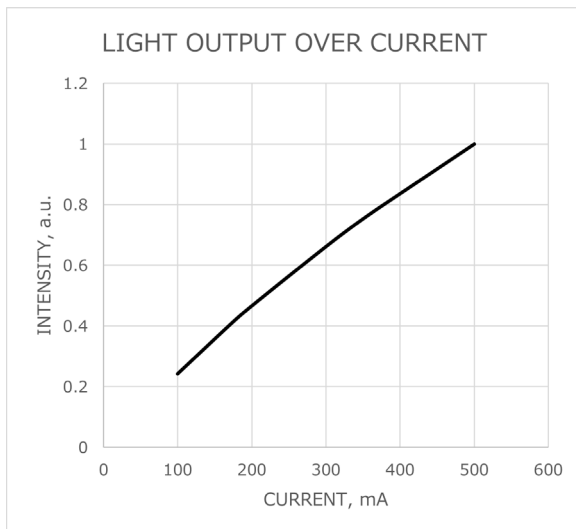

Test Conditions: I_F pulse; Case Temperature (T_C) = 20 °C

Wavelength Shift Over Current

Stability of wavelength characteristics over current

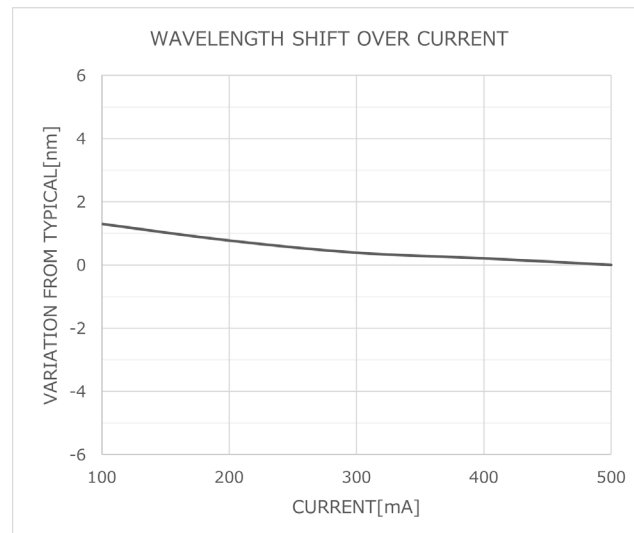

Test Conditions: I_F pulse; Case Temperature (T_C) = 20 °C

Wavelength Shift Over Temperature

Stability of wavelength characteristics over temperature

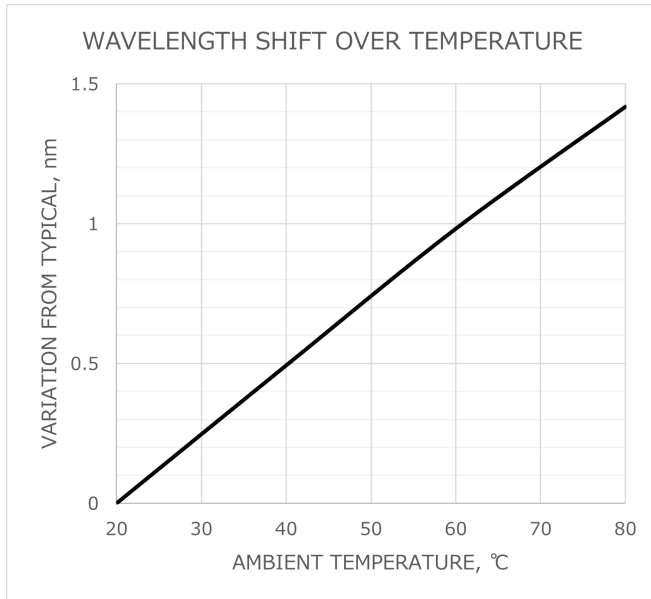

Test Conditions: I_f pulse = 500 mA

Mechanical Dimensions

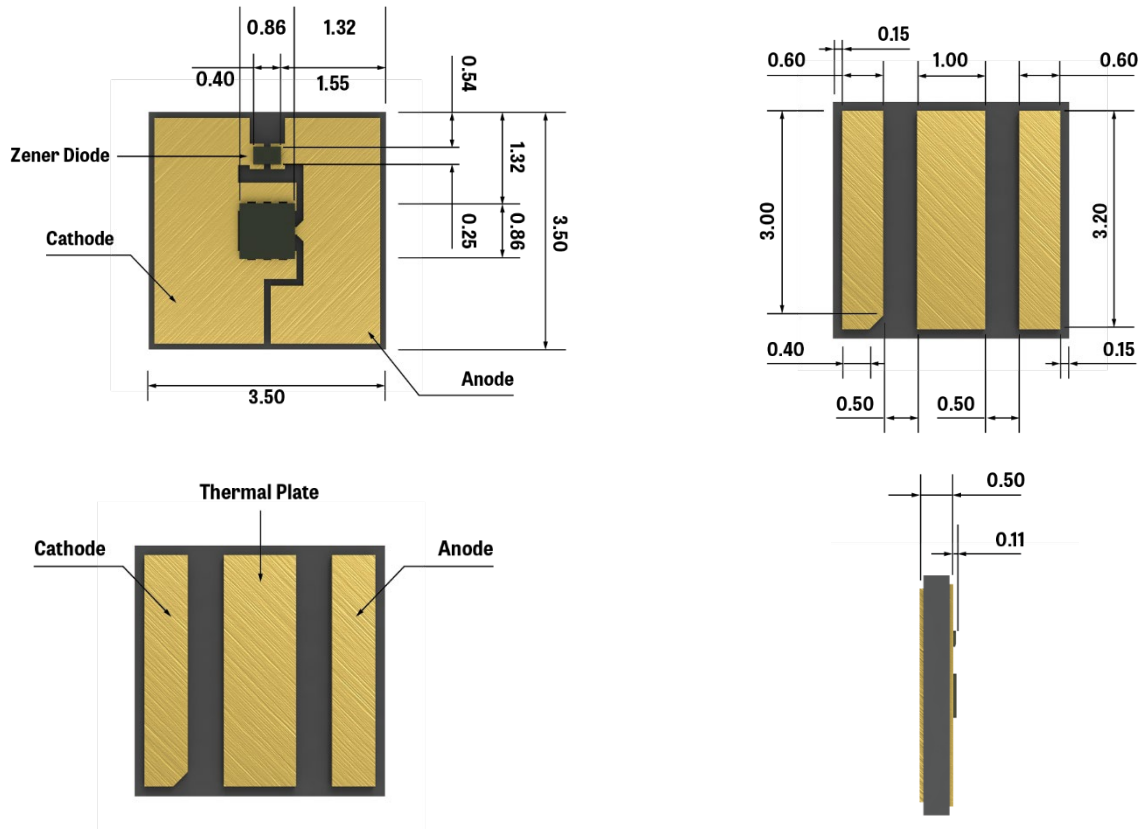

All dimensions are in millimeters. Unless otherwise noted, all dimensions have a tolerance of ± 0.05 mm. Dimensions are design values.

Solder Pattern

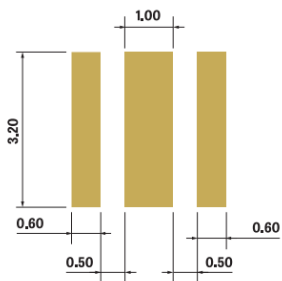

Recommended Soldering Guidelines

The recommended solder reflow profile for Klaran UVC LEDs follows the JEDEC standard J-STD-020D. **Hand soldering is not recommended for these devices.**

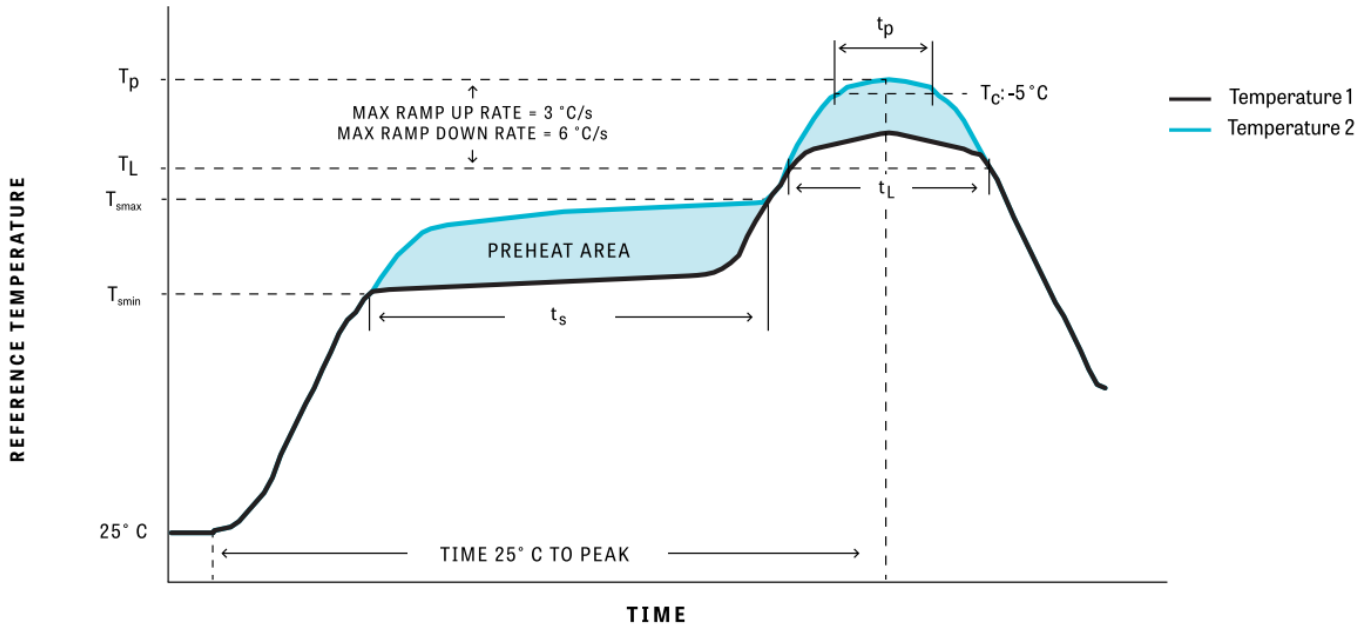

Guidelines

Profile Feature	Pb-Free Assembly
Preheat/Soak	
> Temperature Min (T_{smin})	150 °C
> Temperature Max (T_{smax})	200 °C
> Maximum Time (t_s) from T_{smin} to T_{smax}	60~120 seconds
Ramp-up rate (T_L to T_P)	3 °C / second max.
Liquidous Temperature (T_L)	217 °C
Time (t_L) maintained above T_L	60~150 seconds
Maximum peak package body temperature (T_P)	260 °C
Time (t_p) within 5 °C of the specified temperature (T_C)	Less than 30 seconds
Ramp-down rate (T_P to T_L)	6 °C/second max.
Maximum Time 25 °C to peak temperature	8 minutes max.

PCB & Assembly Considerations

- When populating boards in SMT production avoid excessive mechanical pressure on the product
- Pick and place nozzles must not impinge on the product die or zener diode
- Verify the PCB with the product before use – **metal PCB is recommended**
- PCB warpage after mounting products onto a PCB can cause the package to break
- LEDs should be placed in a way to minimize stress on the LED due to board flexing
- Do not rapidly cool device after soldering
- Do not apply mechanical force or excess vibration during the cooling process to normal temperature after soldering.

Circuit Design Considerations

- This LED product is designed for operation in forward current. Voltage should not be applied to the LED in the forward/reverse direction.
- The circuit should be designed so that the absolute maximum ratings are not exceeded for each LED.
- **The LED should be operated in constant current mode for each LED.**
 - If parallel connection is used, it is necessary to adjust the current by inserting a resistor or driver
- Special precautions must be taken when using LED drivers as they can typically output much higher voltages than are needed for UVC LEDs:
 - Ensure the driver is properly hooked up – if reversed there is often enough voltage to damage the device operated in reverse bias.
 - The driver should be attached to the LED before applying power, otherwise the driver will be outputting the maximum voltage and will often result in a current surge when making contact.
 - The current waveform should be verified to be sure there are no current spikes with turning the device on

Below are some typical circuit designs for using multiple LEDs

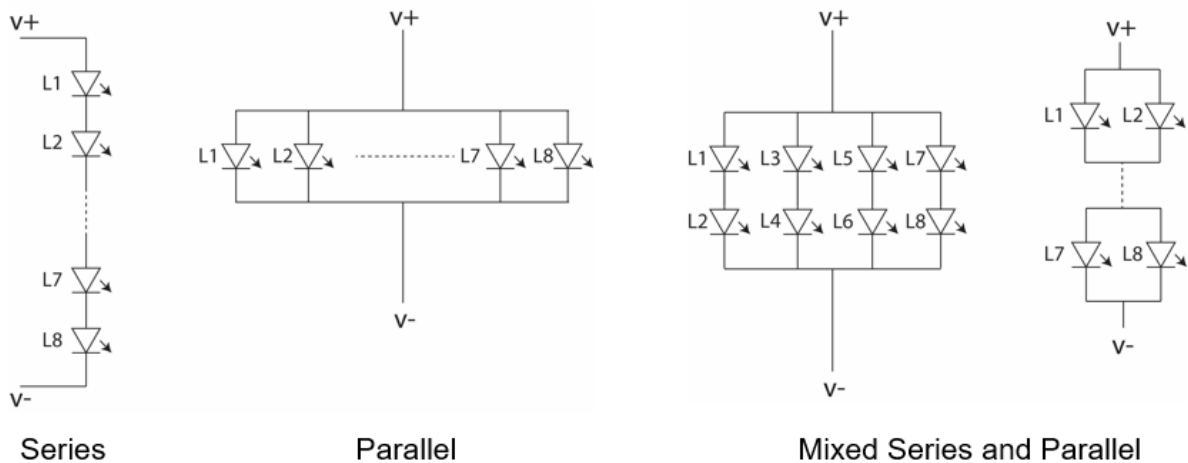

Reliability Testing & Criteria

Tests and Results

Test	Test Conditions	Test Duration	Failed / Tested
Temperature Cycling	-65°C (30m) ~ 150°C (30m)	100 cycles	0 / 20
High Temperature Storage	T _a = 150°C	1000 hours	0 / 20
High Humidity, High Temperature Storage	T _a = 85°C, 85%RH,	1000 hours	0 / 20
Low Temperature Storage*	T _a = -40°C	1000 hours	0 / 30
Room Temperature Operation	T _a = 25°C, I _f = 500 mA	1000 hours	0 / 20
High Temperature Operation	T _a = 55°C, I _f = 350 mA	500 hours	0 / 20
High Humidity, High Temperature Operation	T _a = 55°C, 85%RH, I _f = 250 mA	500 hours	0 / 20
Low Temperature Operation*	T _a = -10°C, I _f = 500 mA	500 hours	0 / 30
Vibration*	200 m/s ² , 100~2000~100 Hz, 4 cycles, 4 m, each x,y,z	48 minutes	0 / 30
Shock*	Half Sine Shock @500G	5 shocks @ X, Y, Z	0 / 30
ESD Protection Level	HBM 2kV	3 times	0 / 3 (Forward) 0 / 3 (Reverse)

*Testing results from representative Klaran UVC LEDs

Failure Criteria

Parameter	Symbol	Test Conditions	Failure Criteria
Output Power	P _t	I _f pulse = 500 mA	< Initial Value x 0.5
Forward Voltage	V _f	I _f pulse = 500 mA	< Initial Value x 0.8 > Initial value x 1.2

Notes: These tests do not indicate actual product lifetime. Contact our team for additional details on overall lifetime performance.

Important Usage Notes

ESD Sensitivity

- **CAUTION: LEDs are ESD (electrostatic discharge) sensitive**
 - **Product has been tested to HBM 2kV**
- Static electricity and surge voltages seriously damage UV LEDs and can result in product failure
- Ensure that tools, jigs and machines being used are properly grounded
- LED mounting equipment should include protection against voltage surge
- Use proper ESD protection, including grounded wrist straps, ESD footwear and clothes

Thermal Management

- Excess heat will negatively impact the performance and lifetime of the LED
- A metal-core or metal base PCB is recommended.
- When assembling arrays of LEDs, ensure that your calculations properly account for the size of heatsink required for proper thermal dissipation

Storage Conditions

- **Product complies with JEDEC MSL1 or equivalent** and is shipped in a moisture proof package (with silica desiccant). See IPC/JEDEC STD-202 for moisture sensitivity details.
 - *MSL1 was confirmed from representative Klaran UVC LEDs*
- Product should be stored in a controlled dust-free environment
- To avoid condensation, LEDs should be stored in an environment with minimal fluctuations in temperature and humidity

Handling

- The UVC LED is not protected by a lens and requires careful handling
- Do not handle the LED with bare hands as it may contaminate the LED surface and affect the optical characteristics
- Avoid touching the LED die or LED surface as it could cause a catastrophic failure (ie the LED will not turn on)
- Do not use adhesives that outgas organic vapor
- Dropping the product may cause damage
- If handling the product with tweezers, use only the side of the package and be careful not to apply excessive force

Cleaning

- The UVC LED is not protected by a lens and requires careful cleaning
- Isopropanol Alcohol rinse can be used, no mechanical or ultrasonic bath.

Safety

- During operation, the LED emits high intensity ultraviolet (UV) light, which is harmful to skin and eyes.
- UV light is hazardous to skin and may cause cancer.
- Avoid exposure to UV light when LED is operational.
- Precautions must be taken to avoid looking directly at the UV light without the use of UV light protective glasses.
- Do not look directly at the front of the LED or at the LED's lens when LED is operational.
- Attach warning labels on products/systems that use UV LEDs.

Certifications

ROHS COMPLIANCE

The levels of environmentally sensitive, persistent biologically toxic (PBT), persistent organic pollutants (POP), or otherwise restricted materials in this product are below the maximum concentration values (also referred to as the threshold limits) permitted for such substances, or are used in an exempted application, in accordance with EU Directive 2015/863 on the restriction of the use of certain hazardous substances in electrical and electronic equipment (RoHS).

REACH

This product and associated materials, packing materials and associated production processes are in compliance with Regulation (EC) No 1907/2006 - Registration, Evaluation, Authorisation and Restriction of Chemicals (REACH) and its latest revised version, Commission Regulation (EU) 2022/586.

To access the compliance declarations associated with this product, please visit <https://www.cisuvc.com/company/quality-documents/>

Packaging Details

BULK PACKAGING INFORMATION

Please contact Crystal IS for package, case and pallet information and labeling.

TAPE AND REEL INFORMATION

Klaran LED products are packaged in tape and reel quantities of 1000 for machine manufacturing. Devices are placed with the cathode to the left so the polarity direction is cathode to anode.

Tape Dimensions

Top View

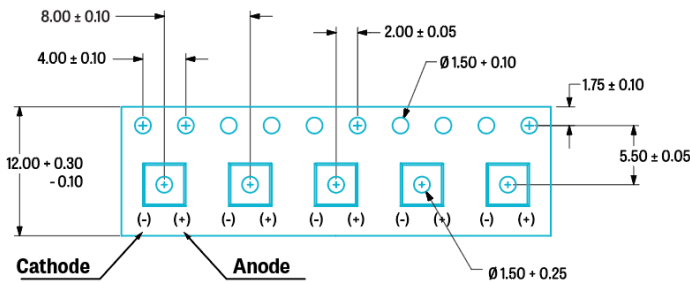

Side View

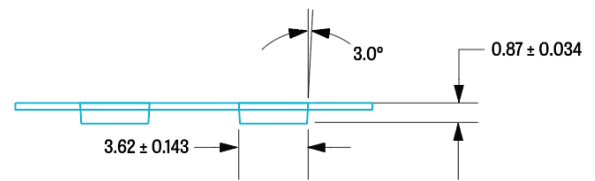

All dimensions are in millimeters (mm)
All dimensions are design values and have not been 100% inspected.

Reel Information

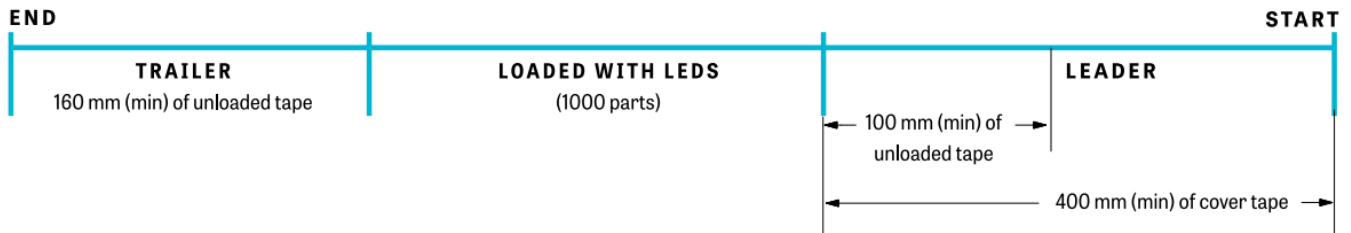

Each reel includes a leader and trailer section that is not loaded with LEDs.

NOMENCLATURE INFORMATION

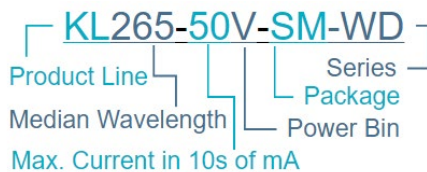

Disclaimer

The specifications, characteristics, and technical data presented in this datasheet are subject to change without prior notice. It is recommended that the most updated specifications, characteristics, and technical data be used in your application.

The information in this document has been compiled from reference materials and other sources believed to be reliable and given in good faith. No warranty, either expressed or implied, is made, however, to the accuracy and completeness of the information, nor is any responsibility assumed or implied for any loss or damage resulting from inaccuracies or omissions. Each user bears full responsibility for making their own determination as to the suitability of Crystal IS products, recommendations or advice for its own particular use. Crystal IS makes no warranty or guarantee, express or implied, as to results obtained in end-use, nor of any design incorporating its Products, recommendation or advice.

Each user must identify and perform all tests and analyses necessary to ensure that it's finished application incorporating Crystal IS' products will be safe and suitable for use under end-use conditions. Each user of devices assumes full responsibility to become educated in and to protect from harmful irradiation. Crystal IS specifically disclaims any and all liability for harm arising from buyer's use or misuse of UVC devices either in development or end-use

Crystal IS, an Asahi Kasei Company

70 Cohoes Avenue, Green Island, NY 12183 USA

518.271.7375 | www.cisuvc.com | sales@cisuvc.com

© Crystal IS, Inc. All Rights Reserved. Crystal IS, Klaran and the Crystal IS logo are trademarks of Crystal IS, Inc. And/or its affiliates. All other trademarks are property of their respective owners.