

## 2J3715M-868

868 MHz ISM Magnetic Mount

### Key Features

- 868 MHz ISM
- 863-870 MHz
- Magnetic Mount
- Low Profile
- Ground Plane Dependent
- Customizable Cable and Connector
- Dimensions Ø 31 x 71.5 mm



## 1. Antenna and electrical specifications

Parameters	868 MHz ISM Antenna
<b>Standards</b>	ZigBee, ISM, SIGFOX, LoRa
<b>Band (MHz)</b>	868 MHz
<b>Frequency (MHz)</b>	863-870
<b>Return Loss (dB)</b>	~-16.4
<b>VSWR</b>	~1.4:1
<b>Efficiency (%)</b>	~58.9
<b>Peak Gain (dBi)</b>	~1.7
<b>Average Gain (dB)</b>	~-2.3
<b>Impedance (Ohm)</b>	50
<b>Polarisation</b>	Linear
<b>Radiation Pattern</b>	Omni-Directional
<b>Max. Input Power (W)</b>	25
<b>Connector Type</b>	SMA-Male Standard (Other Connectors Available)
<b>Cable Length</b>	300 cm Standard (Any Cable Length Available)
<b>Cable Type</b>	RG174 Standard (Other Cables Available)

### Antenna Measurement Conditions:

Mounted on 30 x 30 cm Ground Plane

200 cm RG174 Cable Length

Measured in Certified CTIA 3D Anechoic Chamber

## 2. Mechanical and environmental specifications

Specifications	2J3715M-868
<b>Mounting Type</b>	Magnetic Mount
<b>Dimensions (mm)</b>	Ø 31 × 71.5
<b>Radome</b>	PC/ABS UV Stable
<b>Radome color</b>	Black
<b>Operating Temperature (C)</b>	-40 to +85
<b>Storage Temperature (C)</b>	-40 to +85
<b>Substance Compliance</b>	RoHS

### 3. Antenna parameters

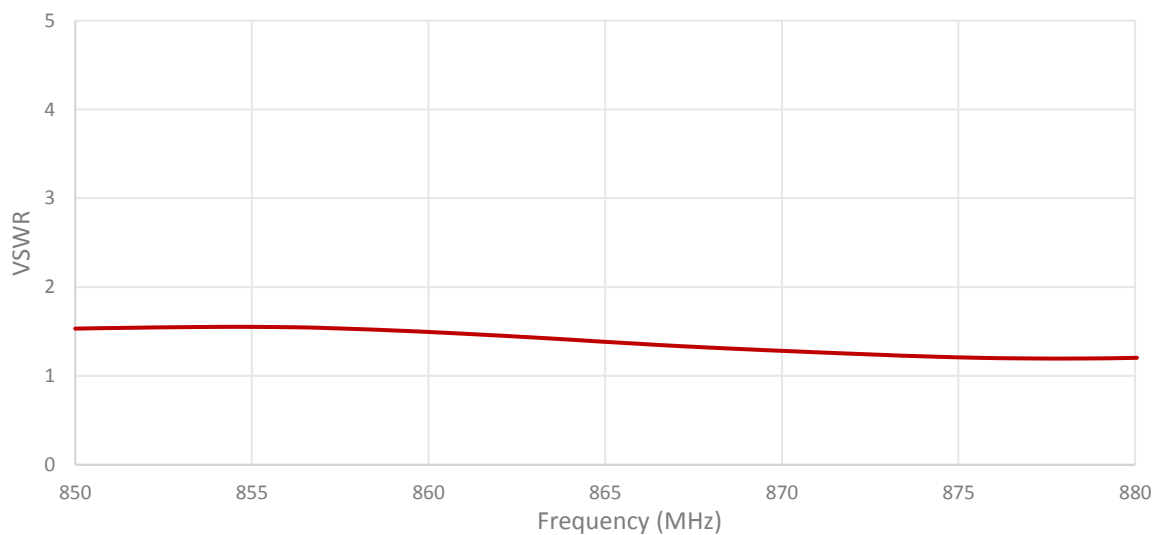
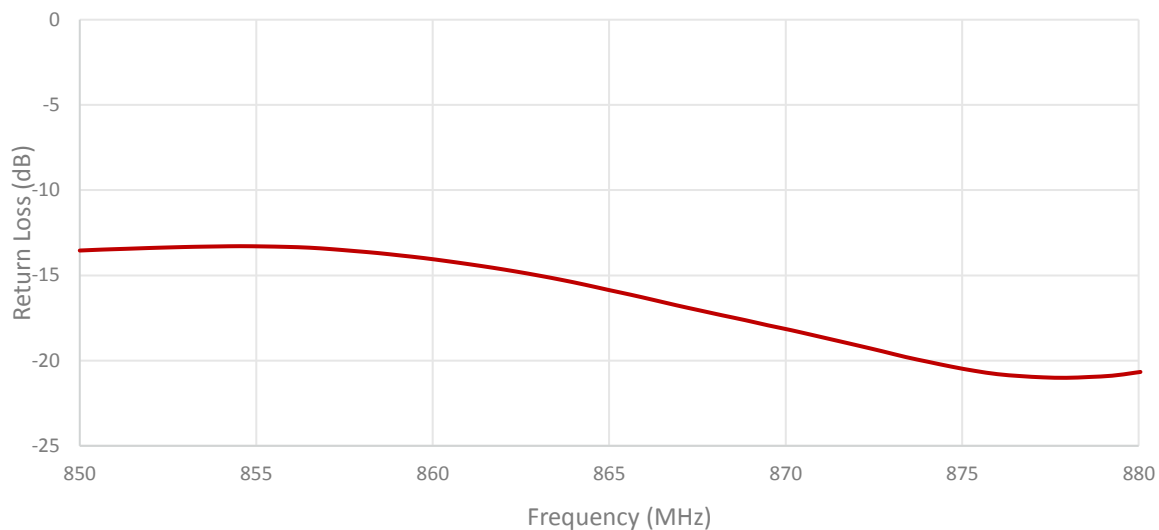

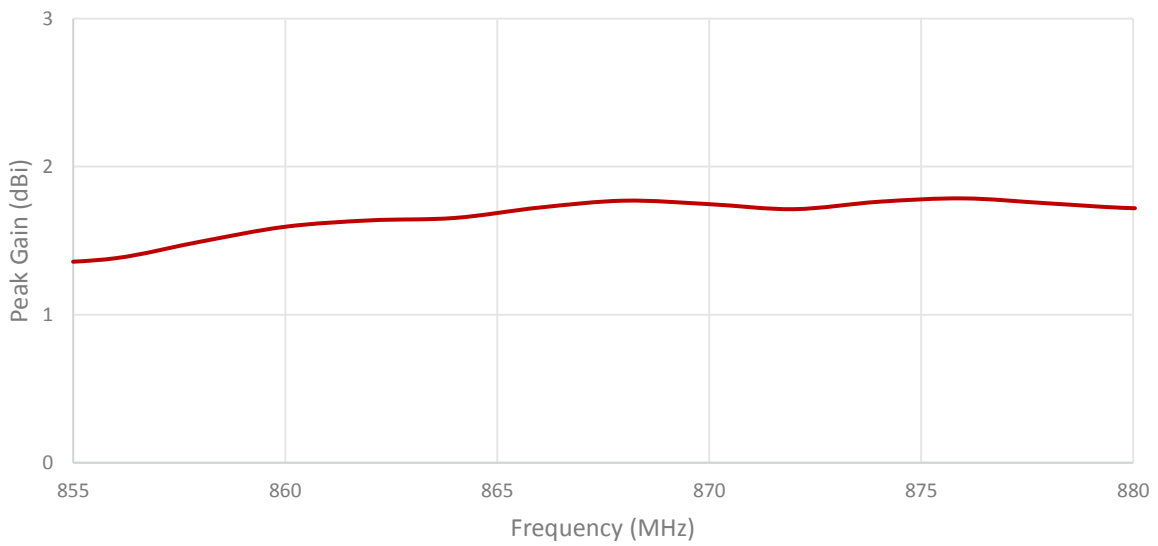
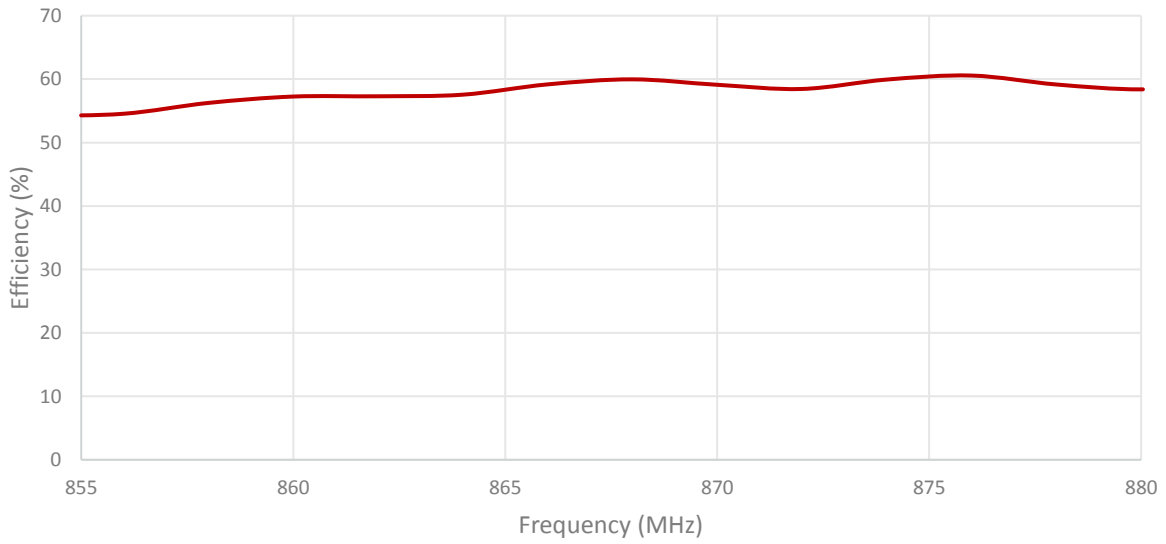

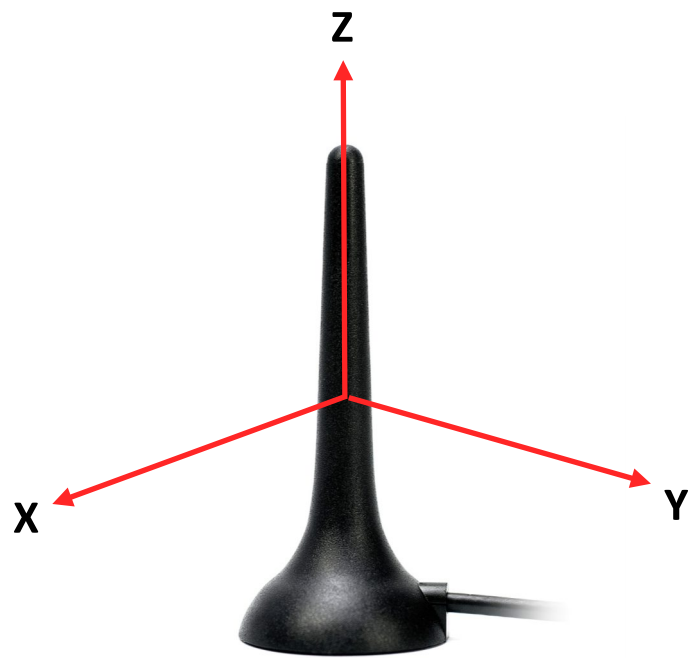
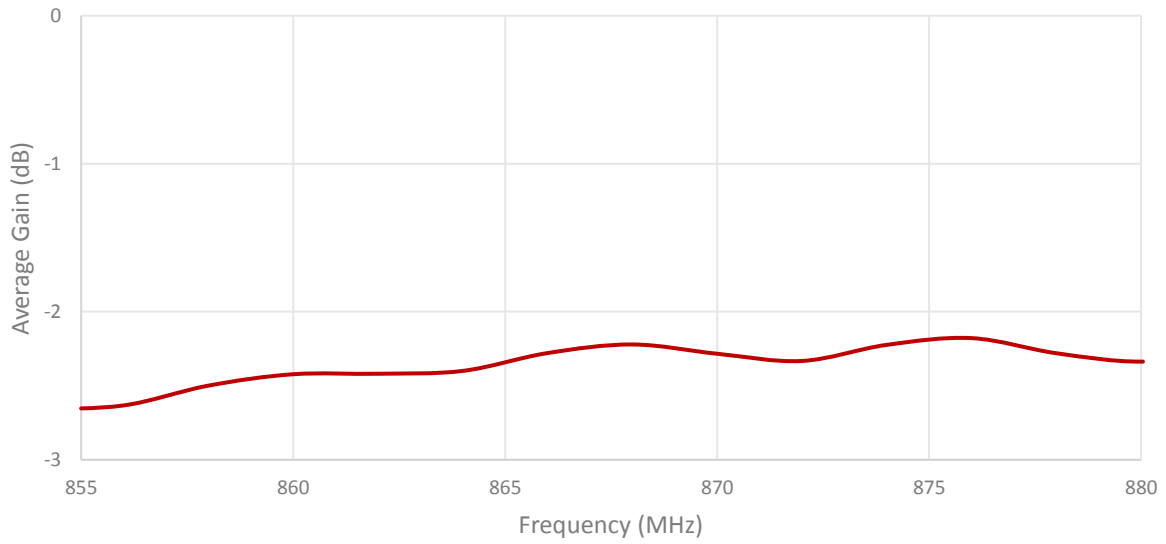

Radiation pattern reference

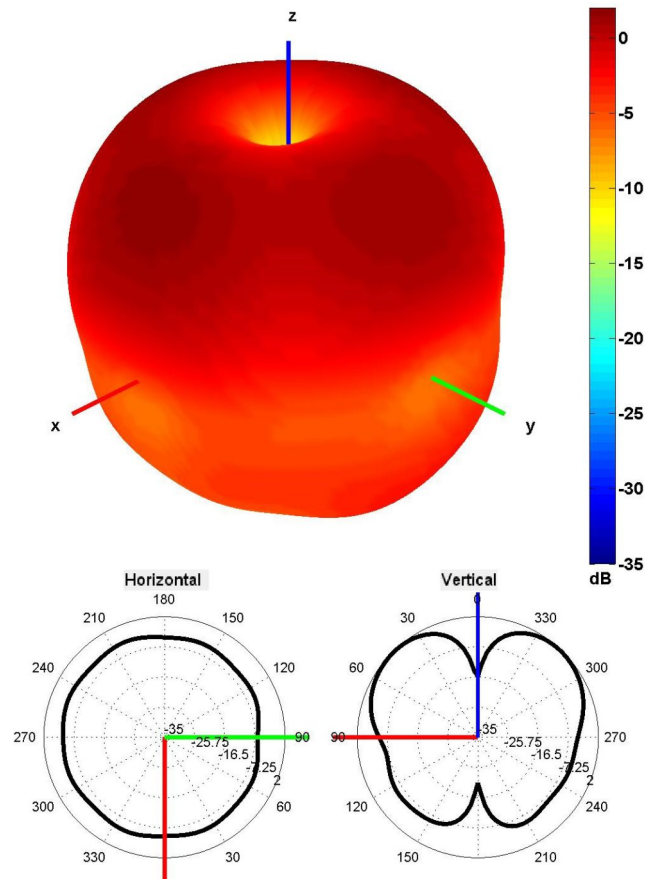

868 MHz Radiation pattern

## 4. Antenna drawings

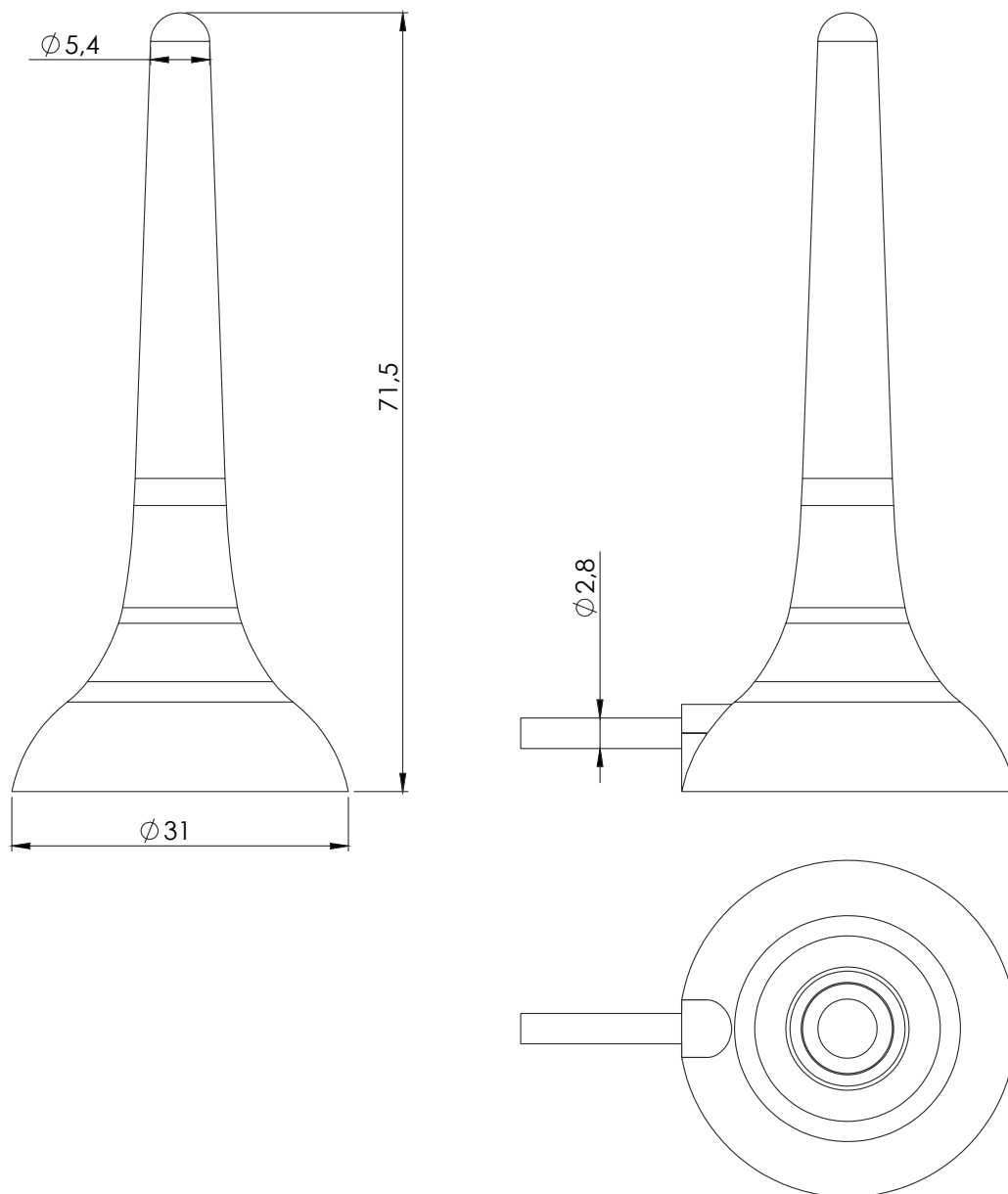

## 5. Antenna Images

