

Series SK (2.92 mm standard) – prec. submini. connectors

Description

HUBER+SUHNER SK connectors are precision connectors for microwave applications up to 40 GHz.

They are intermateable with series SMA and PC 3.5. They have a high mechanical stability and an excellent repeatability. The shortened male pin ensures a non-destructive mating process. The glass beads, when used in conjunction with the SK launchers, enable the connectors to be replaced without disturbing the hermetic seal.

For a mechanical decoupling between glass bead and internal microwave circuit, stress relief contacts are available.

Content

| | |
|-----------------------------------|-----|
| Description | 209 |
| Interface dimensions in mm/inches | 209 |
| Technical data | 210 |
| Cable connectors | 211 |
| Launchers | 212 |
| Accessories | 213 |

Interface dimensions (mm/inches)

Plug (male)

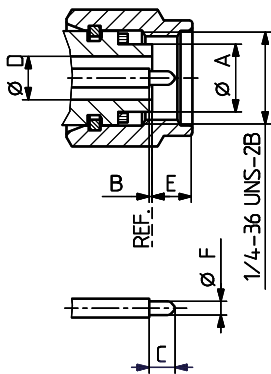

| | Plug | | Jack | |
|---|------------|------------|------------|------------|
| | min. | max. | min. | max. |
| A | 4.53/0.178 | 4.57/0.180 | 4.60/0.181 | 4.64/0.183 |
| B | 0.00/0.000 | 0.13/0.005 | 0.00/0.000 | 0.13/0.005 |
| C | 1.55/0.061 | 1.65/0.065 | 2.80/0.110 | - |
| D | 2.89/0.114 | 2.95/0.116 | 2.89/0.114 | 2.95/0.116 |
| E | - | 3.28/0.129 | 1.88/0.074 | 1.98/0.078 |
| F | 0.91/0.036 | 0.94/0.037 | 5.90/0.232 | - |
| G | - | - | 4.40/0.173 | - |
| H | - | - | 0.70/0.028 | 0.90/0.036 |
| I | - | - | 5.30/0.208 | 5.40/0.213 |

Jack (female)

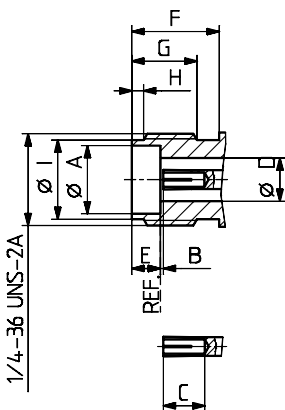

Series SK (2.92 mm standard) – technical data

SK (2.92 mm)

| Electrical data | Requirements |
|--|--|
| Impedance | 50 Ω |
| Frequency range | DC to 40 GHz |
| Dielectric withstanding voltage (at sea level) | 750 V rms, 50 Hz |
| Working voltage (at sea level) mated/unmated | ≤ 250 V rms, 50 Hz |
| Insulation resistance | ≥ 5 · 10 ³ MΩ |
| Contact resistance <ul style="list-style-type: none"> • Centre contact • Outer contact | ≤ 3 mΩ ≤ 2 mΩ |
| VSWR (typical values) <ul style="list-style-type: none"> • Cable connectors (cable assembly with 2 connectors) • Launchers | ≤ 1.37 DC to 40 GHz ≤ 1.43 DC to 40 GHz |

| Mechanical data | Requirements |
|---|----------------------|
| Coupling nut torque <ul style="list-style-type: none"> • Recommended | 1.30 Nm/11.47 in lbs |
| Contact captivation | ≥ 27 N/4.9 lbs |
| Durability (matings) | ≥ 500 |

| Environmental data | Requirements |
|--------------------|--------------------------------------|
| Temperature range | −40 to +125 °C/−40 to +257 °F |
| Thermal shock | MIL-STD-202, method 107, condition B |
| Vibration | MIL-STD-202, method 204, condition D |

| Material data | | |
|--------------------------|--|-----------------|
| Connector parts | Material | Plating |
| Bodies, cable connectors | copper beryllium alloy/stainless steel | gold |
| Bodies, receptacles | stainless steel/copper alloy | passivated/gold |
| Centre contacts | copper beryllium alloy | gold |
| Support beads | PPO (polyphenylene oxide) | |

Some connectors may have a specification that differs from the above mentioned data.

The products are designed and guaranteed to pass the above mentioned test procedures. Any additional or different requirement arising from specific applications or environmental conditions which is not covered by these test procedures is subject to request.

Series SK (2.92 mm standard) – cable connectors

Straight cable plugs (male)

For semi-rigid cables

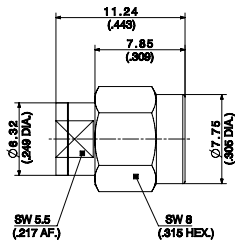

Fig. 1

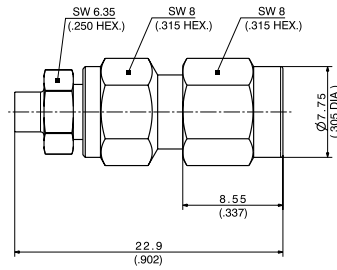

Fig. 2



SK (2.92 mm)

| HUBER+SUHNER type | Item no. | Cable group (example) | Packaging | Assembly instruction | Fig. | Notes |
|----------------------|----------|-----------------------|-----------|----------------------|------|-------|
| 11_SK-50-2-56/119_NE | 84013230 | Y16 (EZ_86) | single | 27445 | 1 | plug |
| 11_SK-50-2-60/199_NE | 84098644 | Y11 (MF_86) | | 0000331903 | 2 | plug |

Straight cable jacks (female)

For semi-rigid cables

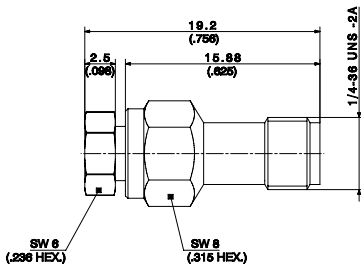

Fig. 1

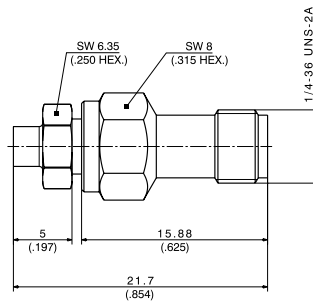

Fig. 2



| HUBER+SUHNER type | Item no. | Cable group (example) | Packaging | Assembly instruction | Fig. | Notes |
|----------------------|----------|-----------------------|-----------|----------------------|------|-------|
| 21_SK-50-2-58/199_NE | 84019664 | Y16 (EZ_86) | single | 0000234990 | 1 | jack |
| 21_SK-50-2-61/199_NE | 84094378 | Y11 (MF_86) | | 0000326138 | 2 | jack |

Series SK (2.92 mm standard) – cable connectors

Straight bulkhead cable jacks (female)

For semi-rigid cables

- with panel seal

SK (2.92 mm)

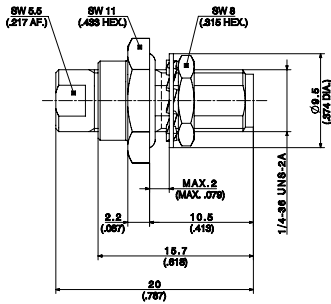

| HUBER+SUHNER type | Item no. | Cable group (example) | Packaging | Assembly instruction | Mounting hole | Fig. |
|----------------------|----------|-----------------------|-----------|----------------------|---------------|------|
| 24_SK-50-2-55/1--_NE | 84016419 | Y10 (EZ_118-TP) | single | 0000229976 | ML 35 | 1 |

Series SK (2.92 mm standard) – launchers

"Spark plug" launchers

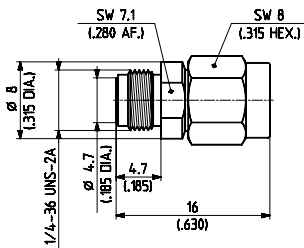

Fig. 1

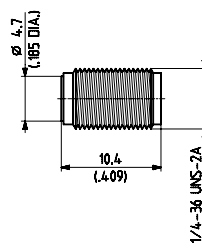

Fig. 2



| HUBER+SUHNER type | Item no. | Packaging | Assembly instruction | Mounting hole | Notes | Fig. |
|----------------------|----------|-----------|----------------------|---------------|-------|------|
| 12_SK-50-0-51/199_NE | 22645974 | single | 9181 | ML 75 | plug | 1 |
| 22_SK-50-0-51/199_NE | 22645975 | single | 9181 | ML 75 | jack | 2 |

Series SK (2.92 mm standard) – launchers

Panel launchers (male)

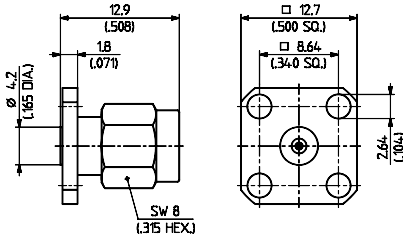

Fig. 1

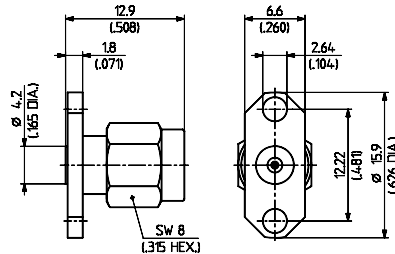

Fig. 2



| HUBER+SUHNER type | Item no. | Packaging | Assembly instruction | Mounting hole | Flange type | Fig. |
|----------------------|----------|-----------|----------------------|---------------|-------------|------|
| 13_SK-50-0-51/199_NE | 22645978 | single | 9182 | ML77 | square | 1 |
| 13_SK-50-0-52/199_NE | 22645976 | single | 9182 | ML78 | 2-hole | 2 |

Panel launchers (male)

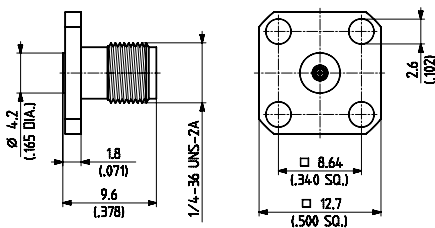

Fig. 1

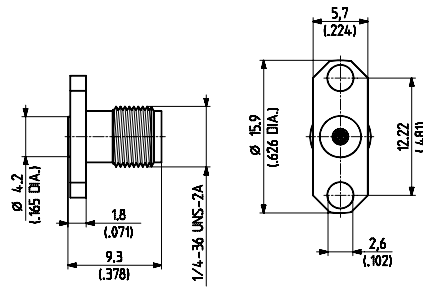

Fig. 2



| HUBER+SUHNER type | Item no. | Packaging | Assembly instruction | Mounting hole | Flange type | Fig. |
|----------------------|----------|-----------|----------------------|---------------|-------------|------|
| 23_SK-50-0-51/199_NE | 22645979 | single | 9182 | ML77 | square | 1 |
| 23_SK-50-0-52/199_NE | 22645977 | single | 9182 | ML78 | 2-hole | 2 |

Series SK (2.92 mm standard) – accessories

Glass bead for 12 SK, 13 SK, 22 SK, 23 SK launchers
(package with 1 piece)

Microstrip stress relief contacts
(package with 100 pieces)

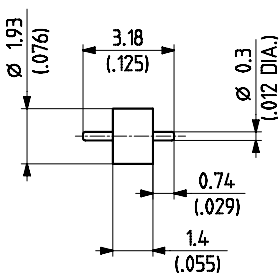

HUBER+SUHNER type
73_Z-0-0-203/11_NE
Item no. 22645983

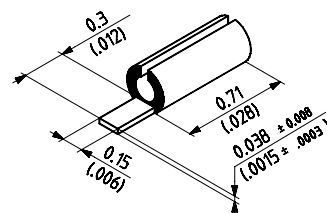

HUBER+SUHNER type
73_Z-0-0-204/1--_NH
Item no. 22645980