

4 PIN DIP HIGH VOLTAGE PHOTODARLINGTON PHOTOCOUPLER EL852 Series

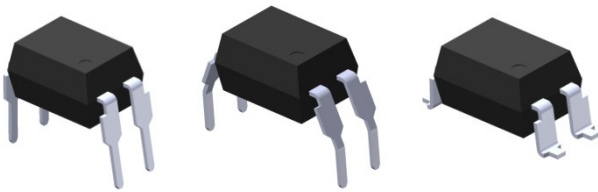

Schematic

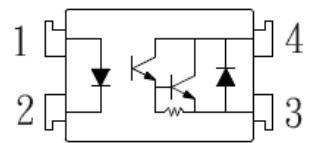

Pin Configuration

1. Anode
2. Cathode
3. Emitter
4. Collector

Features:

- High collector- emitter voltage ($V_{CEO}=350V$)
- Current transfer ratio (CTR: 1000% min. at $I_F = 1mA$, $V_{CE} = 2V$)
- High isolation voltage between input and output ($V_{iso}=5000 V rms$)
- Creepage distance $>7.62 mm$
- Operating temperature up to $+110^{\circ}C$
- Compact small outline package
- Pb free and RoHS compliant.
- UL approved
- VDE approved
- SEMKO approved
- NEMKO approved
- DEMKO approved
- FIMKO approved

Description

The EL852 series consists an infrared emitting diodes, optically coupled to a high voltage photo Darlington detector.

It is packaged in a 4-pin DIP package and available in wide-lead spacing and SMD option.

Applications

- Telephone set, telephone exchangers
- Sequence controllers
- System appliances, measuring instruments
- Signal transmission between circuits of different potentials and impedances

Absolute Maximum Ratings (Ta=25°C)

	Parameter	Symbol	Rating	Unit
Input	Forward current	I_F	60	mA
	Peak forward current (1us, pulse)	I_{FP}	1	A
	Reverse voltage	V_R	6	V
	Power dissipation No derating required up to Ta = 100°C	P_D	100	mW
Output	Power dissipation	P_C	300	mW
	Derating factor (above Ta = 80°C)		5.8	mW/°C
	Collector current	I_C	150	mA
	Collector-Emitter voltage	V_{CEO}	350	V
	Emitter-Collector voltage	V_{ECO}	0.1	V
Total power dissipation	P_{TOT}	200	mW	
Isolation voltage ^{*1}	V_{ISO}	5000	V rms	
Operating temperature	T_{OPR}	-55 ~ +110	°C	
Storage temperature	T_{STG}	-55 ~ +125	°C	
Soldering Temperature ^{*2}	T_{SOL}	260	°C	

Notes:

*1 AC for 1 minute, R.H.= 40 ~ 60% R.H. In this test, pins 1 & 2 are shorted together, and pins 3 & 4 are shorted together.

*2 For 10 seconds

Electro-Optical Characteristics (Ta=25°C unless specified otherwise)

Input

Parameter	Symbol	Min.	Typ.*	Max.	Unit	Condition
Forward Voltage	V_F	-	1.2	1.4	V	$I_F = 10\text{mA}$
Reverse Current	I_R	-	-	10	μA	$V_R = 4\text{V}$
Input capacitance	C_{in}	-	30	250	pF	$V = 0, f = 1\text{kHz}$

Output

Parameter	Symbol	Min.	Typ.*	Max.	Unit	Condition
Collector-Emitter dark current	I_{CEO}	-	-	200	nA	$V_{CE} = 200\text{V}, I_F = 0\text{mA}$
Collector-Emitter breakdown voltage	BV_{CEO}	350	-	-	V	$I_C = 0.1\text{mA}$
Emitter-Collector breakdown voltage	BV_{ECO}	0.1	-	-	V	$I_E = 0.1\text{mA}$

Transfer Characteristics

Parameter	Symbol	Min.	Typ.*	Max.	Unit	Condition
Current Transfer ratio	CTR	1000	-	15000	%	$I_F = 1\text{mA}, V_{CE} = 2\text{V}$
Collector-Emitter saturation voltage	$V_{CE(sat)}$	-	-	1.2	V	$I_F = 20\text{mA}, I_C = 100\text{mA}$
Isolation resistance	R_{IO}	5×10^{10}	-	-	Ω	$V_{IO} = 500\text{Vdc}, 40\sim 60\% \text{ R.H.}$
Floating capacitance	C_{IO}	-	0.6	1.0	pF	$V_{IO} = 0, f = 1\text{MHz}$
Cut-off frequency	f_c	-	7	-	kHz	$V_{CE} = 2\text{V}, I_C = 20\text{mA}, R_L = 100\Omega, -3\text{dB}$
Rise time	t_r	-	-	300	μs	$V_{CE} = 2\text{V}, I_C = 20\text{mA}, R_L = 100\Omega$
Fall time	t_f	-	-	100	μs	

* Typical values at $T_a = 25^\circ\text{C}$

Typical Electro-Optical Characteristics Curves

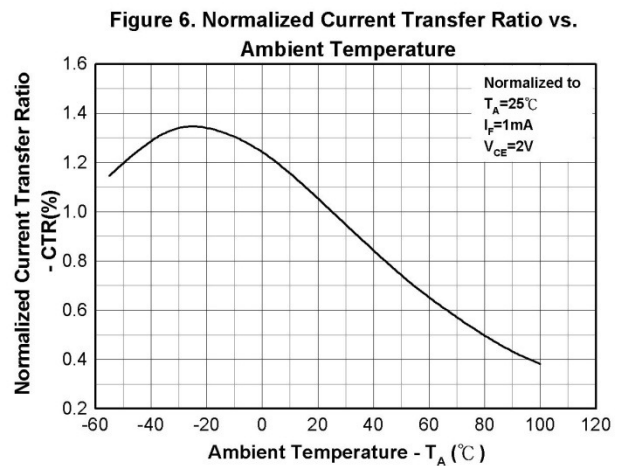
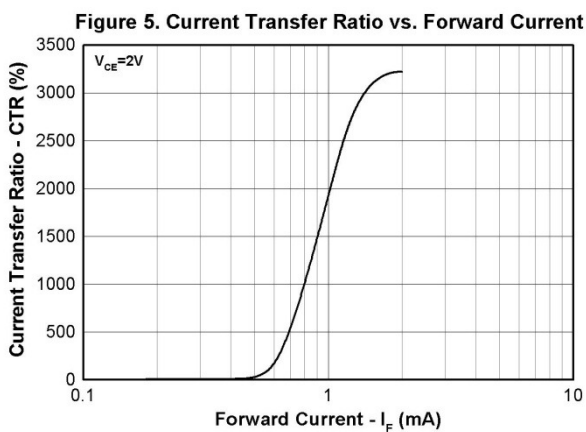
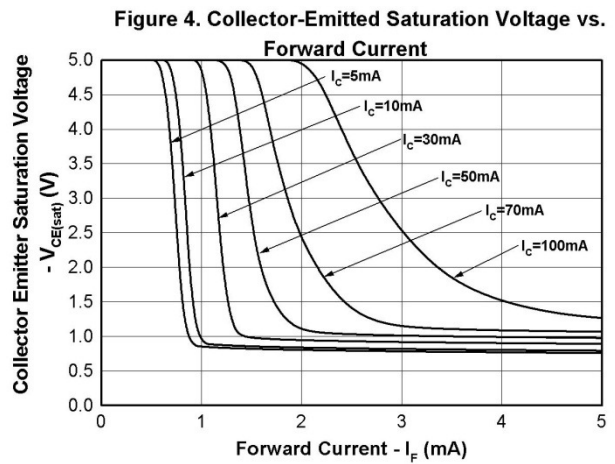
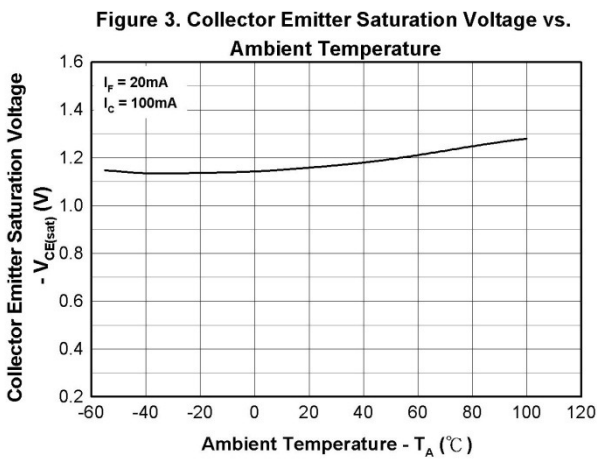
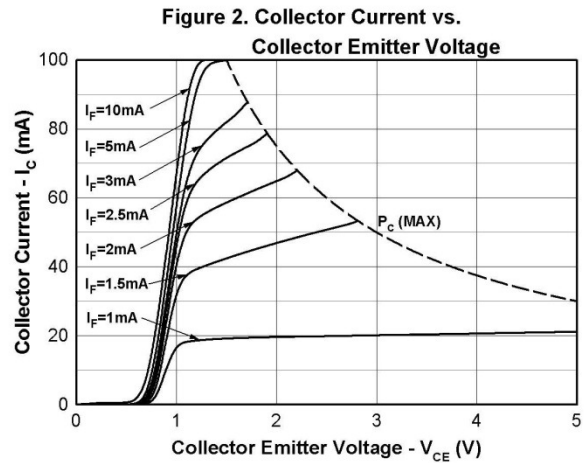
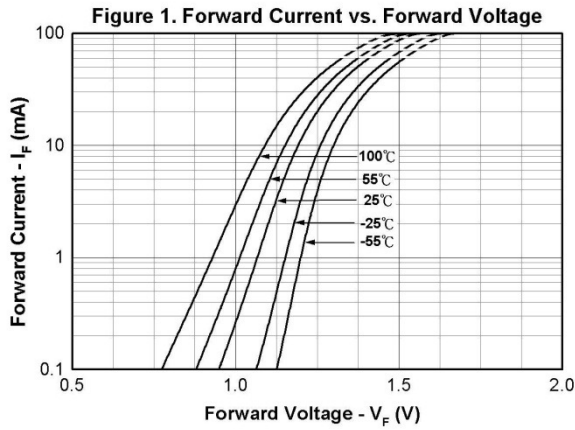

Figure 7. Collector Dark Current vs. Ambient Temperature

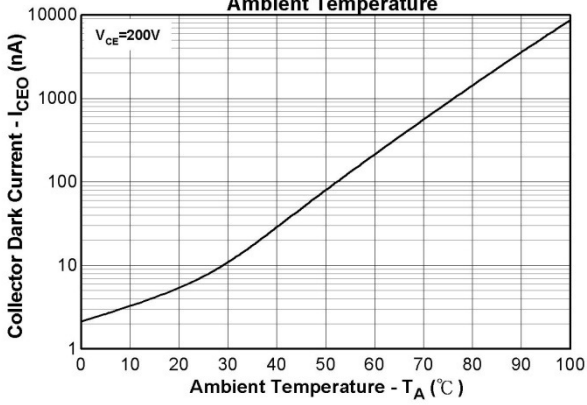

Figure 8. Response Time vs. Load Resistance

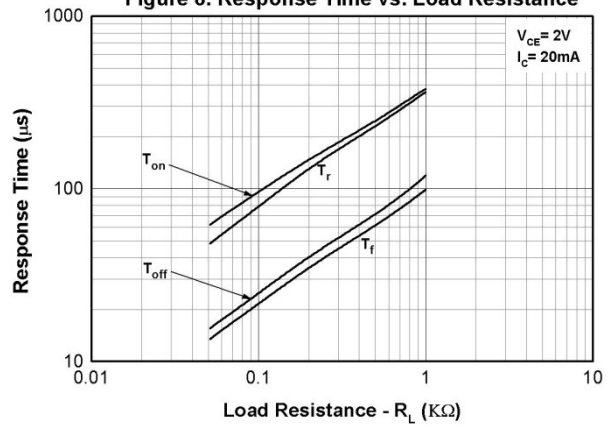
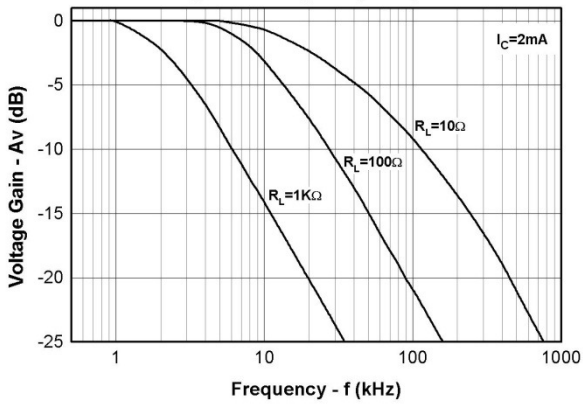

Figure 9. Frequency Response



**Order Informatio
Part Number**

EL852X(Y)-V

Note

- X = Lead form option (S, S1, M or none)
- Y = Tape and reel option (TA, TB ,TU, TD or none).
- V = VDE safety (optional).

Option	Description	Packing quantity
None	Standard DIP-4	100 units per tube
M	Wide lead bend (0.4 inch spacing)	100 units per tube
S (TA)	Surface mount lead form + TA tape & reel option	1000 units per reel
S (TB)	Surface mount lead form + TB tape & reel option	1000 units per reel
S1 (TA)	Surface mount lead form (low profile) + TA tape & reel option	1000 units per reel
S1 (TB)	Surface mount lead form (low profile) + TB tape & reel option	1000 units per reel
S (TU)	Surface mount lead form + TU tape & reel option	1500 units per reel
S (TD)	Surface mount lead form + TD tape & reel option	1500 units per reel
S1 (TU)	Surface mount lead form (low profile) + TU tape & reel option	1500 units per reel
S1 (TD)	Surface mount lead form (low profile) + TD tape & reel option	1500 units per reel

Package Dimension (Dimensions in mm)

Standard DIP Type

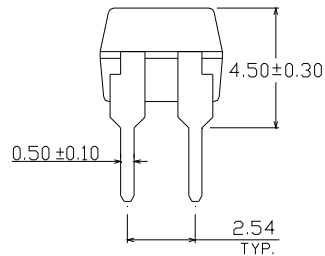
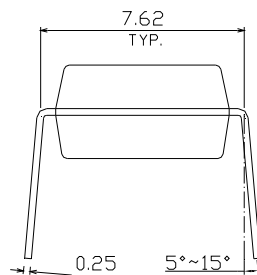
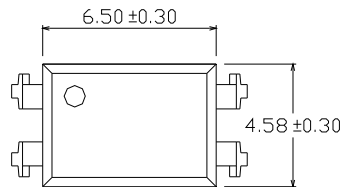

Option M Type

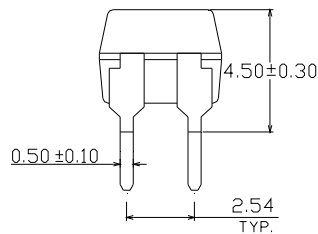
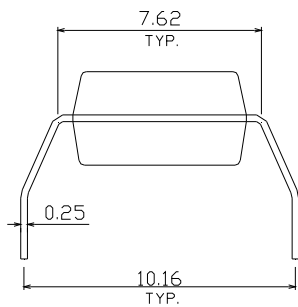
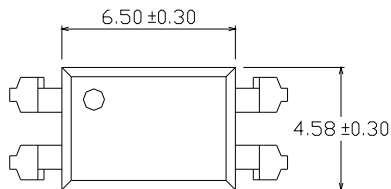

Option S Type

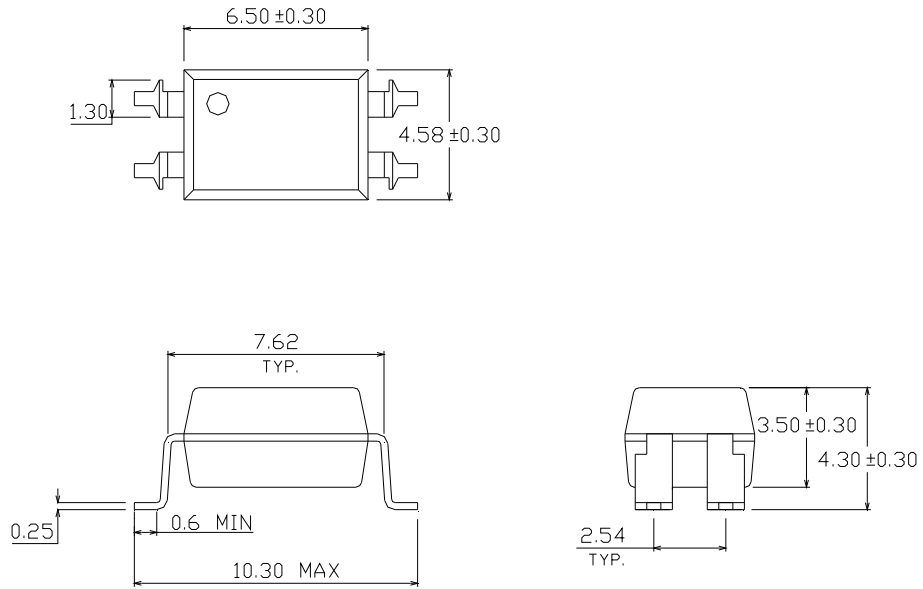

Option S1 Type

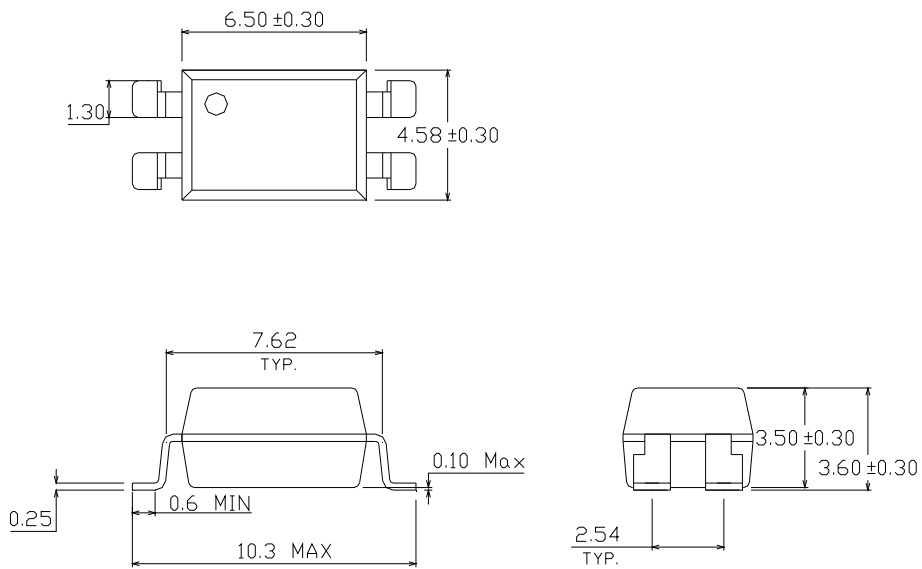

Recommended pad layout for surface mount leadform

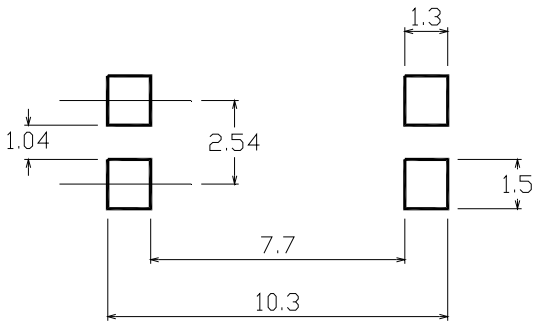

Device Marking



Notes

- EL denotes EVERLIGHT
- 852 denotes Device Number
- Y denotes 1 digit Year code
- WW denotes 2 digit Week code
- V denotes VDE optional

Tape & Reel Packing Specifications

Option TA

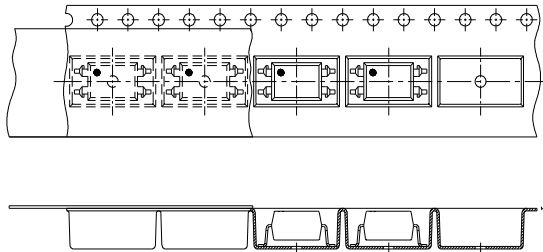

Direction of feed from reel

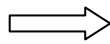

Option TB

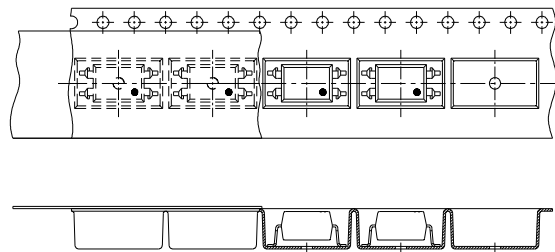

Direction of feed from reel

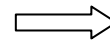

Tape dimensions

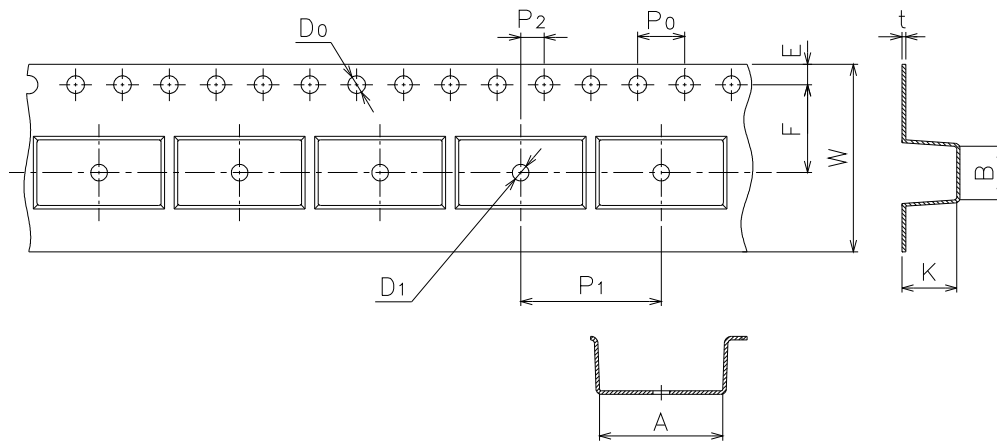

Dimension No.	A	B	Do	D1	E	F
Dimension(mm)	10.5±0.1	4.65±0.1	1.55±0.1	1.50±0.1	1.75±0.1	7.5±0.1
Dimension No.	Po	P1	P2	t	W	K
Dimension(mm)	4.0±0.1	12.0±0.1	2.0±0.1	0.35±0.1	16.0±0.3	4.75±0.1

Option TD

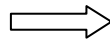
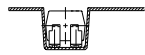
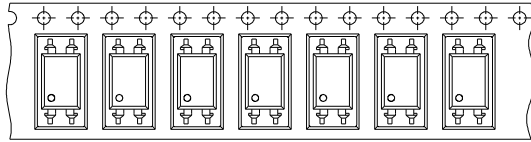

Direction of feed from reel

Option TU

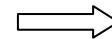
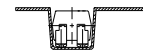
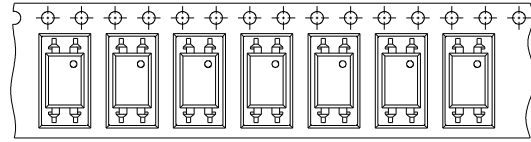

Direction of feed from reel

Tape dimensions

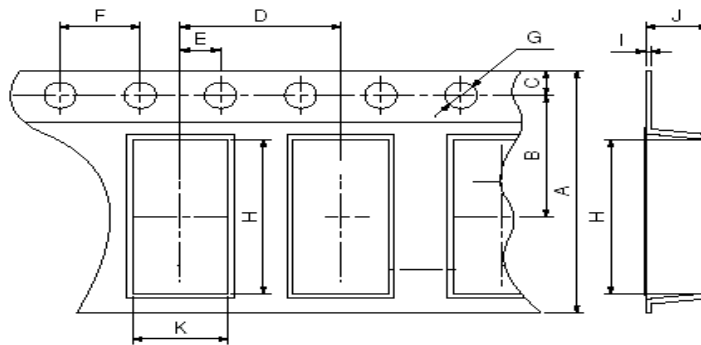

Dimension No.	A	B	C	D	E	F
Dimension(mm)	16.00±0.3	7.5±0.1	1.75±0.1	8.0±0.1	2.0±0.1	4.0±0.1
Dimension No.	G	H	I	J	K	
Dimension(mm)	1.55±0.05	10.4±0.1	0.4±0.05	4.60±0.1	5.1±0.1	

Precautions for Use

1. Soldering Condition

1.1 (A) Maximum Body Case Temperature Profile for evaluation of Reflow Profile

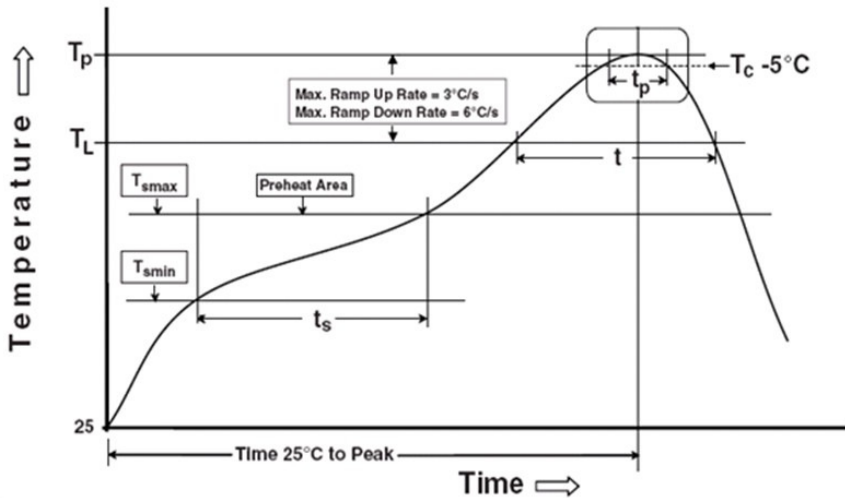

Note:

Reference: IPC/JEDEC J-STD-020D

Preheat

Temperature min (T_{smin})	150 °C
Temperature max (T_{smax})	200 °C
Time (T_{smin} to T_{smax}) (t_s)	60-120 seconds
Average ramp-up rate (T_{smax} to T_p)	3 °C/second max

Other

Liquidus Temperature (T_L)	217 °C
Time above Liquidus Temperature (t_L)	60-100 sec
Peak Temperature (T_p)	260 °C
Time within 5 °C of Actual Peak Temperature: $T_p - 5^\circ\text{C}$	30 s
Ramp- Down Rate from Peak Temperature	6 °C /second max.
Time 25 °C to peak temperature	8 minutes max.
Reflow times	3 times

DISCLAIMER

1. Above specification may be changed without notice. EVERLIGHT will reserve authority on material change for above specification.
2. When using this product, please observe the absolute maximum ratings and the instructions for using outlined in these specification sheets. EVERLIGHT assumes no responsibility for any damage resulting from use of the product which does not comply with the absolute maximum ratings and the instructions included in these specification sheets.
3. These specification sheets include materials protected under copyright of EVERLIGHT corporation. Please don't reproduce or cause anyone to reproduce them without EVERLIGHT's consent.