

Product name	Description	Version
LS26030-B	GNSS module of PCIe Full-Mini card	1.2
LS26031-B	GNSS module of PCIe Half-Mini card	



1 Introduction

LOCOSYS LS26030-B and LS26031-B are GNSS modules incorporated into the PCIe Full-Mini card or PCIe Half-Mini card. These GNSS modules are powered by MediaTek, it can provide you with superior sensitivity and performance even in urban canyon and dense foliage environment. Besides, the USB interface makes these modules easy to integrate into the laptop.

These modules support hybrid ephemeris prediction to achieve faster cold start. One is self-generated ephemeris prediction that is no need of both network assistance and host CPU's intervention. This is valid for up to 3 days and updates automatically from time to time when GNSS module is powered on and satellites are available. The other is server-generated ephemeris prediction that gets from an internet server. This is valid for up to 14 days. Both ephemeris predictions are stored in the on-board flash memory and perform a cold start time less than 15 seconds.

2 Features

- USB interface
- MediaTek high sensitivity solution
- Support GPS, BEIDOU, GALILEO and QZSS
- Capable of SBAS (WAAS, EGNOS, MSAS, GAGAN)
- Support 99-channel GNSS
- Low power consumption
- Fast TTFF at low signal level
- Built-in 12 multi-tone active interference canceller
- Free hybrid ephemeris prediction to achieve faster cold start
- Built-in data logger
- Up to 10 Hz update rate
- ± 1 ns high accuracy time pulse (1PPS)
- Indoor and outdoor multi-path detection and compensation
- Built-in LNA and SAW filter
- Built-in micro battery to reserve system data for rapid satellite acquisition

3 Application

- Laptop with GNSS function
- IPC with GNSS function

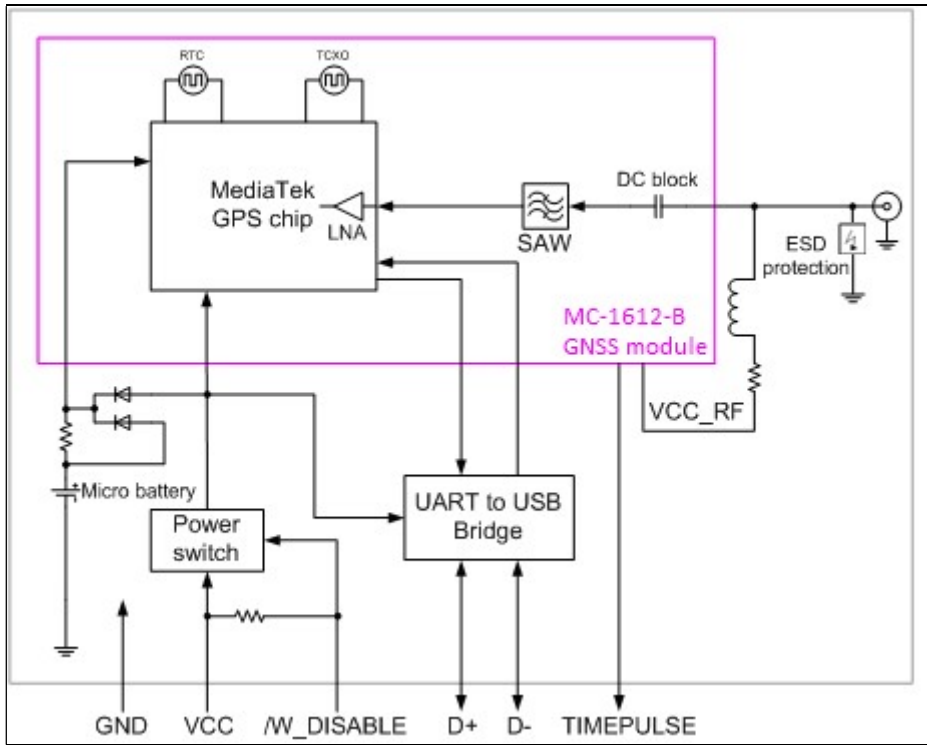

Fig 3-1 System block diagram.

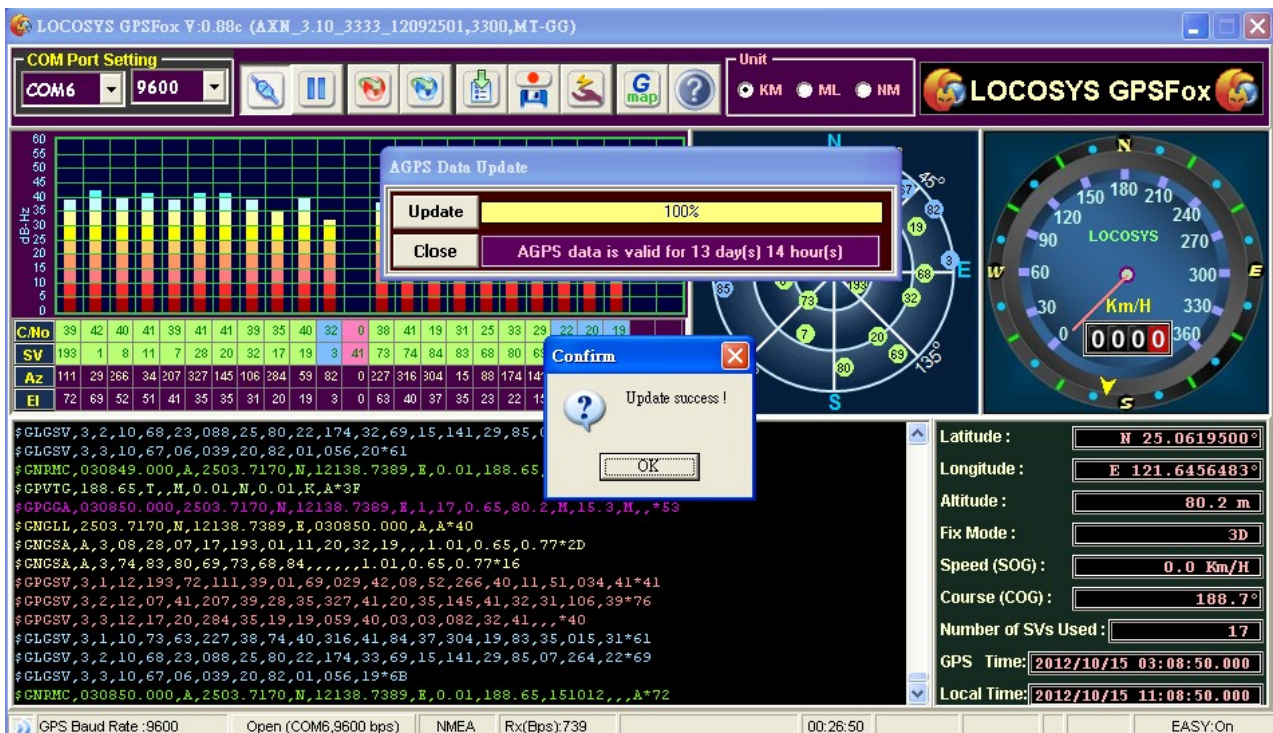

Fig 3-2 Download free up-to-14-day AGPS data from LOCOSYS' server to get faster time to fix.

4 GNSS receiver

Chip	MediaTek MT3333	
Frequency	GPS, GALILEO, QZSS: L1 1575.42MHz, C/A code BEIDOU: B1 1561.098MHz, C code	
Channels	Support 99 channels (33 Tracking, 99 Acquisition)	
Update rate	1Hz default, up to 10Hz	
Sensitivity	Tracking	Up to -165dBm (with external LNA)
	Cold start	Up to -148dBm (with external LNA)
Acquisition Time	Hot start (Open Sky)	1s (typical)
	Hot start (Indoor)	< 30s (typical)
	Cold Start (Open Sky)	33s (typical) without AGPS
< 15s (typical) with AGPS (hybrid ephemeris prediction)		
Position Accuracy	Autonomous	2.5m CEP
	SBAS	2.5m (depends on accuracy of correction data).
Max. Altitude	< 18,000 m, up to 50,000m by request	
Max. Velocity	< 515 m/s	
Protocol Support	NMEA 0183 ver 4.00 ⁽¹⁾	9600 bps ⁽²⁾ , 8 data bits, no parity, 1 stop bits (default) 1Hz: GGA, GLL, GSA, GSV, RMC, VTG

Note (1): The default NMEA version is 4.00 and it also can configure to 4.10. If customers want to the product to support 4.10 please contact us in advance.

Note (2): Both baud rate and output message rate are configurable to be factory default.

5 Software interface

5.1 NMEA output message

Table 5.1-1 NMEA output message

NMEA record	Description
GGA	Global positioning system fixed data
GLL	Geographic position - latitude/longitude
GSA	GNSS DOP and active satellites
GSV	GNSS satellites in view
RMC	Recommended minimum specific GNSS data
VTG	Course over ground and ground speed

● GGA--- Global Positioning System Fixed Data

Table 5.1-2 contains the values for the following example:

\$GNGGA,183015.000,2503.7123,N,12138.7446,E,2,16,0.68,123.2,M,15.3,M,,*78

Table 5.1-2 GGA Data Format

Name	Example	Units	Description
Message ID	\$GNGGA		GGA protocol header
UTC Time	183015.000		hhmmss.sss
Latitude	2503.7123		ddmm.mmmm
N/S indicator	N		N=north or S=south
Longitude	12138.7446		dddmm.mmmm
E/W Indicator	E		E=east or W=west
Position Fix Indicator	2		See Table 5.1-3
Satellites Used	16		Range 0 to 33
HDOP	0.68		Horizontal Dilution of Precision
MSL Altitude	123.2	meters	
Units	M	meters	
Geoid Separation	15.3	meters	
Units	M	meters	
Age of Diff. Corr.		second	Null fields when DGPS is not used
Diff. Ref. Station ID			
Checksum	*78		
<CR> <LF>			End of message termination

Table 5.1-3 Position Fix Indicators

Value	Description
0	Fix not available or invalid
1	GPS SPS Mode, fix valid
2	Differential GPS, SPS Mode, fix valid
3-5	Not supported
6	Dead Reckoning Mode, fix valid

● GLL--- Geographic Position – Latitude/Longitude

Table 5.1-4 contains the values for the following example:

\$GNGLL,2503.7135,N,12138.7448,E,055757.000,A,D*45

Table 5.1-4 GLL Data Format

Name	Example	Units	Description
Message ID	\$GNGLL		GLL protocol header
Latitude	2503.7135		ddmm.mmmm
N/S indicator	N		N=north or S=south
Longitude	12138.7448		dddmm.mmmm
E/W indicator	E		E=east or W=west
UTC Time	055757.000		hhmmss.sss

Status	A		A=data valid or V=data not valid
Mode	D		N = No position fix A = Autonomous GNSS fix D = Differential GNSS fix R = RTK fixed F = RTK float E = Estimated/Dead reckoning fix
Checksum	*45		
<CR> <LF>			End of message termination

● GSA---GNSS DOP and Active Satellites

Table 5.1-5 contains the values for the following example:

NMEA V4.0

\$GPGSA,A,3,09,06,17,195,193,19,02,05,,,,,1.07,0.71,0.80*0A

\$BDGSA,A,3,13,01,02,09,30,08,27,28,07,06,,,,,1.07,0.71,0.80*16

NMEA V4.10

\$GNGSA,A,3,06,09,02,12,28,19,05,04,17,,,,,0.93,0.60,0.72,1*03

\$GNGSA,A,3,03,07,02,08,10,01,13,09,27,28,30,,0.93,0.60,0.72,4*04

Table 5.1-5 GSA Data Format

Name	Example	Units	Description
Message ID	\$GNGSA		GSA protocol header, GP=GPS/QZSS, GL=GLONASS, GA=GALILEO, BD=BEIDOU (GN for NMEA Ver 4.10)
Mode 1	A		See Table 5.1-6
Mode 2	3		See Table 5.1-7
ID of satellite used	06		Sv on Channel 1
ID of satellite used	09		Sv on Channel 2
....		
ID of satellite used			Sv on Channel 12
PDOP	0.93		Position Dilution of Precision
HDOP	0.60		Horizontal Dilution of Precision
VDOP	0.72		Vertical Dilution of Precision
System ID	1		1: GPS, 2:GLONASS, 3:GALILEO, 4:BEIDOU (NMEA Ver 4.10 support only)
Checksum	*03		
<CR> <LF>			End of message termination

Table 5.1-6 Mode 1

Value	Description
M	Manual- forced to operate in 2D or 3D mode
A	Automatic-allowed to automatically switch 2D/3D

Table 5.1-7 Mode 2

Value	Description
1	Fix not available
2	2D
3	3D

● GSV---GNSS Satellites in View

Table 5.1-8 contains the values for the following example:

```
$GPGSV,3,1,11,19,72,094,35,50,60,167,31,17,55,123,34,06,50,013,37,0*64
$GPGSV,3,2,11,02,38,318,31,09,38,077,28,05,37,240,35,12,24,300,28,0*60
$GPGSV,3,3,11,04,14,048,24,28,11,175,26,25,02,320,,0*57
$BDGSV,4,1,16,27,65,067,45,03,60,206,41,01,51,136,38,08,50,349,35,0*7B
$BDGSV,4,2,16,10,43,228,38,13,41,314,40,30,40,328,40,02,39,242,37,0*77
$BDGSV,4,3,16,04,39,117,36,07,35,200,36,06,27,171,31,16,24,175,,0*7A
$BDGSV,4,4,16,20,24,216,,28,21,115,37,05,16,258,,09,10,189,33,0*7F
```

Table 5.1-8 GSV Data Format

Name	Example	Units	Description
Message ID	\$GPGSV		GSV protocol header GP=GPS/QZSS, GL=GLONASS, GA=GALILEO, BD=BEIDOU
Total number of messages ⁽¹⁾	3		Range 1 to 6
Message number ⁽¹⁾	1		Range 1 to 6
Satellites in view	11		
Satellite ID ⁽²⁾	19		Channel 1 (Range 01 to 196)
Elevation	72	degrees	Channel 1 (Range 00 to 90)
Azimuth	094	degrees	Channel 1 (Range 000 to 359)
SNR (C/No)	35	dB-Hz	Channel 1 (Range 00 to 99, null when not tracking)
....		
Satellite ID	06		Channel 4 (Range 01 to 196)
Elevation	50	degrees	Channel 4 (Range 00 to 90)
Azimuth	013	degrees	Channel 4 (Range 000 to 359)
SNR (C/No)	37	dB-Hz	Channel 4 (Range 00 to 99, null when not tracking)
Signal ID	0		GPS/QZSS: All signal=0,

			GLONASS: All signal=0, G1 C/A=1 GALILEO: All signal=0, BEIDOU: All signal=0 NMEA Ver 4.10 support only
Checksum	*64		
<CR> <LF>			End of message termination

Note (1): Depending on the number of satellites tracked multiple messages of GSV data may be required.

Note (2): GPS ID: 01~32, SBAS ID: 33~64, QZSS ID: 193~196, BEIDOU ID: 01~32, GALILEO ID: 01~32.

● RMC---Recommended Minimum Specific GNSS Data

Table 5.1-9 contains the values for the following example:

\$GNRMC,183015.000,A,2503.7123,N,12138.7446,E,0.01,34.92,270812,,D,V*39

Table 5.1-9 RMC Data Format

Name	Example	Units	Description
Message ID	\$GNRMC		RMC protocol header
UTC Time	183015.000		hhmmss.sss
Status	A		A=data valid or V=data not valid
Latitude	2503.7123		ddmm.mmmm
N/S Indicator	N		N=north or S=south
Longitude	12138.7446		dddmm.mmmm
E/W Indicator	E		E=east or W=west
Speed over ground	0.01	knots	True
Course over ground	34.92	degrees	
Date	270812		ddmmyy
Magnetic variation		degrees	
Variation sense			E=east or W=west (Not shown)
Mode	D		N = No position fix A = Autonomous GNSS fix D = Differential GNSS fix R = RTK fixed F = RTK float E = Estimated/Dead reckoning fix
Navigational status indicator	V		S = Safe C = Caution U = Unsafe V = Void (NMEA Ver 4.10 support only)

Checksum	*39		
<CR> <LF>			End of message termination

● **VTG---Course Over Ground and Ground Speed**

Table 5.1-10 contains the values for the following example:

\$GNVTG,196.90,T,,M,0.01,N,0.01,K,D*21

Table 5.1-10 VTG Data Format

Name	Example	Units	Description
Message ID	\$GNVTG		VTG protocol header
Course over ground	196.90	degrees	Measured heading
Reference	T		True
Course over ground		degrees	Measured heading
Reference	M		Magnetic
Speed over ground	0.01	knots	Measured speed
Units	N		Knots
Speed over ground	0.01	km/hr	Measured speed
Units	K		Kilometer per hour
Mode	D		N = No position fix A = Autonomous GNSS fix D = Differential GNSS fix R = RTK fixed F = RTK float E = Estimated/Dead reckoning fix
Checksum	*21		
<CR> <LF>			End of message termination

5.2 Proprietary NMEA input/output message

Please refer to MTK proprietary message.

5.3 Examples to configure the power mode of GNSS module

The GNSS module supports different power modes that user can configure by issuing software commands.

5.3.1 Standby mode

User can issue software command to make GNSS module go into standby mode that consumes less than 500uA current. GNSS module will be awaked when receiving any byte. The following flow chart is an example to make GNSS module go into standby mode and then wake up.

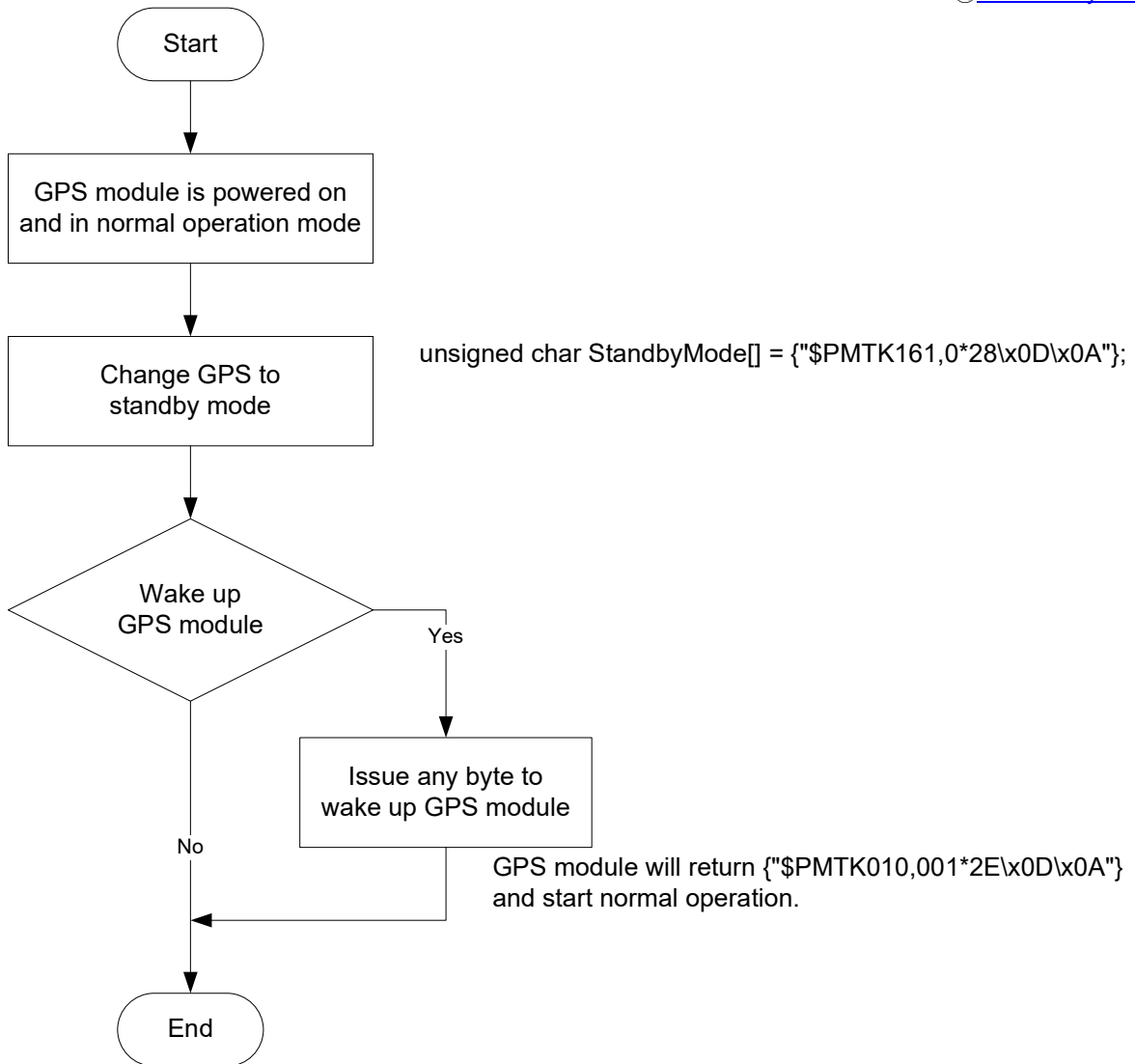

5.3.2 Periodic mode

When GNSS module is commanded to periodic mode, it will be in operation and standby periodically. Its status of power consumption is as below chart.

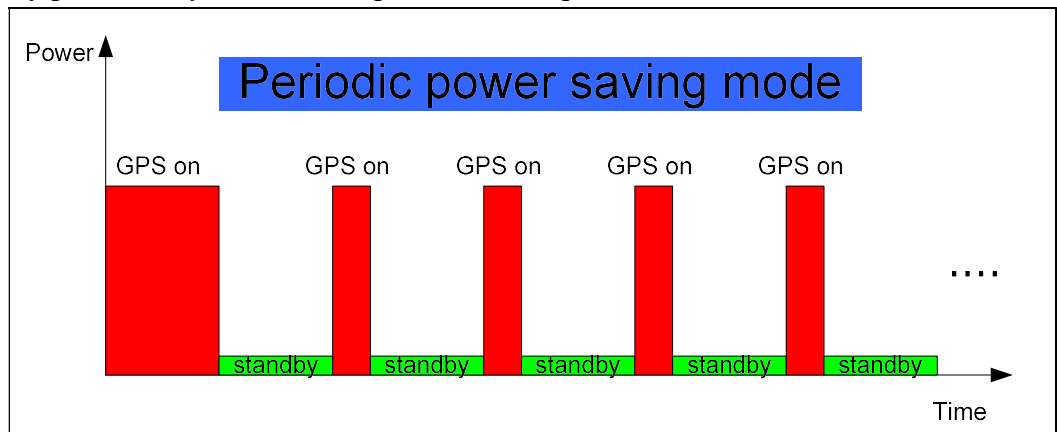

The following flow chart is an example to make GNSS module go into periodic mode and then back to normal operation mode.

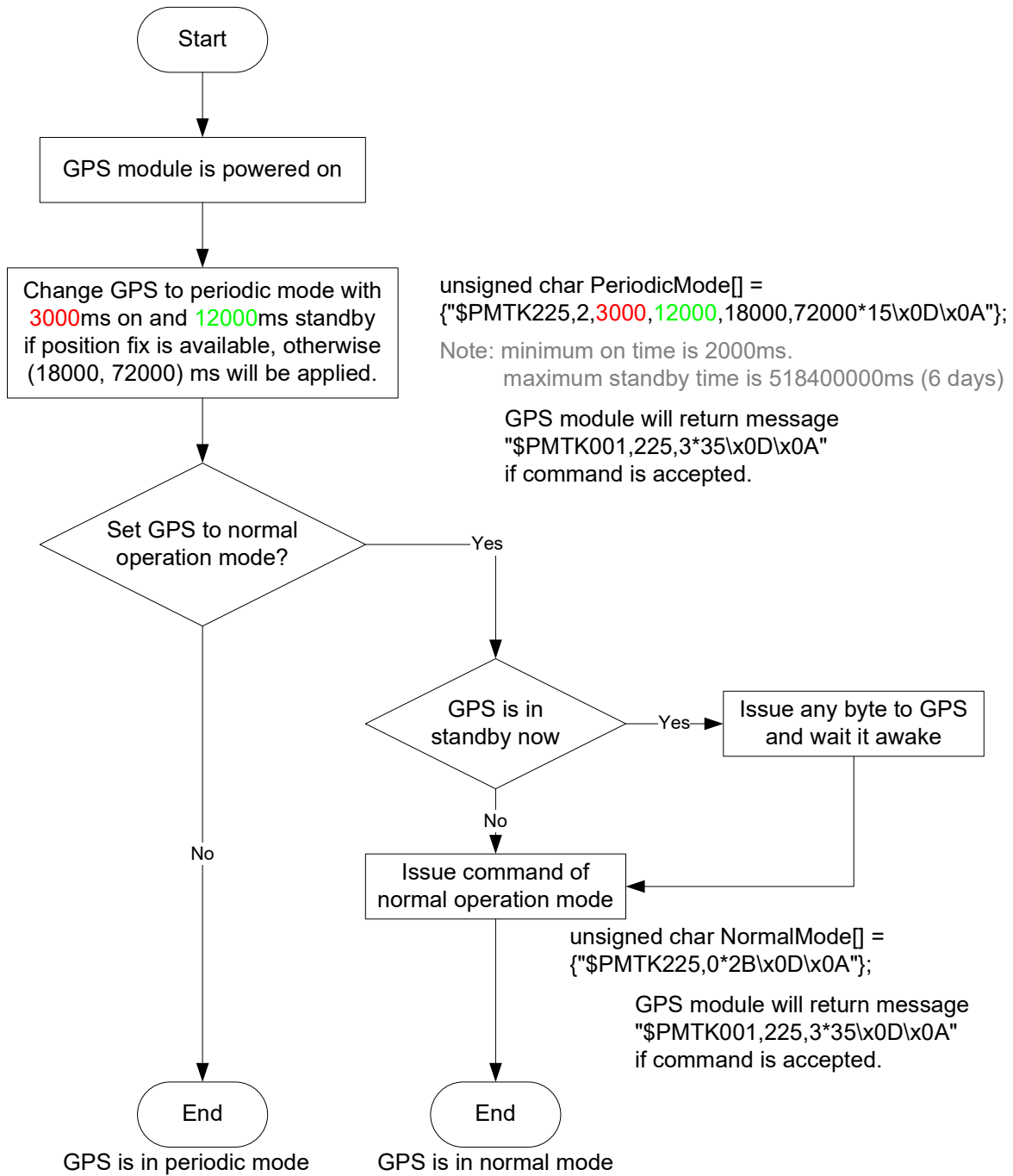

5.3.3 AlwaysLocate™ mode

AlwaysLocate™ is an intelligent controller of periodic mode. Depending on the environment and motion conditions, GNSS module can adaptively adjust working/standby time to achieve balance of positioning accuracy and power consumption. In this mode, the host CPU does not need to control GNSS module until the host CPU needs the GNSS position data. The following flow chart is an example to make GNSS module go into AlwaysLocate™ mode and then back to normal operation mode.

Note: AlwaysLocate™ is a trade mark of MTK.

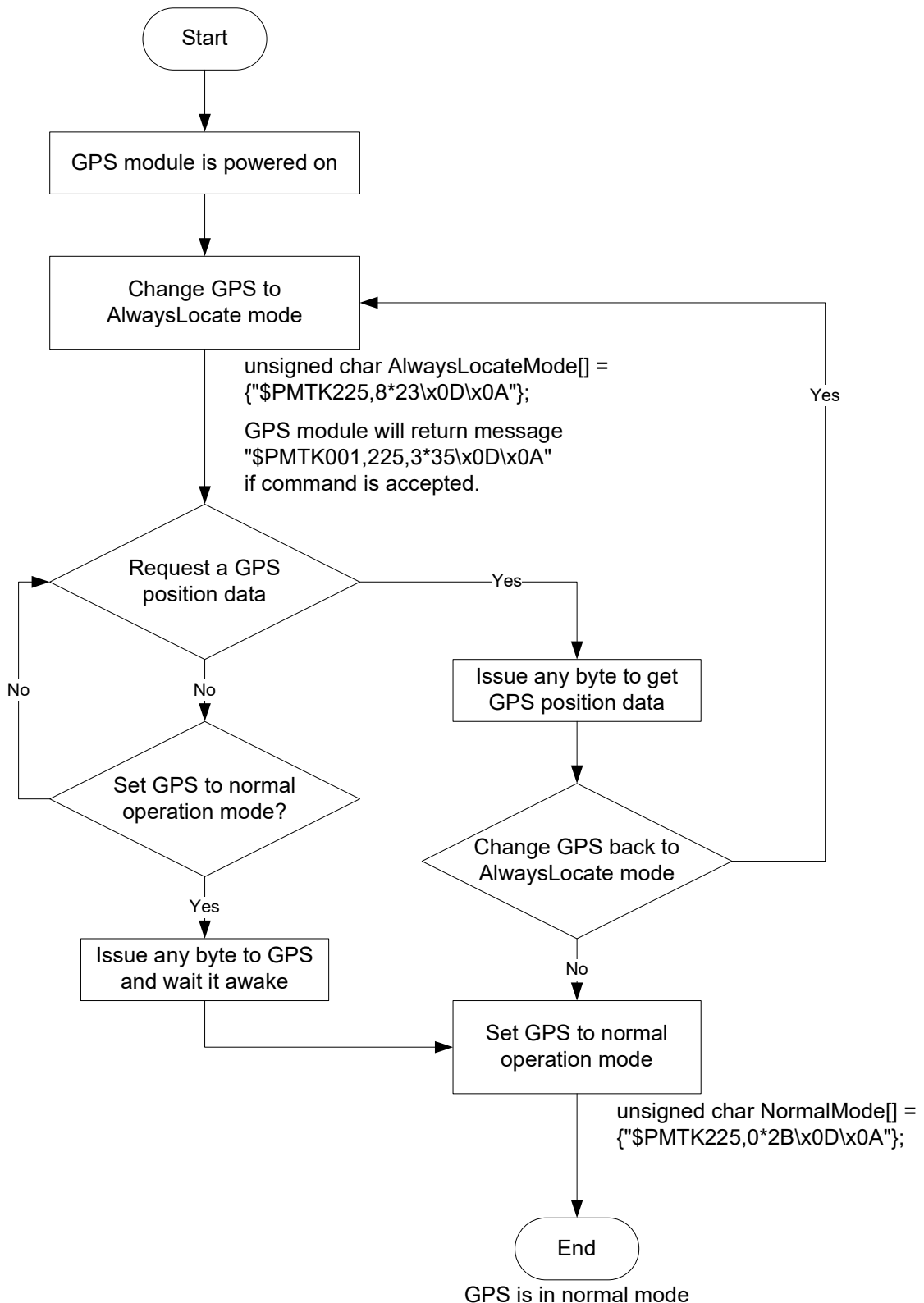

5.4 Data logger

The GNSS module has internal flash memory for logging GNSS data. The configurations include time interval, distance, speed, logging mode, and ... etc. For more information, please

contact us.

5.5 Examples to configure the update rate of GNSS module

The GNSS module supports up to 10Hz update rate that user can configure by issuing software commands. Note that the configurations by software commands are stored in the battery-backed SRAM that is powered through VBACKUP pin. Once it drains out, the default/factory settings will be applied.

Due to the transmitting capacity per second of the current baud rate, GNSS module has to be changed to higher baud rate for high update rate of position fix. The user can use the following software commands to change baud rate.

Baud rate	Software command
Factory default	\$PMTK251,0*28<CR><LF>
4800	\$PMTK251,4800*14<CR><LF>
9600	\$PMTK251,9600*17<CR><LF>
19200	\$PMTK251,19200*22<CR><LF>
38400	\$PMTK251,38400*27<CR><LF>
57600	\$PMTK251,57600*2C<CR><LF>
115200	\$PMTK251,115200*1F<CR><LF>

Note: <CR> means Carriage Return, i.e. 0x0D in hexadecimal. <LF> means Line Feed, i.e. 0x0A in hexadecimal.

If the user does not want to change baud rate, you can reduce the output NMEA sentences by the following software commands.

NMEA sentence	Software command
Factory default	\$PMTK314,-1*04<CR><LF>
Only GLL at 1Hz	\$PMTK314,1,0*29<CR><LF>
Only RMC at 1Hz	\$PMTK314,0,1,0,0,0,0,0,0,0,0,0,0,0,0,0,0,0,0,0,0,0*29<CR><LF>
Only VTG at 1Hz	\$PMTK314,0,0,1,0,0,0,0,0,0,0,0,0,0,0,0,0,0,0,0,0,0*29<CR><LF>
Only GGA at 1Hz	\$PMTK314,0,0,0,1,0,0,0,0,0,0,0,0,0,0,0,0,0,0,0,0,0*29<CR><LF>
Only GSA at 1Hz	\$PMTK314,0,0,0,0,1,0,0,0,0,0,0,0,0,0,0,0,0,0,0,0,0*29<CR><LF>
Only GSV at 1Hz	\$PMTK314,0,0,0,0,0,1,0,0,0,0,0,0,0,0,0,0,0,0,0,0,0*29<CR><LF>
Only ZDA at 1Hz	\$PMTK314,0,1,0*29<CR><LF>
RMC, GGA, GSA at 1Hz and GSV at 0.2Hz	\$PMTK314,0,1,0,1,1,5,0,0,0,0,0,0,0,0,0,0,0,0,0,0,0*2C<CR><LF>
If the command is correct and executed, GNSS module will output message \$PMTK001,314,3*36<CR><LF>	

After the GNSS module is changed to higher baud rate or reduced NMEA sentence, the user can configure it to high update rate of position fix by the following commands.

Interval of position fix	Software command
Every 100ms (10Hz) ⁽¹⁾	\$PMTK220,100*2F<CR><LF>
Every 200ms (5Hz)	\$PMTK220,200*2C<CR><LF>
Every 500ms (2Hz)	\$PMTK220,500*2B<CR><LF>
Every 1000ms (1Hz)	\$PMTK220,1000*1F<CR><LF>
Every 2000ms (0.5Hz) ⁽²⁾	\$PMTK220,2000*1C<CR><LF>
If the command is correct and executed, GNSS module will output message \$PMTK001,220,3*30<CR><LF>	

Note 1: The minimum interval of position fix is 100ms, i.e. the maximum update rate is 10Hz.

Note 2: The current consumption is the same with the update rate of 1Hz.

5.6 Configure the static navigation parameter

The output position of GNSS module will keep the same and output speed will be zero if the actual speed is below the threshold of the static navigation parameter. This is useful for different applications. For example, the car stopped at a red light will get stationary GNSS position if the threshold is 1.5m/s. It is better to disable this function by setting threshold to 0 for pedestrian navigation.

The format of the software command is as below.

```
$PMTK386,speed threshold*checksum<CR><LF>
```

The unit of speed threshold is meter per second. The range of speed threshold is from 0.1m/s to 2.0m/s. Value 0 is to disable the function.

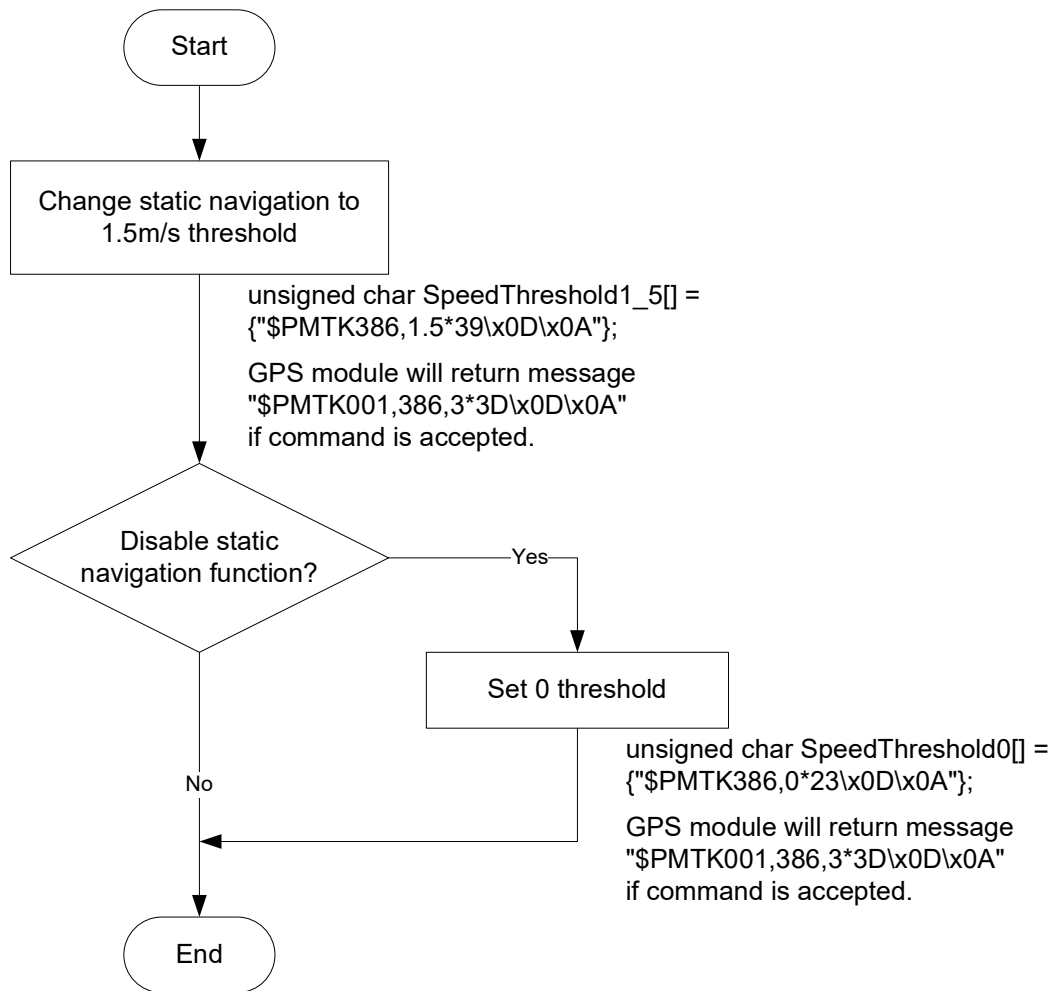

6 Pin assignment and descriptions

Table 6-1 Pin descriptions of PCIe Mini card

Pin #	Name	Type	Description	Note
1	NC			
2	NC			
3	NC			
4	GND	P	Ground	
5	NC			
6	NC			
7	NC			
8	NC			
9	GND	P	Ground	
10	NC			
11	NC			
12	NC			
13	NC			
14	NC			
15	GND	P	Ground	
16	NC			
17	NC			
18	GND	P	Ground	
19	NC			
20	/W_DISABLE	I	Power control input pin. Internal pull-up resistor. High: power on; Low: power off	
21	GND	P	Ground	
22	NC			
23	NC			
24	NC			
25	NC			
26	GND	P	Ground	
27	GND	P	Ground	
28	NC			
29	GND	P	Ground	
30	NC			
31	NC			
32	NC			

33	NC			
34	GND	P	Ground	
35	GND	P	Ground	
36	USB_D-		USB D- line	
37	GND	P	Ground	
38	USB_D+		USB D+ line	
39	NC			
40	GND	P	Ground	
41	NC			
42	NC			
43	GND	P	Ground	
44	NC			
45	NC			
46	NC			
47	NC			
48	NC			
49	TIMEMARK	O	Time pulse (1PPS, default 100 ms pulse/sec when 3D position fix is available)	
50	GND	P	Ground	
51	NC			
52	VCC	P	Power input	

7 DC & Temperature characteristics

7.1 DC Electrical characteristics

Parameter	Symbol	Conditions	Min.	Typ.	Max.	Units	
Input Voltage	VCC		3.0		3.6	V	
Supply Current	I _{ss}	VCC = 3.3V, Peak		51	165	mA	
		Acquisition		40 ⁽¹⁾		mA	
		Tracking			17		mA
		Standby					mA
		Power off			<1 ⁽²⁾		uA
High Level Input Voltage	V _{IH}	/W_DISABLE pin	1.3		VCC	V	
Low Level Input Voltage	V _{IL}	/W_DISABLE pin			0.25	V	
High Level Input Current	I _{IH}	/W_DISABLE pin	-5		1	uA	
Low Level Input Current	I _{IL}	/W_DISABLE pin	-5		1	uA	

Note (1): Measured when position fix (1Hz) is available, input voltage is 3.3V and the function of self-generated ephemeris prediction is inactive.

Note (2): Measured when /W_DISABLE pin is at low level.

7.2 Temperature characteristics

Parameter	Symbol	Min.	Typ.	Max.	Units
Operating Temperature	T _{opr}	-40	-	85	°C
Storage Temperature	T _{stg}	-40	25	85	°C

Note: The operating and storage temperature of the built-in micro battery are -20 ~ +60 °C and -40 ~ +60 °C respectively. GNSS module will still work even the battery is broken or short due to temperature or other issues.

8 Mechanical specification

The dimension and pin definition are compliant with PCI Express Mini Card Revision 1.2.

8.1 Outline dimensions of LS26030-B

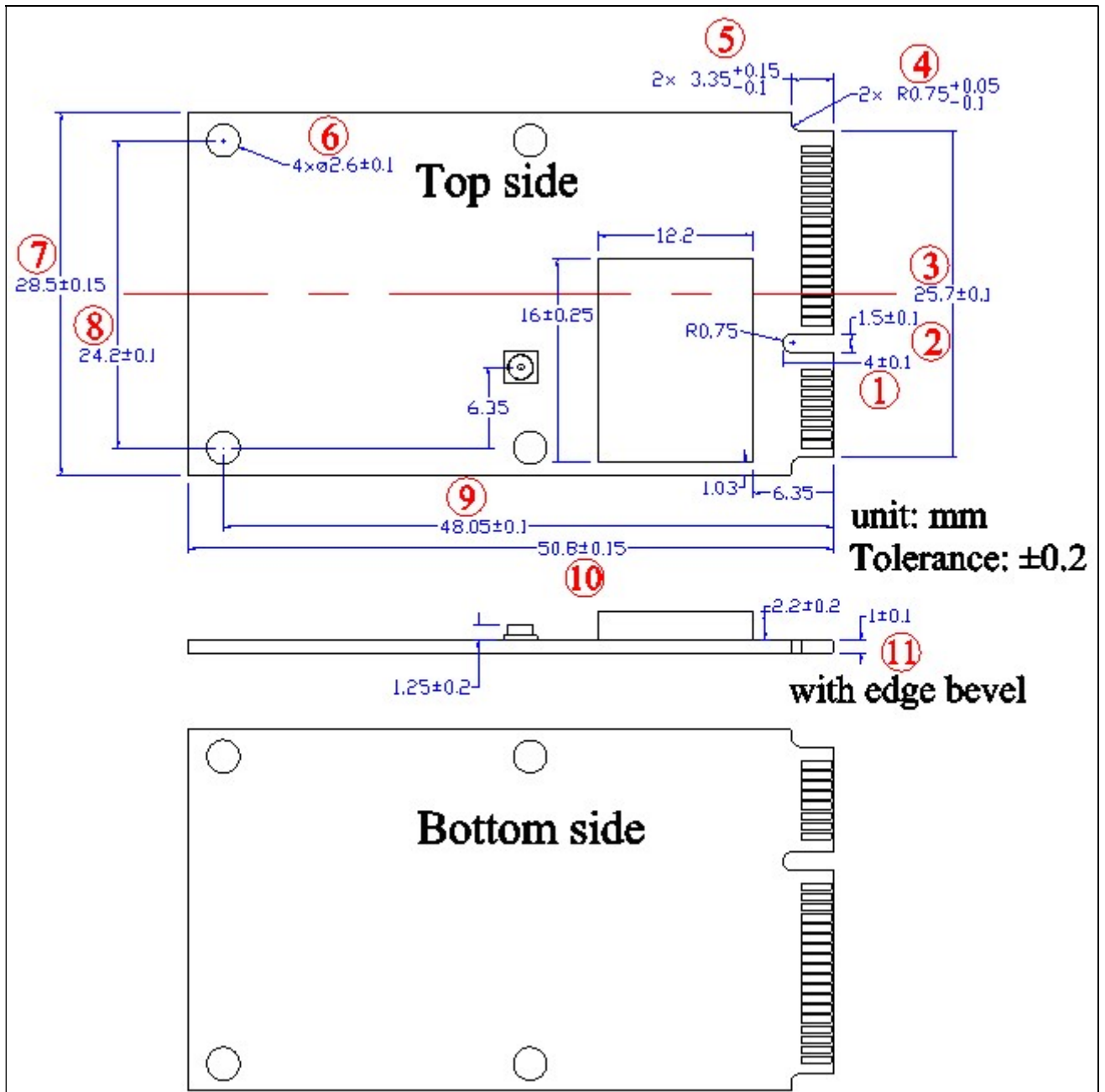

8.2 Outline dimensions of LS26031-B

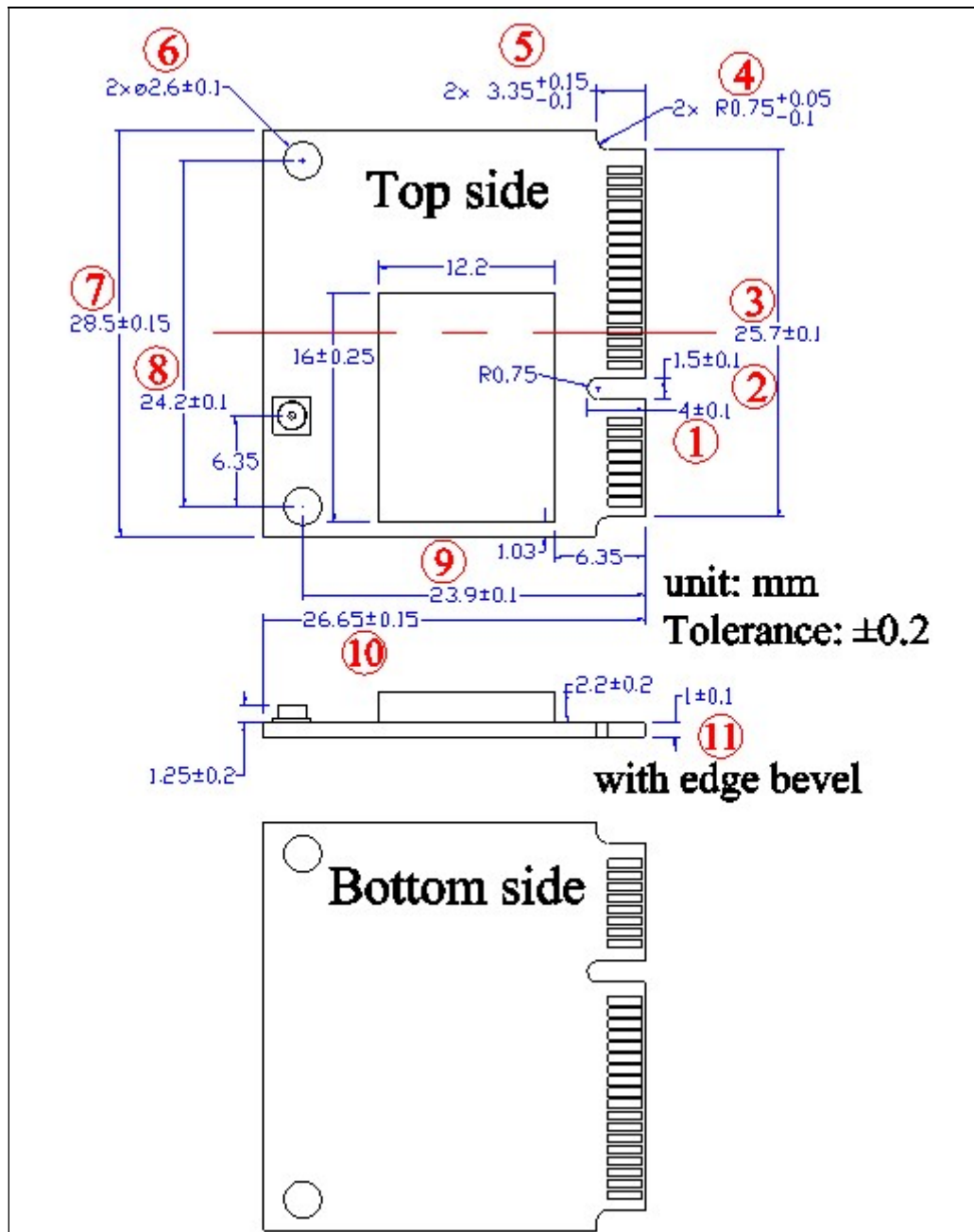

9 Packing information

Both LS26030-B and LS26031-B use the same package.



1pcs in an antistatic bag

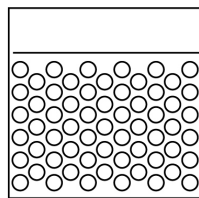

6pcs in a bubble bag

30 bubble bags in a carton
(180pcs)

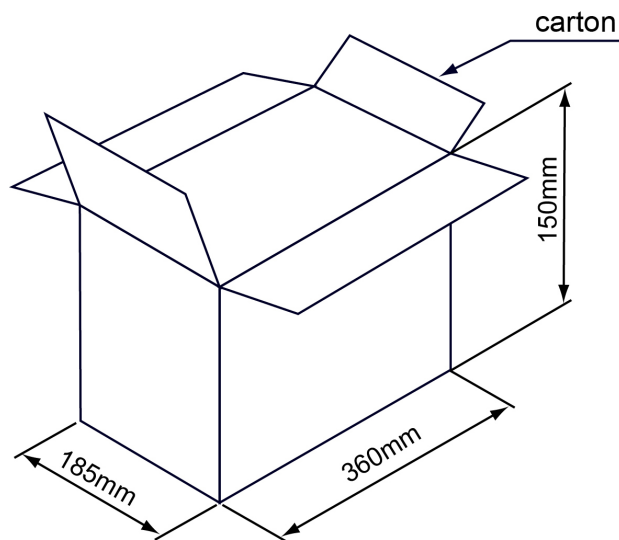

Tolerance: ± 10 mm

Document change list

Revision 1.0

- First release on Oct. 16th, 2013.

Revision 1.1 (July 24, 2020)

- Revised protocol support NMEA 0183 version from 4.10 to 4.00 in the section 4.
- Added “Note 1” in the section 4.
- Revised section 5.1 NMEA output message.

Revision 1.2 (December 22, 2021)

- Changed the packaging in section 9.