

REVISIONS					
REV	ECO	DESCRIPTION	DATE	BY	APPR
A1	--	RELEASED DRAWING	AUG-10-16	JARRY	TOMMY
A2	--	UPDATE NOTES	Jun-22-2017	Nick	TOMMY
A3	--	UPDATE CABLE OD RANGE	Aug-24-2017	Nick	TOMMY

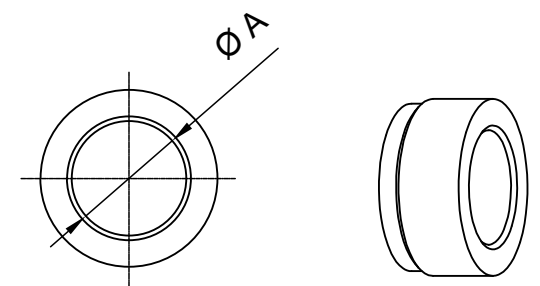
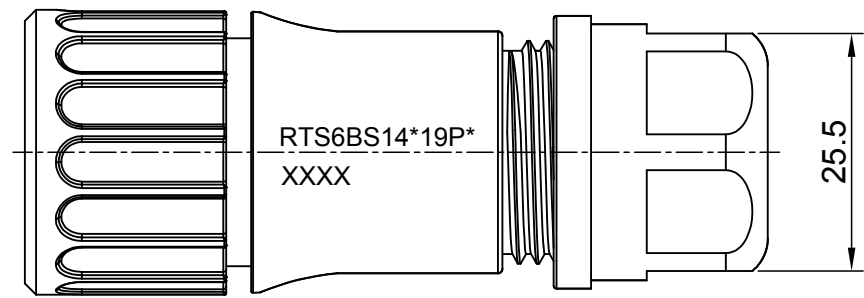
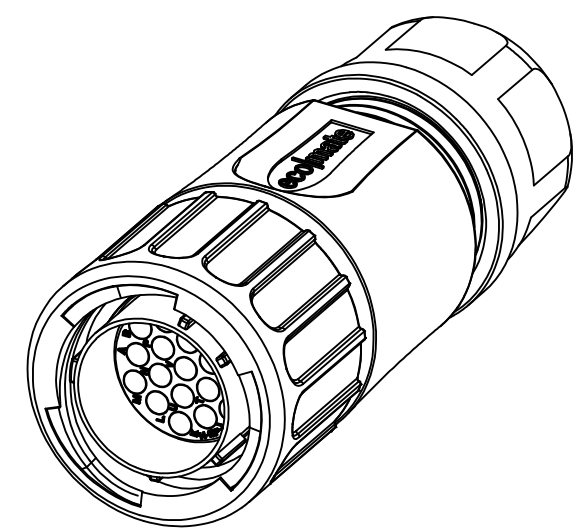
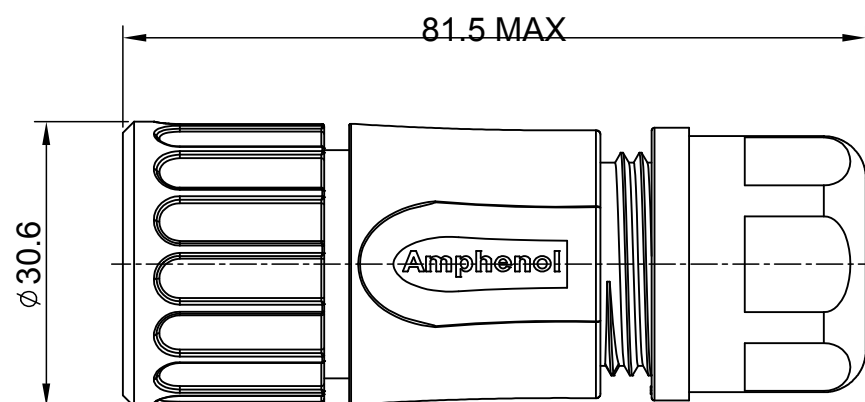
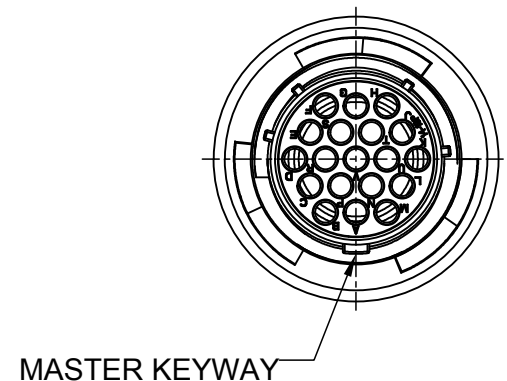

NOTES : (UNLESS OTHERWISE SPECIFIED)

- MATERIAL :
 SHELL : THERMOPLASTIC , UL94 V-0.
 INSERT : THERMOPLASTIC , UL94 V-0.
 COUPLING NUT : THERMOPLASTIC , UL94 V-0.
 O-RING : NBR OR SILICONE RUBBER.
 WASHER : SILICONE RUBBER.
 BACK SHELL : THERMOPLASTIC , UL94 V-0.
 CLAMP NUT : THERMOPLASTIC , UL94 V-0.
 CLAMP RING : THERMOPLASTIC , UL94 V-0.
 CABLE SEAL : EPDM.
- SPECIFICATIONS :
 2.1 RATED CURRENT : 5A (MAX).
 2.2 RATED VOLTAGE : 250V(AC/DC).
 2.3 OPERATING TEMPERATURE : SEE TABLE.
 2.4 DIELECTRIC WITHSTANDING VOLTAGE : LESS THAN 2 MILLIAMPS CURRENT LEAKAGE@2000 VOLTS AC. 2.5 INSULATION RESISTANCE : 5000 MEGOHMS MIN. 2.6 IP CLASS : IP67 AND IP69K.
 2.7 MATING CYCLES DURABILITY : 500 CYCLES MIN. 2.8 RoHS COMPLIANT.
- SUITABLE CONTACTS : 20# CONTACT.
- ALL DIMENSIONS ARE FOR REFERENCE USE ONLY.

DIMENSION ØA	CABLE OD RANGE
12.3MM	7.0-12.0MM
14.3MM	9.0-14.0MM

KEY	PART NUMBER	
		-40°C ~ +105°C
N	RTS6BS14N19P	RTS6BS14N19P03

QUANTITY	PART NUMBER	DESCRIPTION	ITEM								
MATERIALS LIST											
UNLESS OTHERWISE SPECIFIED		Amphenol									
1) All dimensions are in metric (mm).		Sine Systems - www.amphenol-sine.com									
2) PL DEC ±0.15 Angles ±1°		44724 Morley Drive									
3) Note reference = X		Clinton Township, MI 48036									
MATERIAL SPECIFICATIONS:		ECO-MATE, PLUG, BACK SHELL, SIZE 14, 19POS, PIN									
PROCESS SPECIFICATIONS:		THIS DRAWING IS SUPPLIED FOR INFORMATION ONLY. DESIGN FEATURES, SPECIFICATIONS AND PERFORMANCE DATA SHOWN HEREON ARE THE PROPERTY OF THE AMPHENOL CORPORATION. NO RIGHTS OF REPRODUCTION ARE IMPLIED. ALL DIMENSIONS ARE SUBJECT TO NORMAL MANUFACTURING VARIATIONS.									
NEXT ASSY:		<table border="1"> <tr> <td>SIZE</td> <td>TYPE</td> <td>DWG NO:</td> <td>REVISION</td> </tr> <tr> <td>B</td> <td>C-</td> <td>RTS6BS14*19P*</td> <td>A3</td> </tr> </table>		SIZE	TYPE	DWG NO:	REVISION	B	C-	RTS6BS14*19P*	A3
SIZE	TYPE	DWG NO:	REVISION								
B	C-	RTS6BS14*19P*	A3								
SCALE: NONE		SHEET 1 OF 1									

TITLE: ECO-MATE PLUG, BACK SHELL, SIZE 14, 19POS, PIN
 DWG NO: RTS6BS14*19P*
 REV: A3
 SH: 1
 OF: 1