

# SOLAR PRODUCTS





# HeliosFuse

Amphenol Technical Products International (ATPI) offers products and solutions for all segments of the solar electric system. ATPI understands the need for efficient (low loss) power transfer, highly reliable, and cost effective solutions that are required to be competitive in this industry. We can provide panel manufactures, installer, and OEM's with connectivity products for both thin film and crystalline silicon technologies.

ATPI's molded in-line fuse, HeliosFuse, provides a quick solution for installing in-line solar fuses. The molded construction provides weather tight housing preventing moisture from getting to the fuse construction. The in-line fuse provides the needed electrical protection to prevent damage to the solar array should a ground fault occur. HeliosFuse is currently offered in our custom wire harnesses.

Amphenol Technical Products International can help you power the planet with the sun. The HeliosFuse is just one of the solar solutions Amphenol Technical Products International has to offer.

# HeliosFuse

## Features

- 1A to 30A current rating
- 1500V (1000V compatible)
- IP68 protection degree
- Meets UL94-0V0 flammability rating
- UL4248-1 & UL4248-19 recognized
- UL9703 listed
- RETIE compliance



# 1500V HeliosFuse

## Specifications

Description	1500V HeliosFuse
Rated Voltage Fuse	1500V
Rated Current Fuse	2.5A, 3.5A, 4A, 6A, 8A, 10A, 12A, 15A, 20A, 25A, 30A
Connector Options	UL Listed Connectors: H4, H4 Plus, MC4, EVO2, PV4-S1
Cable Size Options	12AWG or 10AWG or 8AWG 2kV PV Wire
Ingress Protection Degree	IP68 (1 Meter, 1 Hour)
Ambient Temperature Range	-40°C to 50°C
Material Safety	RoHS2 Compliant
Flammability Classifications	UL94-V0
Outdoor Suitability	UV Resistance, F1 Rated
Approvals	UL4248-1; UL4248-18 Recognized (File#: E352863) UL9703 Listed (File#: E498904)

### 1500V 2.5A-4A FUSE

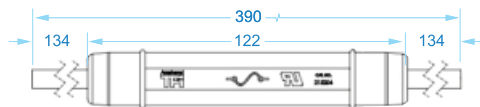

1500V FUSE/4A/12AWG/BLUNT CUT  
END TO END CABLE LENGTH 390MM  
(PART NUMBER: **2421000**)

### 1500V 5A-15A FUSE

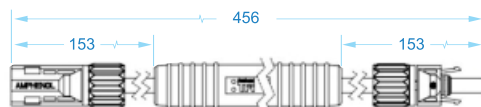

1500V FUSE/15A/10AWG/H4 M-F  
END TO END CABLE LENGTH 390MM  
(456MM REF OVERALL W/CONNECTORS)  
(PART NUMBER: **2470020**)

### 1500V 20A FUSE

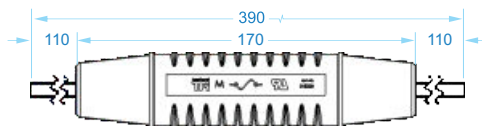

1500V FUSE/20A/10AWG/BLUNT CUT  
END TO END CABLE LENGTH 390MM  
(PART NUMBER: **2480000**)

### 1500V 25A-30A FUSE

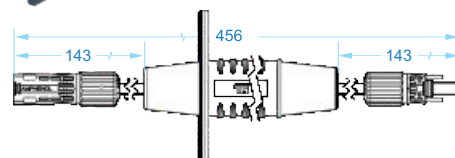

1500V FUSE/30A/10AWG/H4 PLUS M-F  
END TO END CABLE LENGTH 390MM  
FUSE SPACER INCLUDED  
(456MM REF OVERALL W/CONNECTORS)  
(PART NUMBER: **24A0050**)

## Ordering Information

PRODUCT TYPE		RATED CURRENT		PV WIRE SIZE		END TERMINATION / CONNECTORS		END TO ENDCABLE LENGTH		CUSTOM LENGTH
24	1500V HeliosFuse	0	2.5 A	0	10AWG	00	BLUNT CUT BOTH ENDS	0	STANDARD (390 MM)	
		1	3.5 A			01	BOTH END PRESTRIPPED (8MM, SLUGS ON)			
		2	4 A			02	AMPHENOL H4 MALE TO H4 FEMALE (M-F)			
		3	6 A	1	12AWG	03	MULTI CONTACT MC4 MALE TO FEMALE (M-F)	1	CUSTOM	
		4	8 A			04	MULTI CONTACT EVO2 MALE TO FEMALE			
		5	10 A			05	AMPHENOL H4 PLUS MALE TO FEMALE (M-F)			
		6	12 A	2	8AWG	06	TYCO ELECTRONIC PV4-S1 MALE TO FEMALE (M-F) (12AWG/10AWG)	1	CUSTOM	
		7	15 A			07	OTHER CONNECTORS			
		8	20 A							
		9	25 A							
		A	30 A							

## OVERMOLDED SOLAR JUNCTIONS

Amphenol Technical Products International (ATPI) offers products and solutions for all segments of the solar electric system. ATPI understands the need for efficient (low loss) power transfer, highly reliable, and cost effective solutions that are required to be competitive in this industry.

ATPI's overmolded solar junctions provides the ideal low cost, high quality solution for commercial photovoltaic installations. The molded construction provides weather tight housing preventing moisture from getting to the cable joints and provides the needed electrical protection with a rugged design. They can be pre-fabricated with various lengths, number of branches, distance between branches and cable options according to customer specifications.

Amphenol Technical Products International maintains the highest standards for excellence. The 1500V overmolded solar junctions is just one of the cost effective solar solutions Amphenol Technical Products International has to offer.



## Features

- 1500V DC Current Rating
- 4AWG, 6AWG, 8AWG, 10AWG, 12AWG, 14AWG cable options for 1500V
- IP68 ingress protection
- Long term UV resistance
- Ready for field assembly
- UL9703 listed & UL6703 approved
- Customer wiring harness services
- RETIE compliance

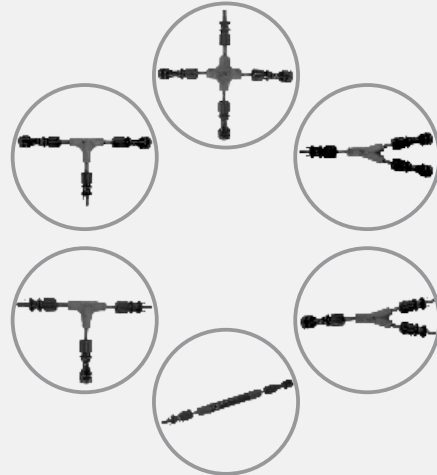

## Specification

DC Current Rating	1500V (600V & 1000V Compatible)
Junction Current Rating	65A
Connector Options	H4/MC4/EVO2/H4 PLUS/PV4-S1
Cable Size Options	4AWG, 6AWG, 8AWG, 10AWG, 12AWG
Ingress Protection Degree	IP68 (1m Water/24hours)
Ambient Temperature Range	-40°C to 50°C
Material Safety	RoHS2 Compliant
Flammability Classifications	UL94-V0
Outdoor Suitability	UV Resistance, F1 Rated
Approvals	UL6703; UL4248-1; UL4248-18 Recognized UL9703 Listed

### 1500V Solar Junction

X Junction PN: **2211415**

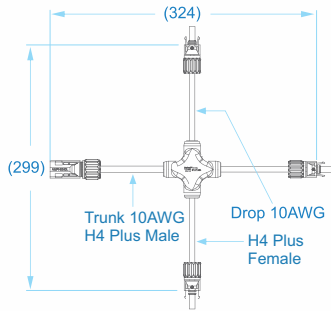
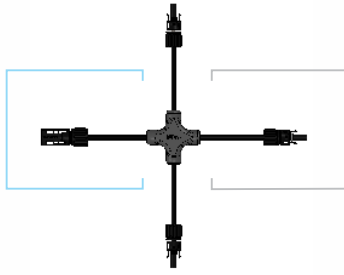

Y Junction PN: **2200900**

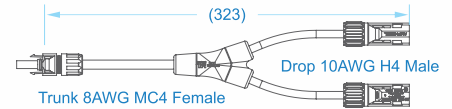
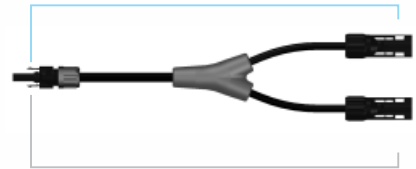

Y Junction PN: **2200815**

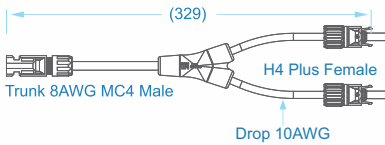
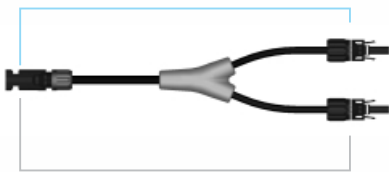

T1-Top Junction PN: **2221615**

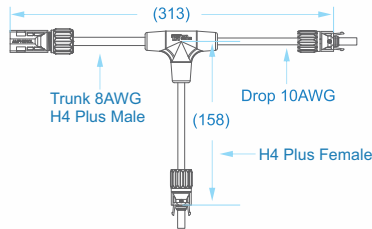

T2-Bottom Junction PN: **2230803**

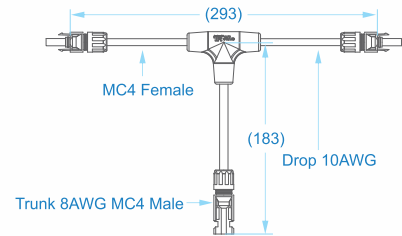
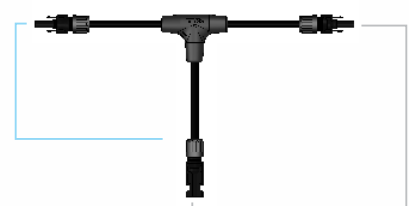

### Ordering Information

22 0 01 03

STANDARD PRODUCT		TYPE	TRUNK SIDE		DROP SIDE		
22	1500V OVERMOLD JUNCTION	0	Y	00	10AWG H4 MALE	00	10AWG H4 MALE
				01	10AWG H4 FEMALE	01	10AWG H4 FEMALE
				02	10AWG MC4 MALE	02	10AWG MC4 MALE
				03	10AWG MC4 FEMALE	03	10AWG MC4 FEMALE
				04	10AWG EVO2 MALE	04	10AWG EVO2 MALE
		1	X	05	10AWG EVO2 FEMALE	05	10AWG EVO2 FEMALE
				06	8AWG H4 MALE	06	8AWG H4 MALE
				07	8AWG H4 FEMALE	07	8AWG H4 FEMALE
				08	8AWG MC4 MALE	08	8AWG MC4 MALE
				09	8AWG MC4 FEMALE	09	8AWG MC4 FEMALE
		2	T1-TOP	10	8AWG EVO2 MALE	10	8AWG EVO2 MALE
				11	8AWG EVO2 FEMALE	11	8AWG EVO2 FEMALE
				12	10AWG BLUNT CUT	12	10AWG BLUNT CUT
				13	8AWG BLUNT CUT	13	8AWG BLUNT CUT
				14	10AWG H4 PLUS MALE	14	10AWG H4 PLUS MALE
				15	10AWG H4 PLUS FEMALE	15	10AWG H4 PLUS FEMALE
		3	T2-BOT	16	8AWG H4 PLUS MALE	16	8AWG H4 PLUS MALE
				17	8AWG H4 PLUS FEMALE	17	8AWG H4 PLUS FEMALE
				18	10AWG PV4-S1 MALE	18	10AWG PV4-S1 MALE
				19	10AWG PV4-S1 FEMALE	19	10AWG PV4-S1 FEMALE
20	OTHER CONNECTORS			20	OTHER CONNECTORS		



### 1500V Solar Junction

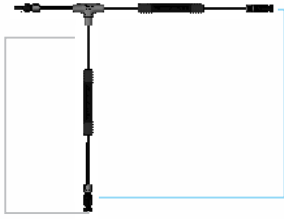

T1-Top Junction with Fuses  
PN: **29209023**

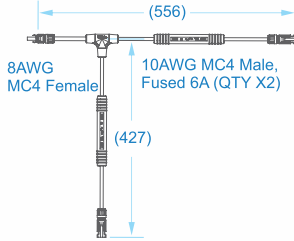

T2-Bottom Junction with Fuses  
PN: **29316087**

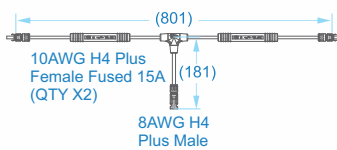

Y Junction with Fuses  
PN: **29017072**

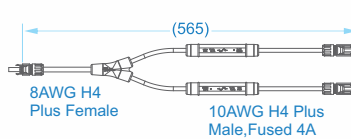

X Junction with Fuses  
PN: **29109022**

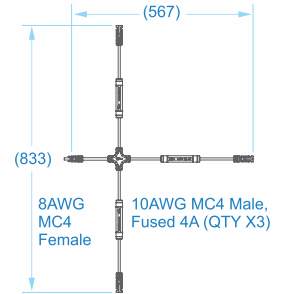

T1-Top Junction No Fuses  
PN: **2920803X**

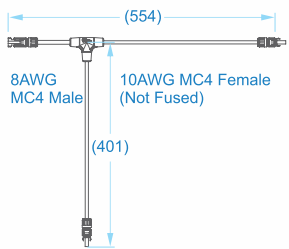

T2-Bottom Junction No Fuses  
PN: **2930902X**

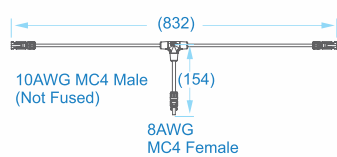

Y Junction No Fuses  
PN: **2901608X**

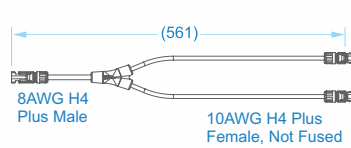

X Junction No Fuses  
PN: **2910803X**

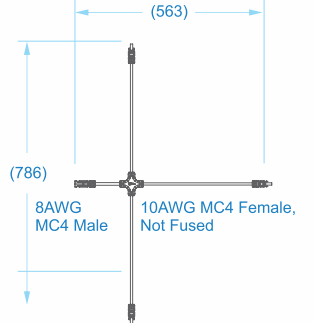

### Ordering Information

29 0 01 01 3

STANDARD PRODUCT	TYPE	TRUNK SIDE		DROP SIDE		DROP WITH FUSES			
29	0	Y	00	10AWG H4 MALE	00	10AWG H4 MALE	0	FUSED (2.5A)	
			01	10AWG H4 FEMALE	01	10AWG H4 FEMALE	1	FUSED (3.5A)	
			02	10AWG MC4 MALE	02	10AWG MC4 MALE	2	FUSED (4A)	
			03	10AWG MC4 FEMALE	03	10AWG MC4 FEMALE	3	FUSED (6A)	
			04	10AWG EVO2 MALE	04	10AWG EVO2 MALE	4	FUSED (8A)	
		1	X	05	10AWG EVO2 FEMALE	05	10AWG EVO2 FEMALE	5	FUSED (10A)
				06	8AWG H4 MALE	06	10AWG BLUNT CUT	6	FUSED (12A)
				07	8AWG H4 FEMALE	07	10AWG H4 PLUS MALE	7	FUSED (15A)
				08	8AWG MC4 MALE	08	10AWG H4 PLUS FEMALE	8	FUSED (20A)
				09	8AWG MC4 FEMALE	09	10AWG PV4-S1 MALE	9	FUSED (25A)
	2	T1-TOP	10	8AWG EVO2 MALE	10	10AWG PV4-S1 FEMALE	A	FUSED (30A)	
			11	8AWG EVO2 FEMALE	11	OTHER CONNECTORS	X	NO FUSE	
			12	10AWG BLUNT CUT					
			13	8AWG BLUNT CUT					
			14	10AWG H4 PLUS MALE					
	3	T2-BOT	15	10AWG H4 PLUS FEMALE					
			16	8AWG H4 PLUS MALE					
			17	8AWG H4 PLUS FEMALE					
			18	10AWG PV4-S1 MALE					
			19	10AWG PV4-S1 FEMALE					
20			OTHER CONNECTORS						

## BALANCE OF SYSTEM (BOS) SOLUTION FOR PV WIRING HARNESSSES

Solar projects require custom wire harness solutions. Amphenol TPI developed and certified a configurable product line to fit your project requirements and specifications.

### Certifications

- UL9703 Listed Product
- UL4703 PV Wire
- UL4248 Overmolded Fuse
- UL6703 Connectors

### Quality Inspection

- 100% Electrically Tested Point to Point
- Ensuring Each Harness is Defect Free
- Visual Inspection, Continuity Test, Resistance Check, Water Leakage test

### APPLICATION EXAMPLE

#### Cable Harness Assemblies for Solar Panels

##### POSITIVE 3 STRING HARNESS

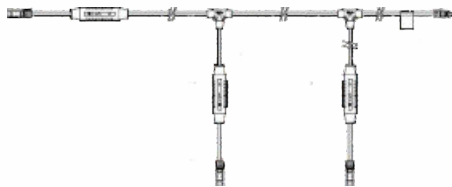

##### NEGATIVE 3 STRING HARNESS



##### SERIES 4: 8 STRING HARNESSSES

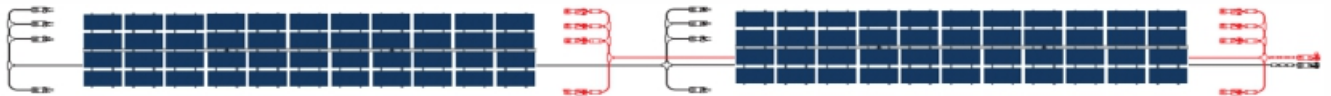

##### SERIES 6: 6 STRING HARNESSSES



##### POSITIVE 13 STRING HARNESS

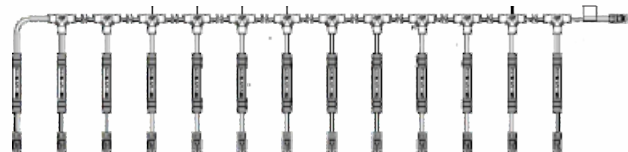

##### NEGATIVE 13 STRING HARNESS

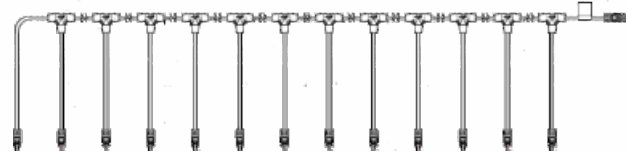

### CUSTOM HARNESSSES

For custom solar wire harnesses for your project requirements, please contact ATPI's solar products team by referring to the contact Information section below.

#### CONTACT INFORMATION:

For further information on your individual application requirements or inquiries, please contact ATPI's solar products team:

#### North America

Winnipeg, Manitoba, Canada  
Telephone +1 204 697-2222  
Address: 2110 Notre Dame Avenue

Email [solar@tpil.com](mailto:solar@tpil.com)  
Websites [www.amphenol-industrial.com](http://www.amphenol-industrial.com)  
[www.tpil.com](http://www.tpil.com)  
<https://downloads.tpil.com/> (Contact us for login information)

## PRODUCT GALLERY

1500V OVERMOLDED  
T-JUNCTION

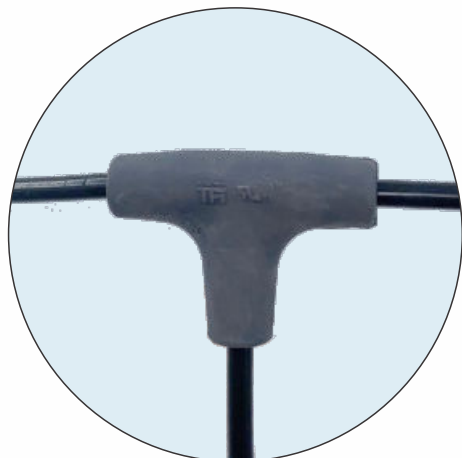

1500V OVERMOLDED  
5A FUSE

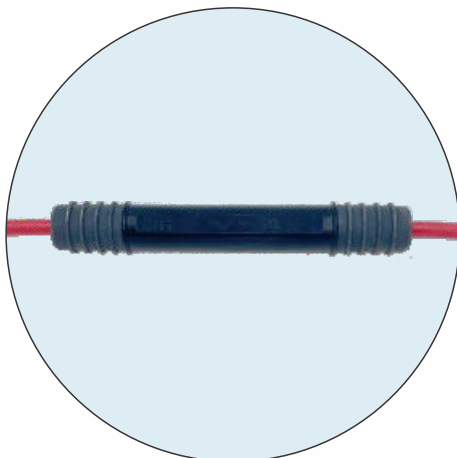

1500V OVERMOLDED  
BIG T-JUNCTION



1500V OVERMOLDED  
Y-JUNCTION

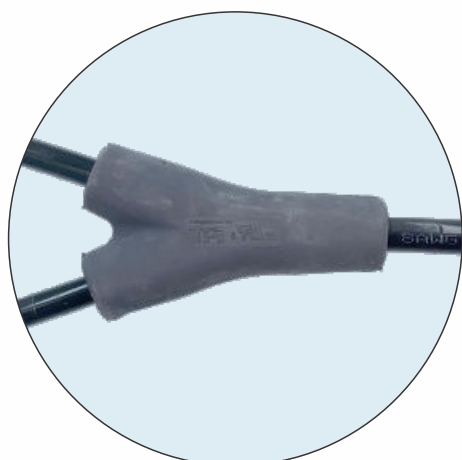

1500V OVERMOLDED  
30A FUSE

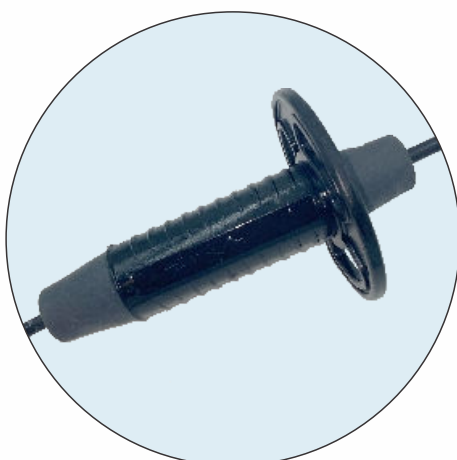

1500V IN-LINE  
OVERMOLD

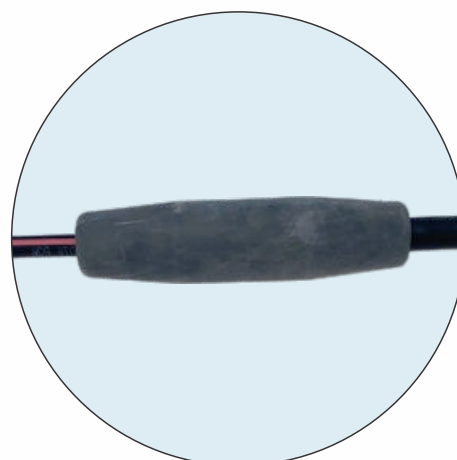

1500V OVERMOLDED  
3:2 STARR JUNCTION

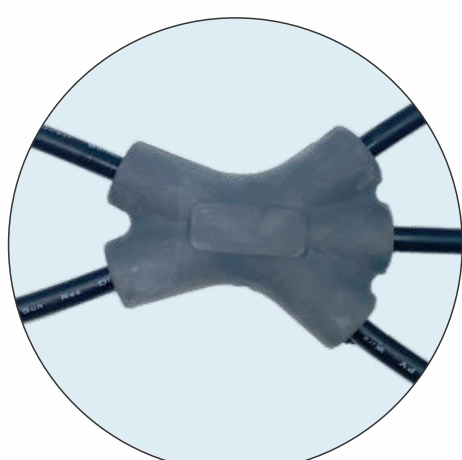

1500V OVERMOLDED  
4A FUSE

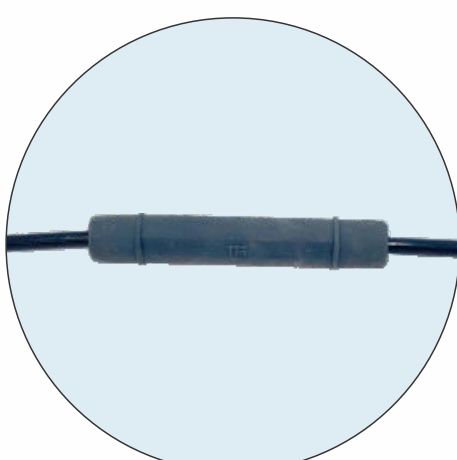

1500V OVERMOLDED  
X-JUNCTION

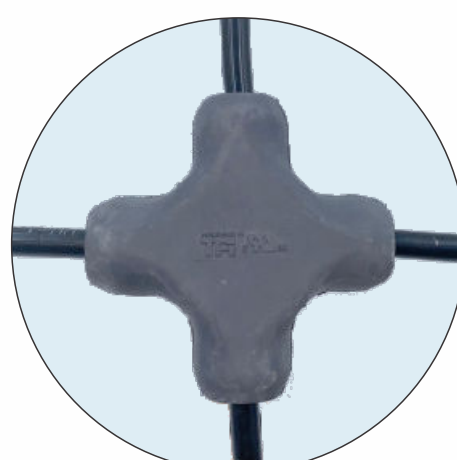

### Amphenol Technical Products International

- Winnipeg, Manitoba, Canada  
Telephone: +1 204 697 2222  
Address: 2110 Notre Dame Avenue  
.....
- Nogales, AZ, USA  
Telephone: +1 520-397-70-00  
Address: 482 Mariposa Road Building A, 85621  
.....
- ChangZhou, China  
Telephone: +86 519 8981 9713  
Address: No.11 Fengxiang Road, New District, Changzhou, Jiangsu,China

