

---

**1 A PWM/VFM Dual Step-down DC/DC Converter with Synchronous Rectifier for Automotive Applications**

---

NO.EC-285-170906

**OUTLINE**

The RP550L001B is a 1 A<sup>(1)</sup> dual step-down DC/DC converter with synchronous rectifier. Replacing diodes with built-in switching transistors improves the efficiency of rectification. Therefore, by simply using two inductors, resistors and capacitors as the external components, a low ripple high efficiency synchronous rectifier step-down DC/DC converter can be easily configured.

Protection functions include a current limit function, a latch-off overcurrent protection function, a thermal shutdown function, and so on.

Output Voltage Control Methods have two operating modes: Forced PWM mode and PWM/VFM Auto-switching mode. By inputting a signal to the MODE pin, the RP550L001B can select from between two modes. When the both converters are in PWM control, the converters operate with 180° turn-on phase shift of the switching transistors.

**FEATURES**

- Input Voltage Range (Maximum Rating)
  - 0.6 V ≤ V<sub>SET</sub><sup>(2)</sup> < 0.8 V ..... 2.3V to 4.5V (6.5V),
  - 0.8 ≤ V<sub>SET</sub> ..... 2.3 V to 5.5 V (6.5 V)
- Operating Temperature Range ..... -40°C to 105°C
- Supply Current ..... Typ. 45 μA (VFM mode at no load per 1 channel)
- Standby Current ..... Typ. 0 μA
- Adjustable Output Voltage Range<sup>(3)</sup> ..... 0.6 V to 3.3 V
- Feedback Voltage Accuracy ..... ±9 mV (V<sub>FB</sub> = 0.6 V)
- Output Voltage Temperature Coefficient ..... ±100 ppm/°C
- Oscillator Frequency ..... Typ. 2.3MHz
- Oscillator Maximum Duty ..... Min. 100%
- Built-in Driver ON Resistance ..... Typ. Pch. 0.25 Ω, Nch. 0.21 Ω (V<sub>IN</sub> = 3.6 V)
- UVLO Detector Threshold ..... Typ. 2.0 V
- Soft Start Time ..... Typ. 0.2 ms
- LX Current Limit Circuit ..... Typ. 1900 mA/ channel
- Latch Type Protection Circuit ..... Typ. 1.5 ms
- Package ..... DFN3030-12 (3.0 mm x 3.0mm)

---

<sup>(1)</sup> This is an approximate value, because output current depends on conditions and external components.

<sup>(2)</sup> V<sub>SET</sub>: Set Output Voltage

<sup>(3)</sup> Output voltage is settable by external resistor. Recommended range is up to 3.3 V.

---

---

**RP550L001B**

---

NO.EC-285-170906

**APPLICATION**

- Power source for car accessories including car audio equipment, car navigation system, and ETC system

**SELECTION GUIDE****Selection Guide**

Product Name	Package	Quantity per Reel	Pb Free	Halogen Free
RP550L001B-TR-#	DFN3030-12	3,000 pcs	Yes	Yes

Set output voltage ( $V_{SET}$ ) is adjustable with external divider resistors.  
The recommended  $V_{SET}$  range is from 0.6 V to 3.3 V.

#: Specify the Automotive Class Code.

	Operating Temperature Range	Guaranteed Specs Temperature Range	Screening	AEC-Q100
A	-40°C to 105°C	25°C	High Temperature	Grade 2

**BLOCK DIAGRAM**

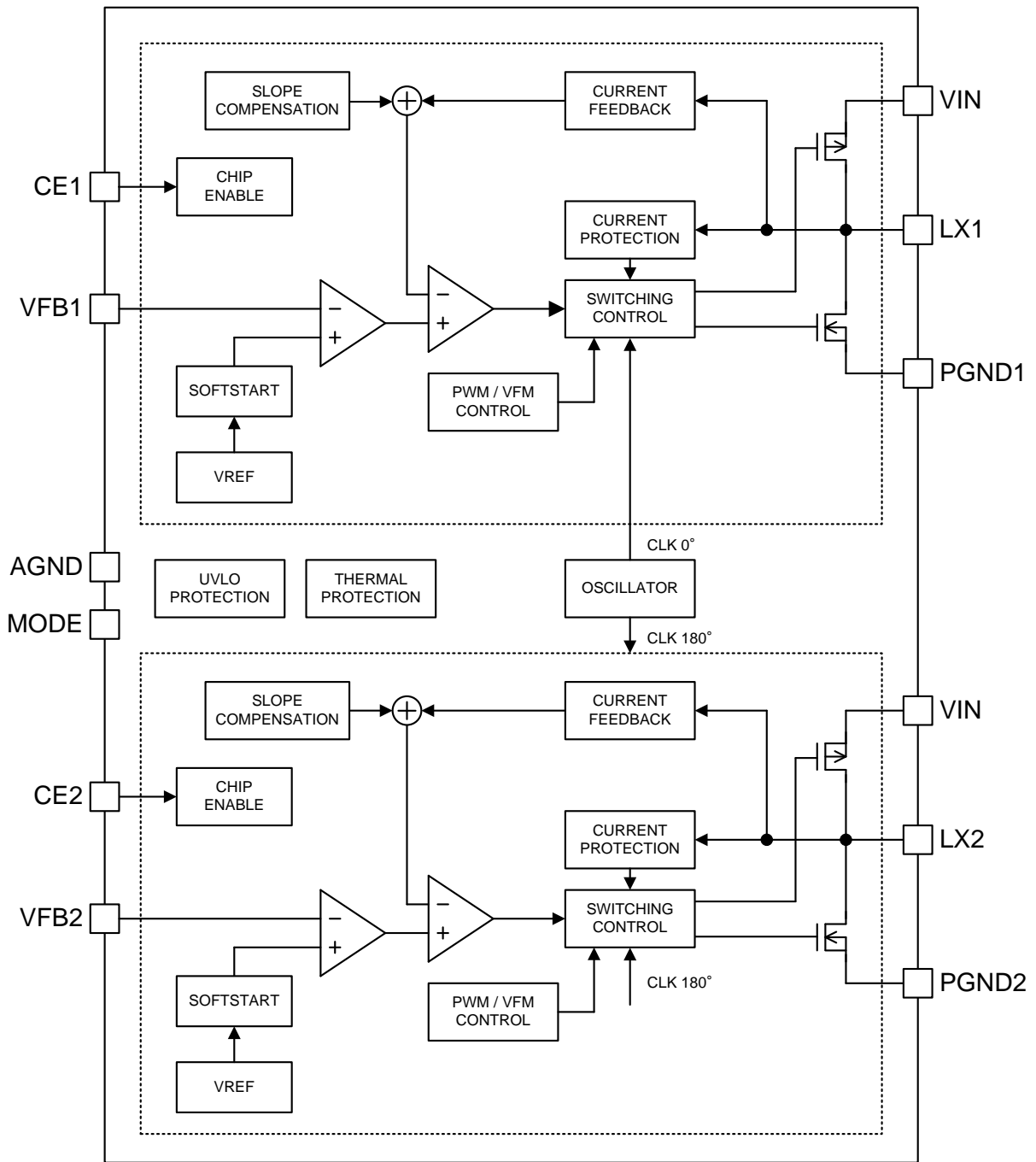

RP550L001B Block Diagram

# RP550L001B

NO.EC-285-170906

## PIN DESCRIPTIONS

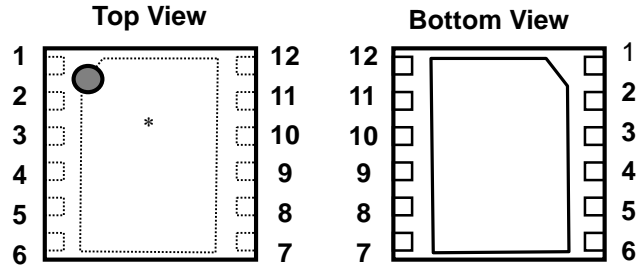

DFN3030-12 Pin Configuration

### Pin Descriptions

Pin No.	Symbol	Description
1	VFB2	Channel 2 Feedback Pin
2	MODE	Mode Control Pin ("H" forced PWM mode, "L" PWM/VFM auto switching mode)
3	VIN <sup>(1)</sup>	Input Pin
4	VIN <sup>(1)</sup>	Input Pin
5	AGND <sup>(2)</sup>	Analog Ground Pin
6	VFB1	Channel 1 Feedback Pin
7	CE1	Channel 1 Chip Enable Pin ("H" active)
8	LX1	Channel 1 LX Switching Pin
9	PGND1 <sup>(2)</sup>	Channel 1 Power Ground Pin
10	PGND2 <sup>(2)</sup>	Channel 2 Power Ground Pin
11	LX2	Channel 2 LX Switching Pin
12	CE2	Channel 2 Chip Enable Pin ("H" active)

\* The exposed tab on the bottom of the package enhances thermal performance and is electrically connected to GND (substrate level). It is recommended that the exposed tab be connected to the ground plane on the board or otherwise be left open.

<sup>(1)</sup> VIN pin (No.3 and No.4) must be wired to the VIN plane when mounting on boards.

<sup>(2)</sup> GND pin (No.5, No.9, and No.10) must be wired to the GND plane when mounting on boards.

## ABSOLUTE MAXIMUM RATINGS

**Absolute Maximum Ratings** (AGND = PGND1 = PGND2 = 0 V)

Symbol	Item		Rating	Unit
$V_{IN}$	VIN Pin Voltage		-0.3 to 6.5	V
$V_{LX1}, V_{LX2}$	LX1 / LX2 Pin Voltage		-0.3 to $V_{IN} + 0.3$	V
$V_{CE1}, V_{CE2}$	CE1 / CE2 Pin Voltage		-0.3 to 6.5	V
$V_{MODE}$	MODE Pin Voltage		-0.3 to 6.5	V
$V_{FB1}, V_{FB2}$	VFB1 / VFB2 Pin Voltage		-0.3 to 6.5	V
$I_{LX1}, I_{LX2}$	LX1 / LX2 Pin Output Current		1.9	A
$P_D$	Power Dissipation <sup>(1)</sup> (DFN3030-12)	Standard Test Land Pattern	1250	mW
		JEDEC STD. 51-7 Test Land Pattern	2440	mW
$T_j$	Junction Temperature Range		-40 to 150	°C
$T_{stg}$	Storage Temperature Range		-55 to 150	°C

### ABSOLUTE MAXIMUM RATINGS

Electronic and mechanical stress momentarily exceeded absolute maximum ratings may cause the permanent damages and may degrade the life time and safety for both device and system using the device in the field. The functional operation at or over these absolute maximum ratings are not assured.

## RECOMMENDED OPERATING CONDITIONS

**Recommended Operating Conditions**

Symbol	Item	Rating	Unit
$V_{IN}$	Input Voltage ( $0.6\text{ V} \leq V_{SET}^{(2)} < 0.8\text{ V}$ )	2.3 to 4.5	V
	Input Voltage ( $0.8 \leq V_{SET}^{(2)}$ )	2.3 to 5.5	V
$T_a$	Operating Temperature Range	-40 to 105	°C

### RECOMMENDED OPERATING CONDITIONS

All of electronic equipment should be designed that the mounted semiconductor devices operate within the recommended operating conditions. The semiconductor devices cannot operate normally over the recommended operating conditions, even if when they are used over such ratings by momentary electronic noise or surge. And the semiconductor devices may receive serious damage when they continue to operate over the recommended operating conditions.

<sup>(1)</sup> Refer to *POWER DISSIPATION* for detailed information.

<sup>(2)</sup>  $V_{SET}$ : Set Output Voltage

## RP550L001B

NO.EC-285-170906

### ELECTRICAL CHARACTERISTICS

Test Circuit is "OPEN LOOP" and Test Condition is AGND=PGND1=PGND2=0V, unless otherwise noted.  
The specifications surrounded by   are guaranteed by design engineering at  $-40^{\circ}\text{C} \leq T_a \leq 105^{\circ}\text{C}$ .

#### RP550L001B (-A) Electrical Characteristics

( $T_a = 25^{\circ}\text{C}$ )

Symbol	Item	Conditions	Min.	Typ.	Max.	Unit
$V_{FB}$	Feedback Voltage	$V_{IN}=V_{CE1}=V_{CE2} = 3.6\text{V}$	$T_a = 25^{\circ}\text{C}$ 0.591	0.600	0.609	V
		$-40^{\circ}\text{C} \leq T_a \leq 105^{\circ}\text{C}$	<span style="border: 1px solid black; padding: 0 2px;">0.588</span>		<span style="border: 1px solid black; padding: 0 2px;">0.612</span>	
$f_{OSC}$	Oscillator Frequency	$V_{IN} = V_{CE1} = V_{CE2} = 3.6\text{V}$	<span style="border: 1px solid black; padding: 0 2px;">2.05</span>	2.30	<span style="border: 1px solid black; padding: 0 2px;">2.55</span>	MHz
$I_{DD1}$	Supply Current 1 <sup>(1)</sup>	$V_{IN} = V_{CE1} = V_{CE2} = 5.5\text{V}$ , $V_{FB1}=V_{FB2} = 0.45\text{V}$ , $V_{MODE} = 0\text{V}$		800	<span style="border: 1px solid black; padding: 0 2px;">1100</span>	$\mu\text{A}$
$I_{DD2}$	Supply Current 2 <sup>(1)</sup>	$V_{IN} = V_{CE1} = V_{CE2} = 5.5\text{V}$ , $V_{FB1}=V_{FB2} = 0.75\text{V}$ , $V_{MODE} = 0\text{V}$		45	<span style="border: 1px solid black; padding: 0 2px;">60</span>	$\mu\text{A}$
$I_{DD3}$	Supply Current 3 <sup>(1)</sup>	$V_{IN} = V_{CE1} = V_{CE2} = 5.5\text{V}$ , $V_{FB1}=V_{FB2} = 0.75\text{V}$ , $V_{MODE} = 5.5\text{V}$		800	<span style="border: 1px solid black; padding: 0 2px;">1100</span>	$\mu\text{A}$
$I_{standby}$	Standby Current <sup>(2)</sup>	$V_{IN} = 5.5\text{V}$ , $V_{CE1} = V_{CE2} = 0\text{V}$		0	<span style="border: 1px solid black; padding: 0 2px;">10</span>	$\mu\text{A}$
$I_{CEH}$	CE "High" Input Current <sup>(1)</sup>	$V_{IN} = 5.5\text{V}$ , $V_{CE1} = V_{CE2} = 5.5\text{V}$	<span style="border: 1px solid black; padding: 0 2px;">-1</span>	0	<span style="border: 1px solid black; padding: 0 2px;">1</span>	$\mu\text{A}$
$I_{CEL}$	CE "Low" Input Current <sup>(1)</sup>	$V_{IN} = 5.5\text{V}$ , $V_{CE1} = V_{CE2} = 0\text{V}$	<span style="border: 1px solid black; padding: 0 2px;">-1</span>	0	<span style="border: 1px solid black; padding: 0 2px;">1</span>	$\mu\text{A}$
$I_{MODEH}$	MODE "H" Input Current	$V_{IN} = V_{MODE} = 5.5\text{V}$	<span style="border: 1px solid black; padding: 0 2px;">-1</span>	0	<span style="border: 1px solid black; padding: 0 2px;">1</span>	$\mu\text{A}$
$I_{MODEL}$	MODE "L" Input Current	$V_{IN} = 5.5\text{V}$ , $V_{MODE} = 0\text{V}$	<span style="border: 1px solid black; padding: 0 2px;">-1</span>	0	<span style="border: 1px solid black; padding: 0 2px;">1</span>	$\mu\text{A}$
$I_{FBH}$	$V_{FB}$ "High" Input Current <sup>(1)</sup>	$V_{IN}=V_{FB1}=V_{FB2}=5.5\text{V}$ , $V_{CE1}=V_{CE2}=0\text{V}$	<span style="border: 1px solid black; padding: 0 2px;">-1</span>	0	<span style="border: 1px solid black; padding: 0 2px;">1</span>	$\mu\text{A}$
$I_{FBL}$	$V_{FB}$ "Low" Input Current <sup>(1)</sup>	$V_{IN}=5.5\text{V}$ , $V_{CE1}=V_{CE2}=V_{FB1}=V_{FB2}=0\text{V}$	<span style="border: 1px solid black; padding: 0 2px;">-1</span>	0	<span style="border: 1px solid black; padding: 0 2px;">1</span>	$\mu\text{A}$
$I_{LXLEAKH}$	L <sub>X</sub> Leakage Current "High" <sup>(1)</sup>	$V_{IN} = V_{LX1} = V_{LX2} = 5.5\text{V}$ , $V_{CE1} = V_{CE2} = 0\text{V}$	<span style="border: 1px solid black; padding: 0 2px;">-1</span>	0	<span style="border: 1px solid black; padding: 0 2px;">5</span>	$\mu\text{A}$
$I_{LXLEAKL}$	L <sub>X</sub> Leakage Current "Low" <sup>(1)</sup>	$V_{IN}=5.5\text{V}$ , $V_{CE1}=V_{CE2}=V_{LX1}=V_{LX2}=0\text{V}$	<span style="border: 1px solid black; padding: 0 2px;">-6</span>	0	<span style="border: 1px solid black; padding: 0 2px;">1</span>	$\mu\text{A}$
$V_{CEH}$	CE "H" Input Voltage	$V_{IN} = 5.5\text{V}$	<span style="border: 1px solid black; padding: 0 2px;">1.0</span>			V
$V_{CEL}$	CE "L" Input Voltage	$V_{IN} = 2.3\text{V}$			<span style="border: 1px solid black; padding: 0 2px;">0.4</span>	V
$V_{MODEH}$	MODE "High" Input Voltage	$V_{IN} = 5.5\text{V}$	<span style="border: 1px solid black; padding: 0 2px;">1.0</span>			V
$V_{MODEL}$	MODE "Low" Input Voltage	$V_{IN} = 2.3\text{V}$			<span style="border: 1px solid black; padding: 0 2px;">0.4</span>	V
$R_{ONP}$	Pch.Transistor ON Resistance	$V_{IN} = 3.6\text{V}$ , $I_{LX1} = I_{LX2} = -100\text{mA}$		0.25		$\Omega$
$R_{ONN}$	Nch.Transistor ON Resistance	$V_{IN} = 3.6\text{V}$ , $I_{LX1} = I_{LX2} = -100\text{mA}$		0.21		$\Omega$
$T_{start}$	Soft-start Time	$V_{IN} = V_{CE1} = V_{CE2} = 3.6\text{V}$		200	<span style="border: 1px solid black; padding: 0 2px;">300</span>	$\mu\text{s}$
$I_{LXLIM}$	LX Limit Current	$V_{IN} = V_{CE1} = V_{CE2} = 3.6\text{V}$	<span style="border: 1px solid black; padding: 0 2px;">1400</span>	1900		mA
$t_{PROT}$	Protection Delay Time	$V_{IN} = V_{CE1} = V_{CE2} = 3.6\text{V}$	<span style="border: 1px solid black; padding: 0 2px;">0.5</span>	1.5	<span style="border: 1px solid black; padding: 0 2px;">5</span>	ms
$V_{UVLO1}$	UVLO Threshold Voltage	$V_{IN} = V_{CE1} = V_{CE2}$ , Falling	<span style="border: 1px solid black; padding: 0 2px;">1.9</span>	2.0	<span style="border: 1px solid black; padding: 0 2px;">2.1</span>	V
$V_{UVLO2}$		$V_{IN} = V_{CE1} = V_{CE2}$ , Rising	<span style="border: 1px solid black; padding: 0 2px;">2.0</span>	2.1	<span style="border: 1px solid black; padding: 0 2px;">2.2</span>	V
$T_{TSD}$	Thermal Shutdown Threshold Temperature	$T_j$ , Rising		165		$^{\circ}\text{C}$
$T_{TSR}$		$T_j$ , Falling			125	$^{\circ}\text{C}$

<sup>(1)</sup> Either Channel 1 value or Channel 2 value is indicated.

<sup>(2)</sup> The sum of Channel 1 and Channel 2 is indicated.

## THEORY OF OPERATION

### Soft-start

#### Starting-up with CE Pin

RP550L starts to operate when the CE pin voltage ( $V_{CE}$ ) exceeds the threshold voltage. The threshold voltage is preset between CE “High” input voltage ( $V_{CEH}$ ) and CE “Low” input voltage ( $V_{CEL}$ ). The soft-start circuit also starts to operate after the device start-up. Then, after a certain period of time, the reference voltage ( $V_{REF}$ ) in the device gradually increases up to the specified value.

Notes: Soft start time ( $t_{START}$ )<sup>(1)</sup> might not be always equal to an actual turn-on speed of the step-down DC/DC converter. Please note that the turn-on speed could be affected by the power supply capacity, the output current, the inductance value, and the  $C_{OUT}$  value.

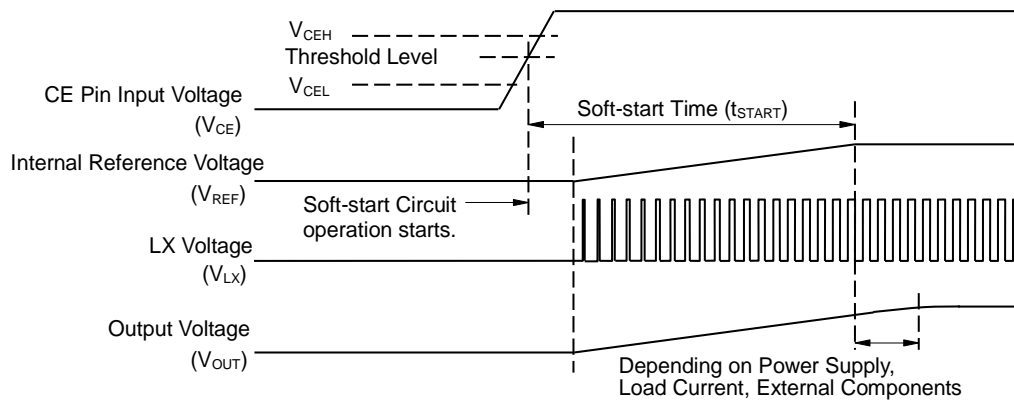

Timing Chart when Starting-up with CE Pin

#### Starting-up with Power Supply

After the power-on, the device starts to operate when  $V_{IN}$  exceeds the UVLO released voltage ( $V_{UVLO2}$ ). The soft-start circuit also starts to operate. Then after a certain period of time,  $V_{REF}$  gradually increases up to the specified value.

Notes: Please note that the turn-on speed of  $V_{OUT}$  could be affected by the following conditions.

1. Power supply capacity and Turn-on speed of  $V_{IN}$  determined by  $C_{IN}$
2. Output current and Output capacity of  $C_{OUT}$

<sup>(1)</sup> Soft-start time ( $t_{START}$ ) indicates the duration until the reference voltage ( $V_{REF}$ ) reaches the specified voltage after soft-start circuit's activation.

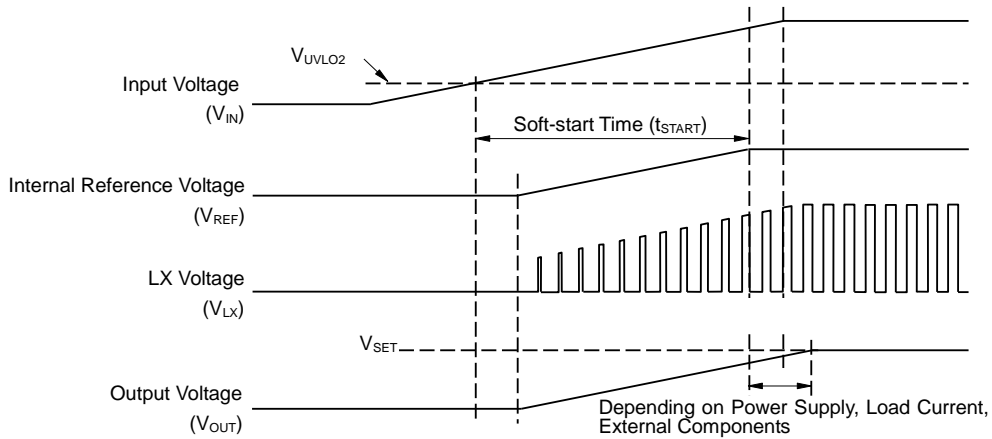

**Timing Chart when Starting-up with Power Supply**

**Under Voltage Lockout (UVLO)**

If  $V_{IN}$  becomes lower than  $V_{SET}$ , the step-down DC/DC converter stops the switching operation and ON duty becomes 100%, and then  $V_{OUT}$  gradually drops according to  $V_{IN}$ .

If the  $V_{IN}$  drops more and becomes lower than the UVLO detector threshold ( $V_{UVLO1}$ ), the UVLO circuit starts to operate,  $V_{REF}$  stops, and Pch. and Nch. built-in transistors become the OFF state. As a result,  $V_{OUT}$  drops according to the  $C_{OUT}$  capacitance value and the load.

To restart the operation,  $V_{IN}$  is required to be higher than  $V_{UVLO2}$ . The timing chart below shows the voltage shifts of  $V_{REF}$ ,  $V_{LX}$  and  $V_{OUT}$  in response to variation of the  $V_{IN}$  value.

Notes: Falling edge (operating) and rising edge (releasing) waveforms of  $V_{OUT}$  might be affected by the initial voltage of  $C_{OUT}$  and the output current of  $V_{OUT}$ .

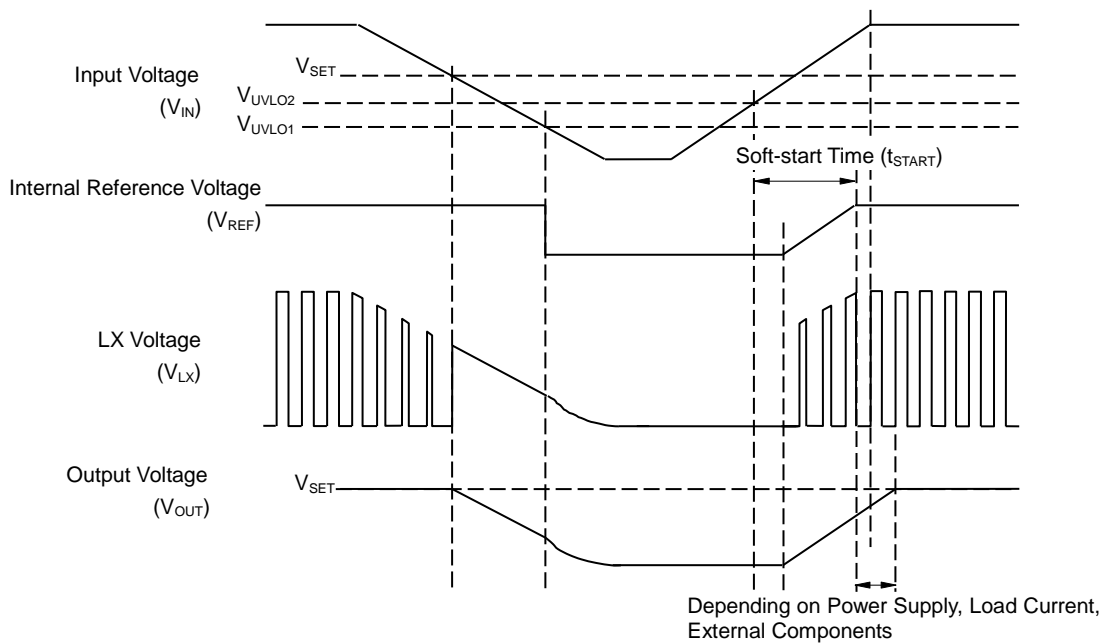



**Timing Chart with Variations in Input Voltage (V<sub>IN</sub>)**

**Current limit Function**

Current limit circuit supervises the inductor peak current (the current flowing through Pch. transistor) in each switching cycle, and if the current exceeds the LX current limit (I<sub>LXLIM</sub>), Pch. transistor is turned off. I<sub>LXLIM</sub> of the RP550L001B is Typ.1.9 A.

**Latch Type Protection**

Latch type protection circuit latches the built-in driver in the OFF state and stops the operation of the step-down DC/DC converter, if the over current status or V<sub>OUT</sub> being dropped to the half of the setting voltage due to shorting continues for the protection delay time (t<sub>PROT</sub>).

To release the latch type protection circuit, restart the device by inputting "L" signal to the CE pin or making the supply voltage lower than V<sub>UVLO1</sub>.

Notes: I<sub>LXLIM</sub> and t<sub>PROT</sub> could be easily affected by self-heating or ambient environment. If the V<sub>IN</sub> drops dramatically or becomes unstable due to short-circuit, protection operation and t<sub>PROT</sub> could be affected.

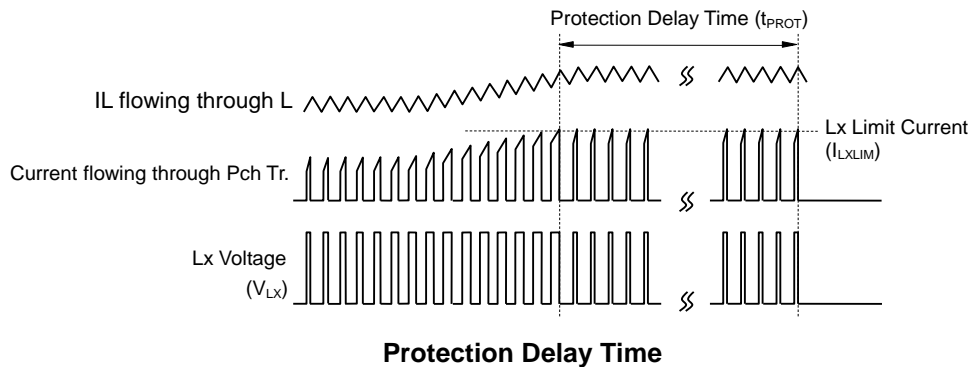

---

**RP550L001B**

---

NO.EC-285-170906

The timing chart below shows the voltage shift of  $V_{CE}$ ,  $V_{LX}$  and  $V_{OUT}$  when the device status is changed by the following orders:  $V_{IN}$  rising → stable operation → high load → CE reset → stable operation →  $V_{IN}$  falling →  $V_{IN}$  recovering (UVLO reset) → stable operation.

- (1)(2) If the large current flows through the circuit or the device goes into low  $V_{OUT}$  condition due to short-circuit or other reasons, the latch type protection circuit latches the built-in driver to "OFF" state after  $t_{PROT}$ . Then,  $V_{LX}$  becomes "L" and  $V_{OUT}$  turns "OFF".
- (3) The latch type protection circuit is released by CE reset, which puts the device into "L" once with the CE pin and back into "H".
- (4) The latch type protection circuit is released by UVLO reset, which makes  $V_{IN}$  lower than  $V_{UVLO1}$ .

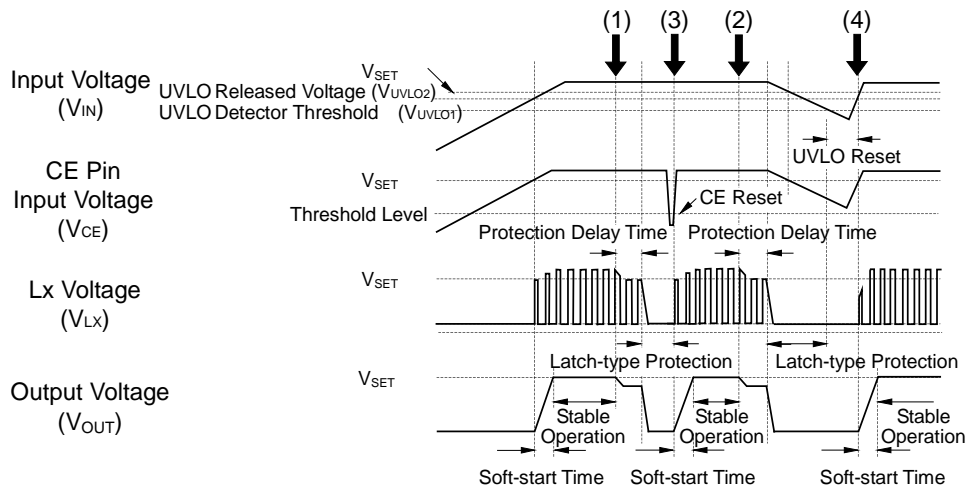
**Timing Chart**

**Operation of Step-down DC/DC Converter and Output Current**

The step-down DC/DC converter charges energy in the inductor when LX transistor turns “ON”, and discharges the energy from the inductor when LX transistor turns “OFF” and controls with less energy loss, so that a lower output voltage ( $V_{OUT}$ ) than the input voltage ( $V_{IN}$ ) can be obtained. The operation of the step-down DC/DC converter is explained in the following figures.

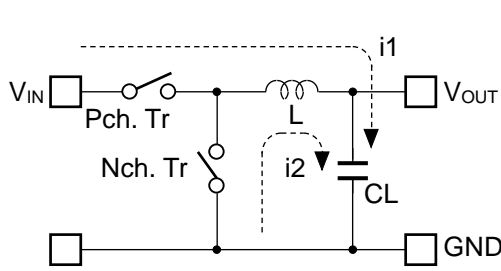

**Basic Circuit**

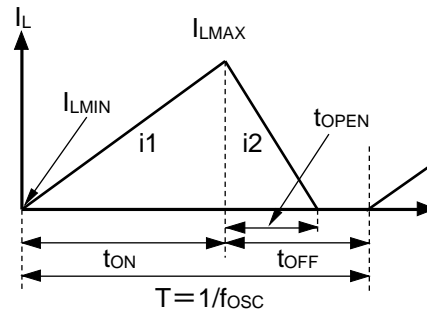

**Inductor Current ( $I_L$ ) flowing through Inductor (L)**

- Step1.** Pch. transistor turns “ON” and  $I_L$  ( $i1$ ) flows, L is charged with energy. At this moment,  $i1$  increases from the minimum inductor current ( $I_{LMIN}$ ), which is 0 A, and reaches the maximum inductor current ( $I_{LMAX}$ ) in proportion to the on-time period ( $t_{ON}$ ) of Pch. transistor.
- Step2.** When Pch. transistor turns “OFF”, L tries to maintain  $I_L$  at  $I_{LMAX}$ , so L turns Nch. transistor “ON” and  $I_L$  ( $i2$ ) flows into L.
- Step3.**  $i2$  decreases gradually and reaches  $I_{LMIN}$  after the open-time period ( $t_{OPEN}$ ) of NMOS transistor, and then Nch. transistor turns “OFF”. This is called discontinuous current mode.  
As the output current ( $I_{OUT}$ ) increases, the off-time period ( $t_{OFF}$ ) of Pch. transistor runs out before  $I_L$  reaches  $I_{LMIN}$ . The next cycle starts, and Pch. transistor turns “ON” and Nch. transistor turns “OFF”, which means  $I_L$  starts increasing from  $I_{LMIN}$ . This is called continuous current mode.

In PWM mode,  $V_{OUT}$  is maintained by controlling  $t_{ON}$ . The oscillator frequency ( $f_{OSC}$ ) is maintained constant during PWM mode.

When the step-down DC/DC operation is constant,  $I_{LMIN}$  and  $I_{LMAX}$  during  $t_{ON}$  of Pch. transistor would be same as during  $t_{OFF}$  of Pch. transistor. The current differential between  $I_{LMAX}$  and  $I_{LMIN}$  is described as  $\Delta I$ , as the following equation 1.

$$\Delta I = I_{LMAX} - I_{LMIN} = V_{OUT} \times t_{OPEN} / L = (V_{IN} - V_{OUT}) \times t_{ON} / L \dots\dots\dots \text{Equation 1}$$

The above equation is predicated on the following requirements.

$$T = 1 / f_{OSC} = t_{ON} + t_{OFF}$$

$$\text{duty (\%)} = t_{ON} / T \times 100 = t_{ON} \times f_{OSC} \times 100$$

$$t_{OPEN} \leq t_{OFF}$$

In Equation 1, “ $V_{OUT} \times t_{OPEN} / L$ ” shows the amount of current change in “OFF” state. Also, “ $(V_{IN} - V_{OUT}) \times t_{ON} / L$ ” shows the amount of current change at “ON” state.

**Discontinuous Mode and Continuous Mode**

As illustrated in Figure A., when  $I_{OUT}$  is relatively small,  $t_{OPEN} < t_{OFF}$ . In this case, the energy charged into  $L$  during  $t_{ON}$  will be completely discharged during  $t_{OFF}$ , as a result,  $I_{LMIN} = 0$ . This is called discontinuous mode. When  $I_{OUT}$  is gradually increased, eventually  $t_{OPEN} = t_{OFF}$  and when  $I_{OUT}$  is increased further, eventually  $I_{LMIN} > 0$  as illustrated in Figure B. This is called continuous mode.

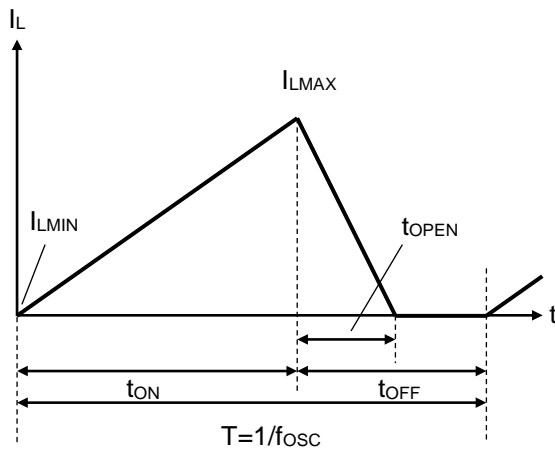
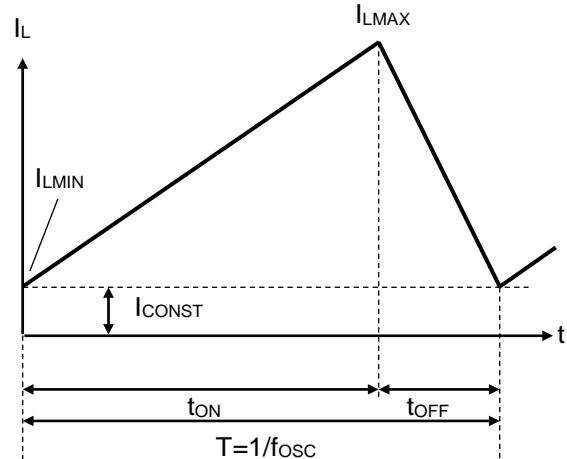
**Figure A. Discontinuous Mode****Figure B. Continuous Mode**

In the continuous mode, the solution of Equation 1 is described as  $t_{ONC}$ .

$$t_{ONC} = T \times V_{OUT} / V_{IN} \dots\dots\dots \text{Equation 2}$$

When  $t_{ON} < t_{ONC}$ , it is discontinuous mode, and when  $t_{ON} = t_{ONC}$ , it is continuous mode.

**Forced PWM Mode and VFM Mode**

Operating mode to control the output voltage is selectable between a forced PWM mode and a PWM/VFM auto-switching mode, and can be set by the MODE pin. The forced PWM control switches at fixed frequency rate in order to reduce noise in low output current. The PWM/VFM auto-switching control automatically switches from PWM mode to VFM mode in order to achieve high efficiency in low output current.

**Forced PWM Mode**

By setting the MODE pin to "H", the device switches the frequency at the fixed rate to reduce noise even when the output load is light. Therefore, when  $I_{OUT}$  is  $\Delta I_L/2$  or less,  $I_{LMIN}$  becomes less than "0". That is, the accumulated charge in  $C_{OUT}$  is discharged through the internal transistor while  $I_L$  is increasing from  $I_{LMIN}$  to "0"

during  $t_{ON}$ , and also while  $I_L$  is decreasing from "0" to  $I_{LMIN}$  during  $t_{OFF}$ .

**VFM Mode**

By setting the MODE pin to "L", in low output current, the device automatically switches into VFM mode in order to achieve high efficiency. In VFM mode,  $t_{ON}$  is forced to end when the inductor current reaches the pre-set  $I_{LMAX}$ . In the VFM mode,  $I_{LMAX}$  is typically set to 280 mA for the RP550L001B. When  $t_{ON}$  reaches 1.5 times of  $T = 1 / f_{OSC}$ ,  $t_{ON}$  will be forced to end even if the inductor current is not reached  $I_{LMAX}$ .

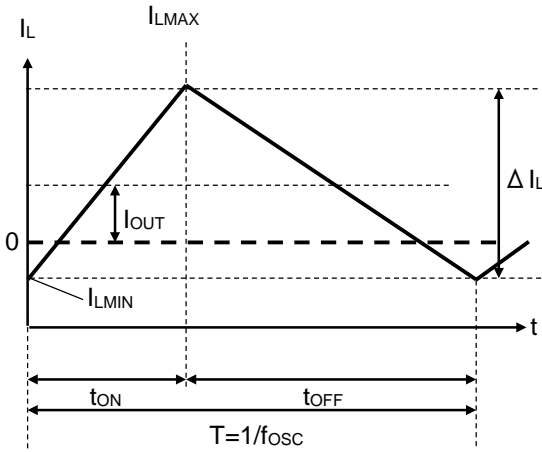

**Forced PWM Mode**

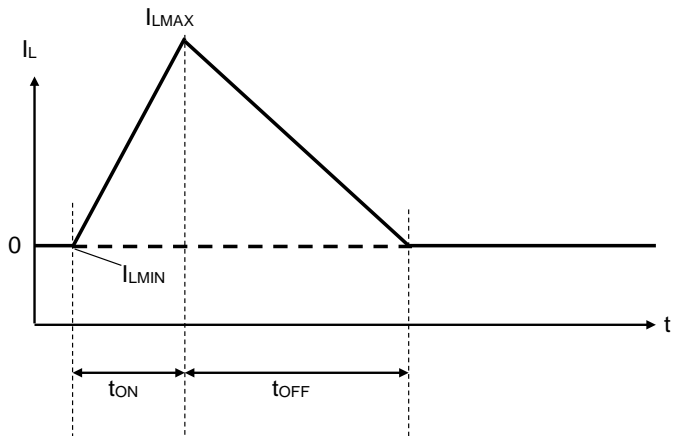

**VFM Mode**

# RP550L001B

NO.EC-285-170906

## APPLICATION INFORMATION

### Typical Application Circuit

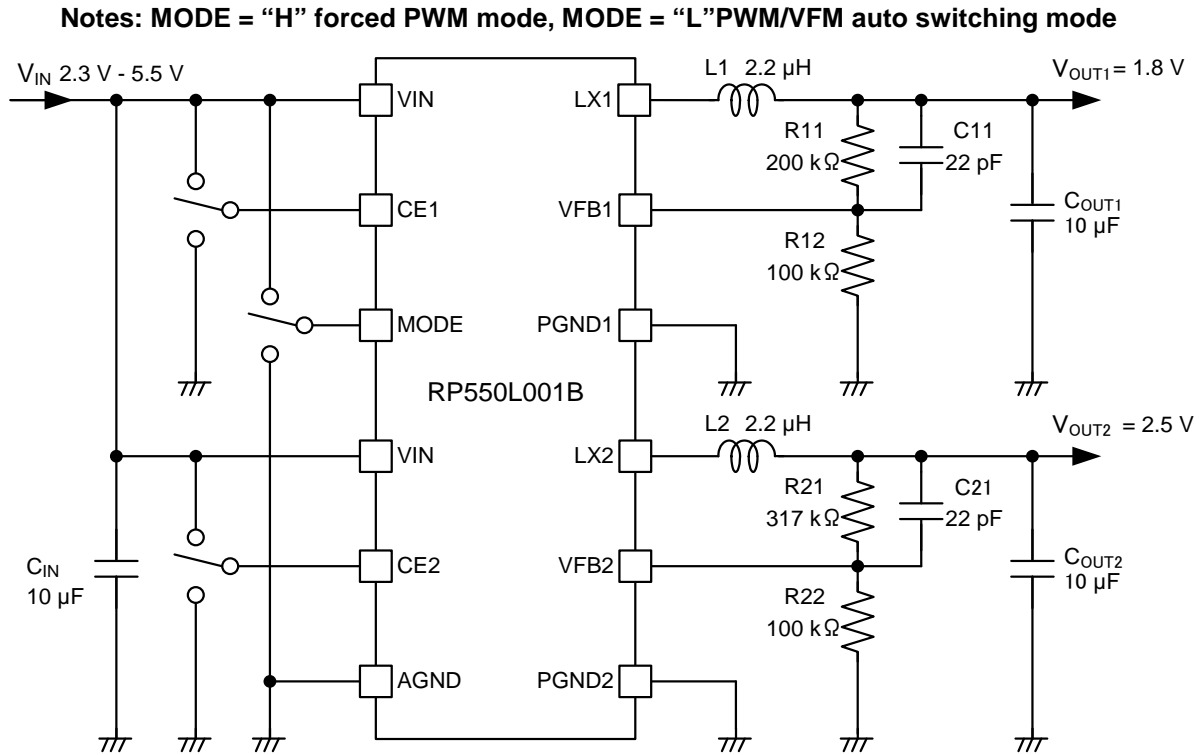

RP550L001B Typical Application Circuit

### Recommended External Components

**Table 1. Recommended External Components:  $0.8V \leq V_{SET} \leq 3.3V$**

Symbol	Value	Components	Part Number
C <sub>IN</sub>	10 μF	Ceramic Capacitor	CGA4J1X7R0J106K125AC (TDK)
C <sub>OUT</sub>	10 μF	Ceramic Capacitor	CGA4J1X7R0J106K125AC (TDK)
L	2.2 μH	Inductor	VLS3012ET-2R2M-CA (TDK)

**Table 2. Recommended External Components:  $0.6V \leq V_{SET} < 0.8V$**

Symbol	Value	Components	Part Number
C <sub>IN</sub>	10 μF	Ceramic Capacitor	CGA4J1X7R0J106K125AC (TDK)
C <sub>OUT</sub>	10 μF × 2	Ceramic Capacitor	CGA4J1X7R0J106K125AC (TDK)
L	1.5 μH	Inductor	VLS3012ET-1R5N-CA (TDK)

**Cautions in selecting external parts**

- Choose a low ESR ceramic capacitor. The ceramic capacitance of a capacitor ( $C_{IN}$ ) connected between  $V_{IN}$  and GND should be more than or equal to  $10\mu\text{F}$ . The ceramic capacitance of a capacitor ( $C_{OUT}$ ) connected between  $V_{OUT}$  and GND should be  $10\mu\text{F}$  to  $20\mu\text{F}$ . Please be aware of the characteristics of bias dependence and temperature fluctuation of ceramic capacitor.
- Choose an inductor that has small DC resistance, has enough permissible current and is hard to cause magnetic saturation. If the inductance value of the inductor becomes extremely small under the load conditions, the peak current of LX may increase along with the load current. As a result, over current protection circuit may start to operate when the peak current of LX reaches to LX limit current. Therefore, choose an inductor with consideration for the value of  $I_{LXMAX}$ .
- The output voltage ( $V_{OUT1}$ ,  $V_{OUT2}$ ) is adjustable by changing the resistance values of resistors (R11 and R12, R21 and R22) as follows.

$$V_{OUT1} = 0.6 \times (R11 + R12) / R12 \quad (\text{Recommended range: } 0.6 \text{ V} \leq V_{OUT1} \leq 3.3 \text{ V})$$

$$V_{OUT2} = 0.6 \times (R21 + R22) / R22 \quad (\text{Recommended range: } 0.6 \text{ V} \leq V_{OUT2} \leq 3.3 \text{ V})$$

If R11, R12, R21, and R22 are too large, the impedances of  $V_{FB1}$  and  $V_{FB2}$  also become large, as a result, the device could be easily affected by noise. For this reason, R12 and R22 should be  $100\text{k}\Omega$  or less. If the operation becomes unstable due to the high impedances, the impedances should be decreased.

C11 and C21 can be calculated by the following equations. Please use the value close to the calculation result.

$$C11 = 2.2 \times 10^{-6} / R12 \text{ [F]} \quad (0.6\text{V} \leq V_{OUT1} \leq 3.3\text{V})$$

$$C21 = 2.2 \times 10^{-6} / R22 \text{ [F]} \quad (0.6\text{V} \leq V_{OUT2} \leq 3.3\text{V})$$

The recommended resistance values for R11, R12, R21, R22, C11, and C21 are as follows.

**Recommended Resistor and Capacitor Values**

Output Voltage $V_{OUT1}, V_{OUT2}$ [V]	Resistor [k $\Omega$ ]		Capacitor [pF]
	R11, R21	R12, R22	C11, C21
0.6	0	100	-
0.7	16.7	100	22
0.8	33.3	100	22
1.2	100	100	22
1.8	200	100	22
2.5	317	100	22
3.3	450	100	22

**Calculation Conditions of LX Pin Maximum Output Current ( $I_{LXMAX}$ )**

The following equations explain the relationship to determine  $I_{LXMAX}$  at the ideal operation of the device in continuous mode.

$I_{RP}$  : Ripple Current P-P value

$R_{ONP} / R_{ONN}$  : ON resistance of Pch. / Nch. transistor

$R_L$  : DC resistor of the inductor

First, when the Pch. transistor is "ON", Equation 1 is satisfied.

$$V_{IN} = V_{OUT} + (R_{ONP} + R_L) \times I_{OUT} + L \times I_{RP} / t_{ON} \dots \dots \dots \text{Equation 1}$$

Second, when the Pch. transistor is "OFF" (the Nch. transistor is "ON"), Equation 2 is satisfied.

$$L \times I_{RP} / t_{OFF} = R_{ONN} \times I_{OUT} + V_{OUT} + R_L \times I_{OUT} \dots \dots \dots \text{Equation 2}$$

Put Equation 2 into Equation 1 to solve ON duty of the Pch. transistor ( $D_{ON} = t_{ON} / (t_{OFF} + t_{ON})$ ):

$$D_{ON} = (V_{OUT} + R_{ONN} \times I_{OUT} + R_L \times I_{OUT}) / (V_{IN} + R_{ONN} \times I_{OUT} - R_{ONP} \times I_{OUT}) \dots \dots \dots \text{Equation 3}$$

Ripple Current is described as follows:

$$I_{RP} = (V_{IN} - V_{OUT} - R_{ONP} \times I_{OUT} - R_L \times I_{OUT}) \times D_{ON} / f_{OSC} / L \dots \dots \dots \text{Equation 4}$$

Peak current that flows through L, and LX transistor is described as follows:

$$I_{LXMAX} = I_{OUT} + I_{RP} / 2 \dots \dots \dots \text{Equation 5}$$



## TECHNICAL NOTES

The performance of a power source circuit using this device is highly dependent on a peripheral circuit. A peripheral component or the device mounted on PCB should not exceed a rated voltage, a rated current or a rated power. When designing a peripheral circuit, please be fully aware of the following points.

- AGND, PGND1 and PGND2 must be wired to the GND plane when mounting on boards.
- The VIN pins must be wired to the V<sub>IN</sub> plane when mounting on boards.
- Ensure the V<sub>IN</sub> and GND lines are sufficiently robust. A large switching current flows through the GND line, the V<sub>DD</sub> line, the V<sub>OUT</sub> line, an inductor, and LX. If their impedance is too high, noise pickup or unstable operation may result. Set external components as close as possible to the device and minimize the wiring between the components and the device, especially between a capacitor and the VIN pin. The wiring between V<sub>FB</sub> and load and between L and V<sub>OUT</sub> should be separated.
- Over current protection circuit and latch type protection circuit may be affected by self-heating or power dissipation environment.

### PCB Layout Board

RP550L001B (PKG: DFN3030-12 pin)

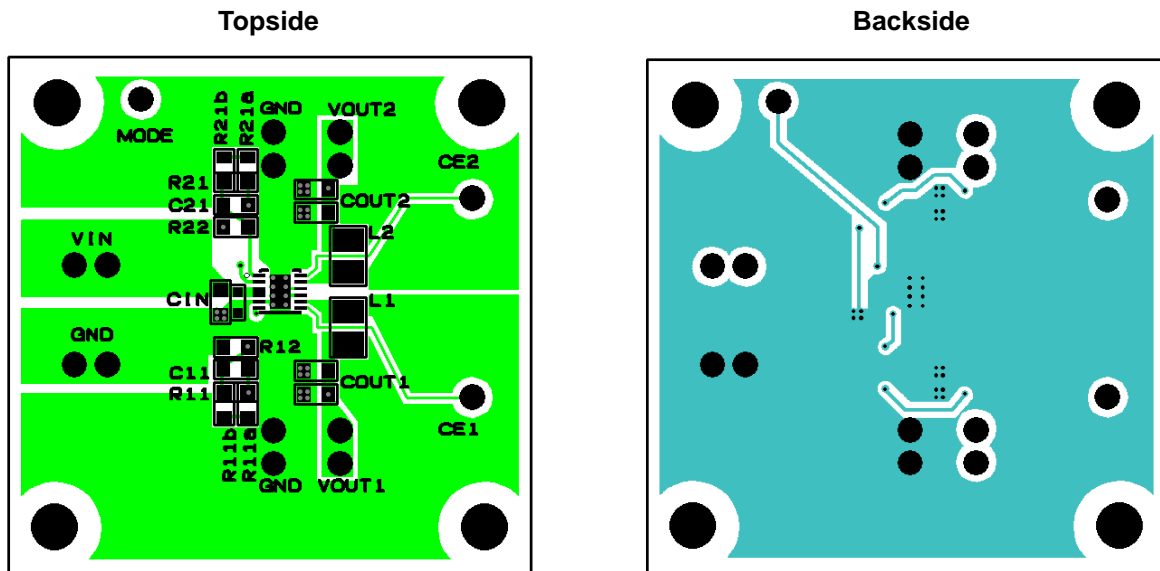

\* For supporting the series connection of R11 and R21, R11a and R11b are arranged in series. Likewise, R21a and R22b are arranged in series.

# RP550L001B

NO.EC-285-170906

## TYPICAL CHARACTERISTICS

Typical Characteristics are intended to be used as reference data, they are not guaranteed.

### 1) Output Voltage vs. Output Current

RP550L001B  $V_{OUT} = 0.6 V$   
MODE = "L", PWM/VFM Auto-Switching Control

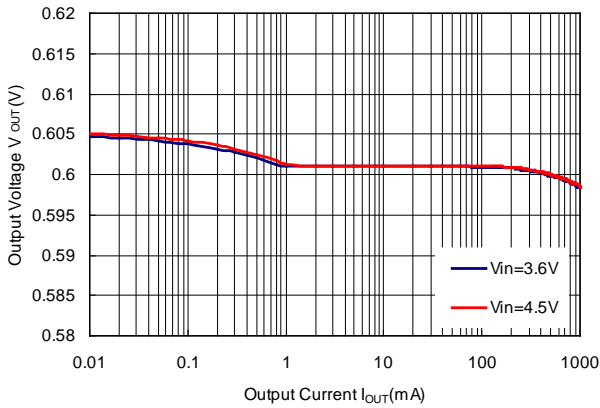

RP550L001B  $V_{OUT} = 0.6 V$   
MODE = "H", Forced PWM Control

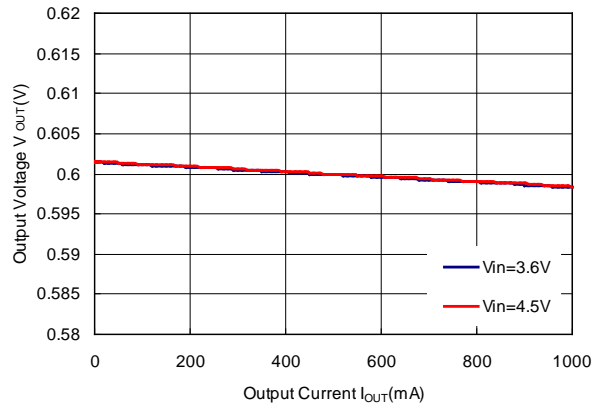

RP550L001B  $V_{OUT} = 0.8 V$   
MODE = "L", PWM/VFM Auto-Switching Control

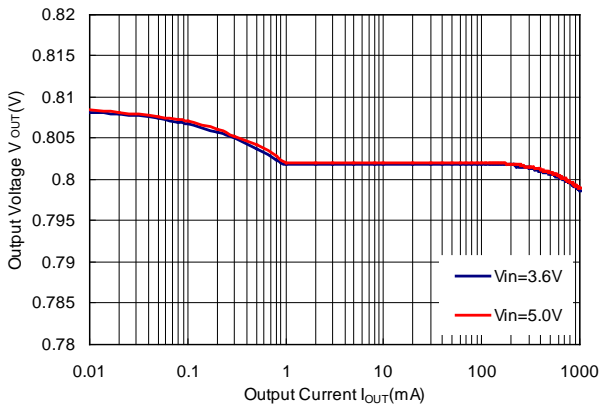

RP550L001B  $V_{OUT} = 0.8 V$   
MODE = "H", Forced PWM Control

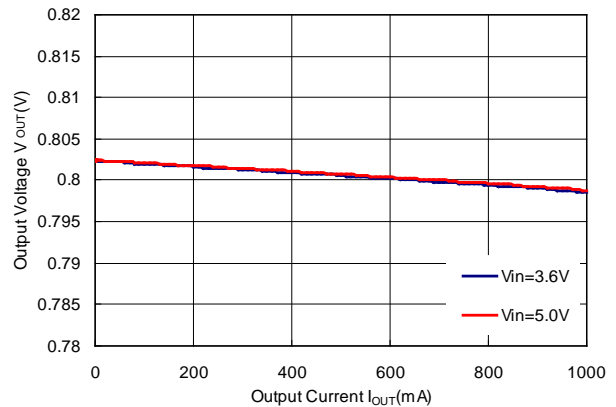

RP550L001B  $V_{OUT} = 1.2 V$   
MODE = "L", PWM/VFM Auto-Switching Control

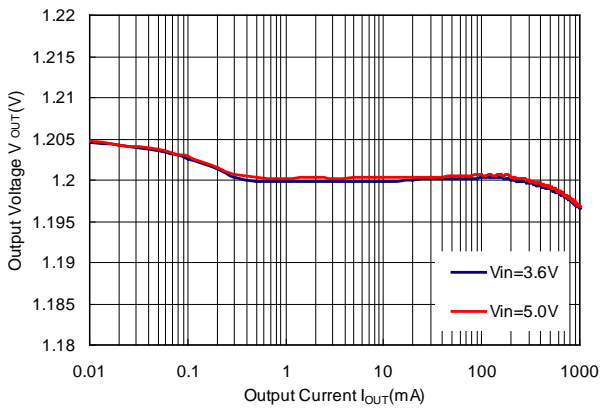

RP550L001B  $V_{OUT} = 1.2 V$   
MODE = "H", Forced PWM Control

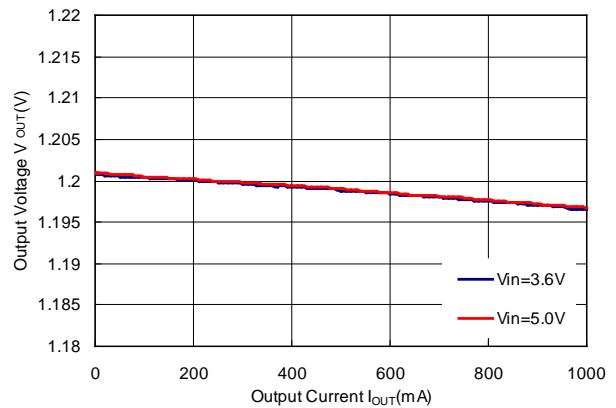

RP550L001B  $V_{OUT} = 1.8\text{ V}$   
MODE = "L", PWM/VFM Auto-Switching Control

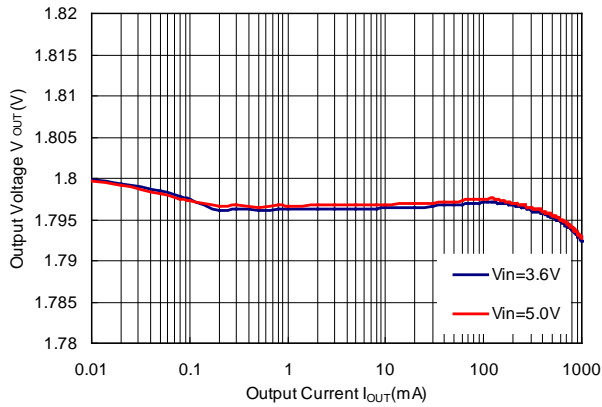

RP550L001B  $V_{OUT} = 1.8\text{ V}$   
MODE = "H", Forced PWM Control

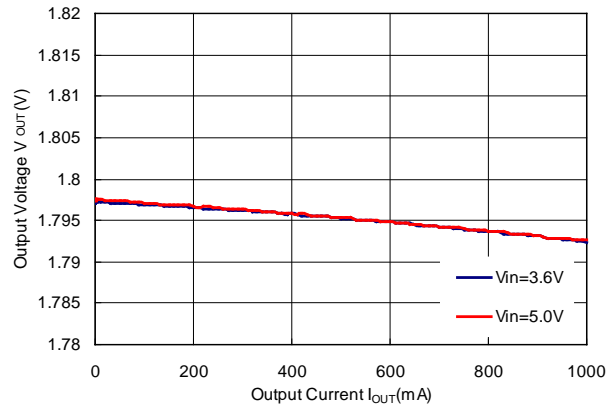

RP550L001B  $V_{OUT} = 3.3\text{ V}$   
MODE = "L", PWM/VFM Auto-Switching Control

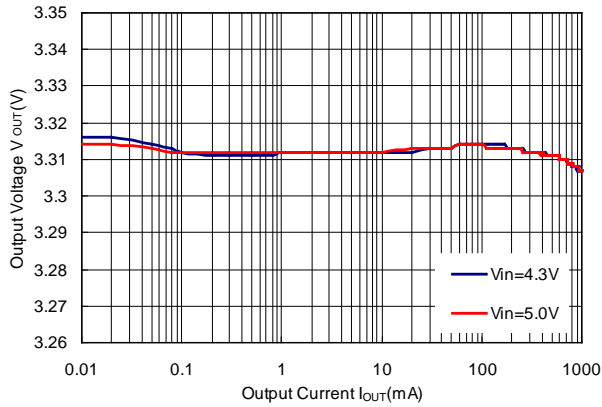

RP550L001B  $V_{OUT} = 3.3\text{ V}$   
MODE = "H", Forced PWM Control

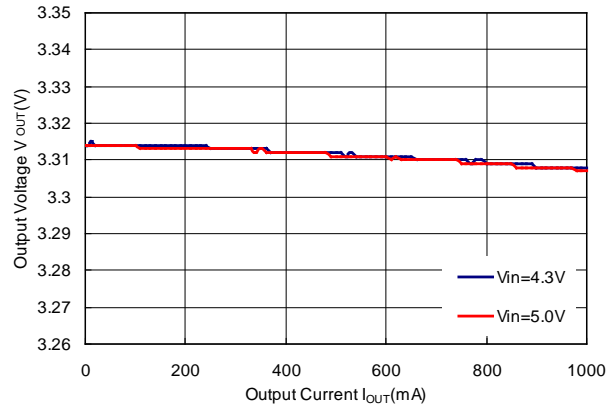

2) Output Voltage vs. Input Voltage

RP550L001B  $V_{OUT} = 0.8\text{ V}$   
MODE = "H", Forced PWM Control

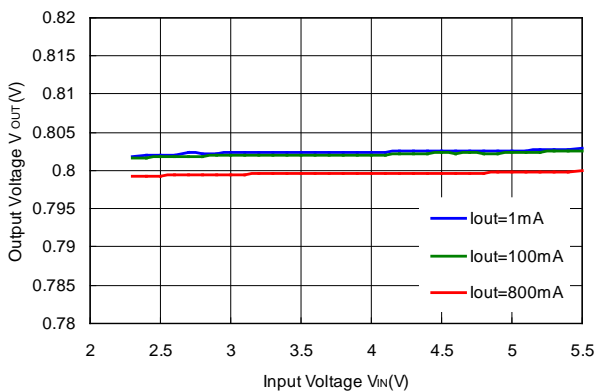

RP550L001B  $V_{OUT} = 1.2\text{ V}$   
MODE = "H", Forced PWM Control

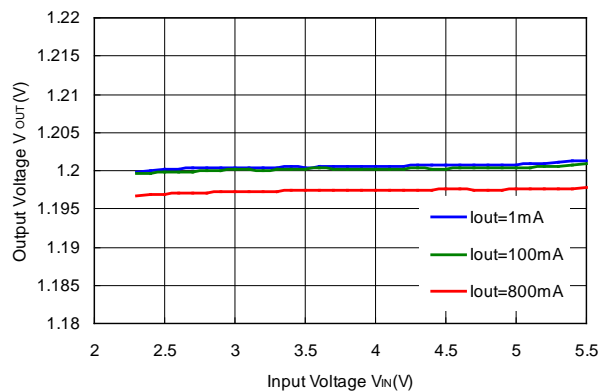

# RP550L001B

NO.EC-285-170906

RP550L001B  $V_{OUT} = 1.8\text{ V}$   
MODE = "H", Forced PWM Control

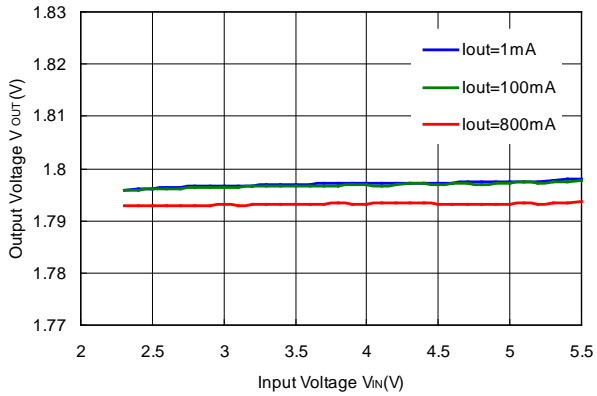

RP550L001B  $V_{OUT} = 3.3\text{ V}$   
MODE = "H", Forced PWM Control

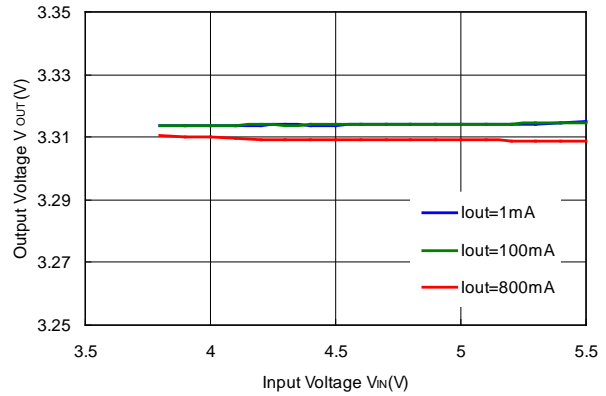

### 3) Feedback Voltage vs. Ambient Temperature

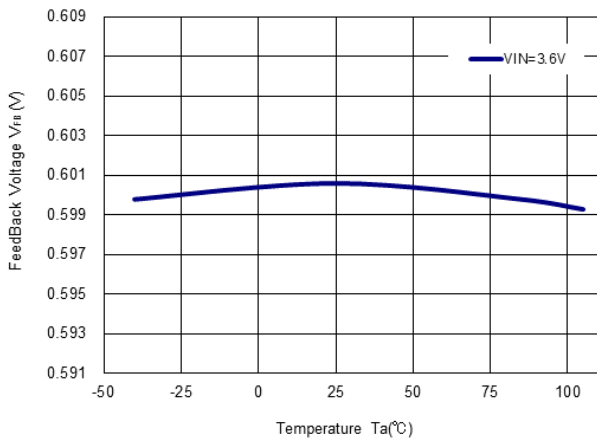

### 4) Efficiency vs. Output Current RP550L001B $V_{OUT} = 0.6\text{ V}$

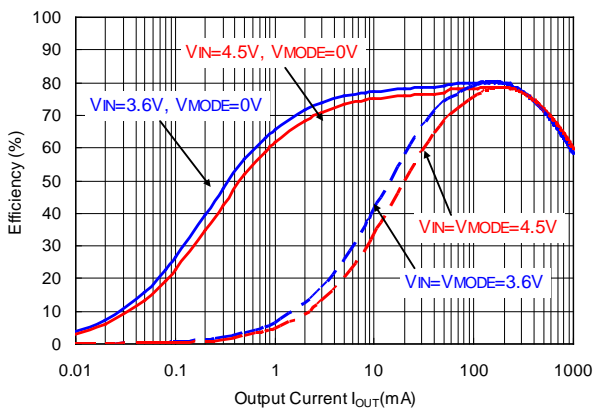

### RP550L001B $V_{OUT} = 0.8\text{ V}$

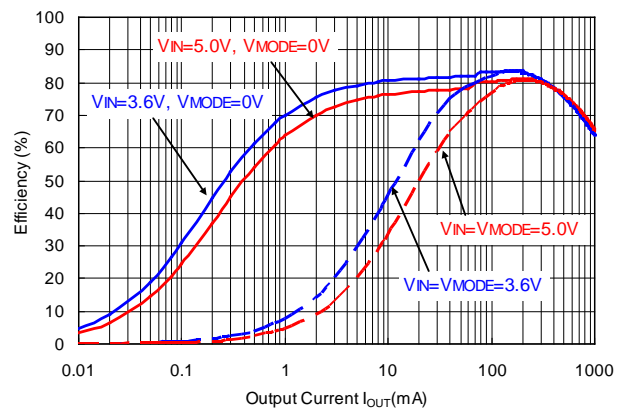

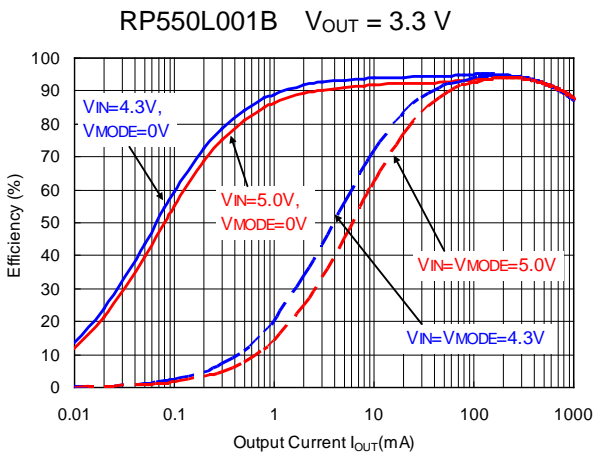
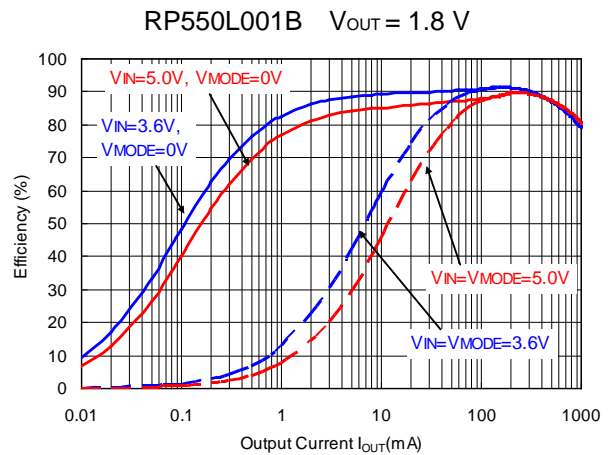
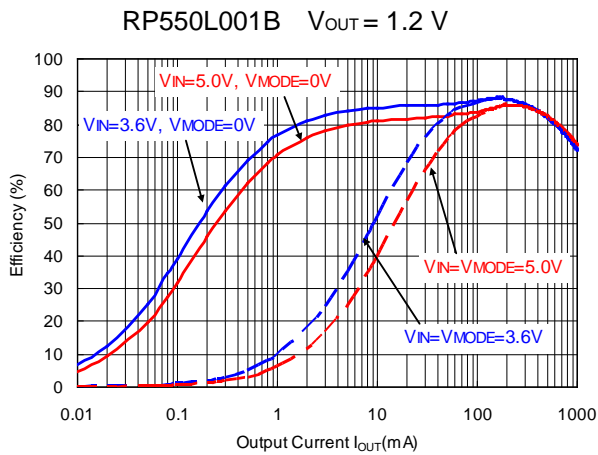

5) Supply Current vs. Ambient Temperature  
 RP550L001B  $V_{OUT} = 1.8\text{ V}$  ( $V_{IN} = 5.5\text{ V}$ )  
 MODE = "L", PWM/VFM Auto-Switching Control

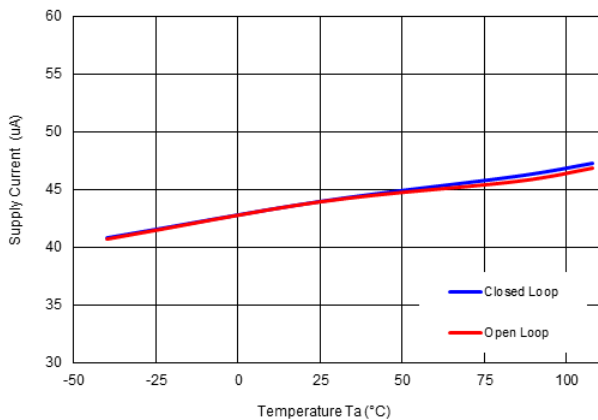

6) Supply Current vs. Input Voltage  
 RP550L001B  $V_{OUT} = 1.8\text{ V}$   
 MODE = "L", PWM/VFM Auto-Switching Control

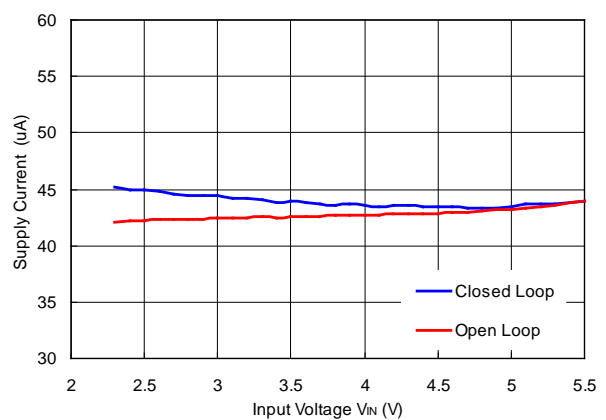

# RP550L001B

NO.EC-285-170906

## 7) Output Voltage Waveform

RP550L001B  $V_{OUT} = 0.6\text{ V}$  ( $V_{IN} = 3.6\text{ V}$ )  
MODE = "L", PWM/VFM Auto-Switching Control

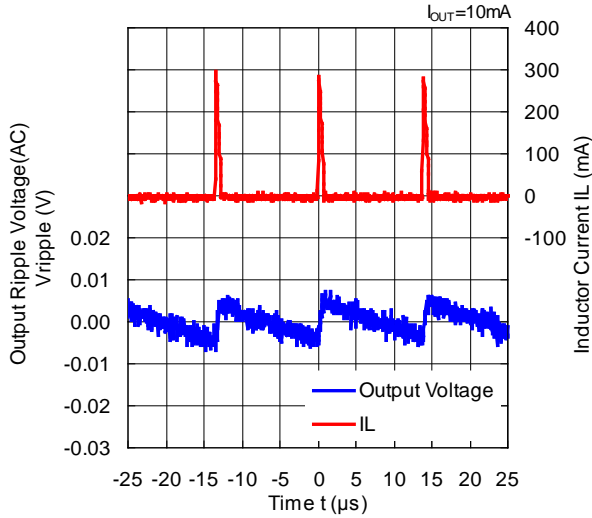

RP550L001B  $V_{OUT} = 0.6\text{ V}$  ( $V_{IN} = 3.6\text{ V}$ )  
MODE = "H", Forced PWM Control

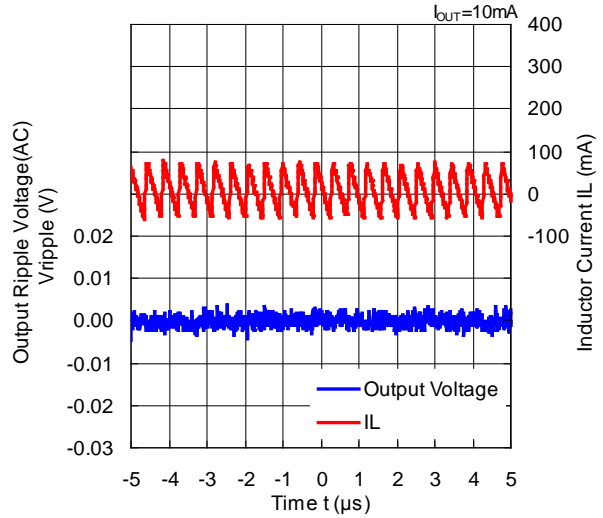

RP550L001B  $V_{OUT} = 0.8\text{ V}$  ( $V_{IN} = 3.6\text{ V}$ )  
MODE = "L", PWM/VFM Auto-Switching Control

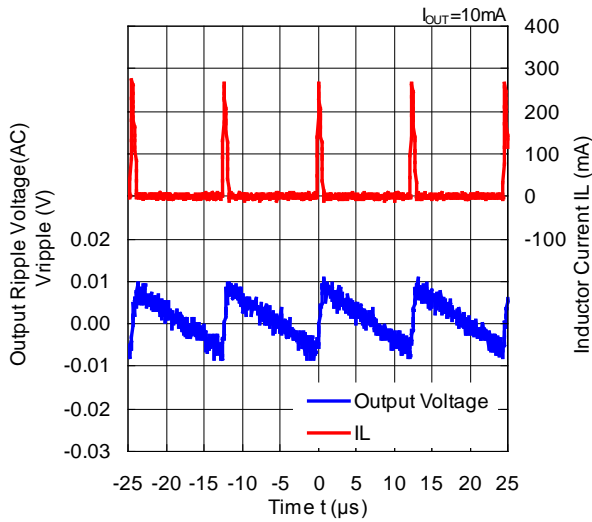

RP550L001B  $V_{OUT} = 0.8\text{ V}$  ( $V_{IN} = 3.6\text{ V}$ )  
MODE = "H", Forced PWM Control

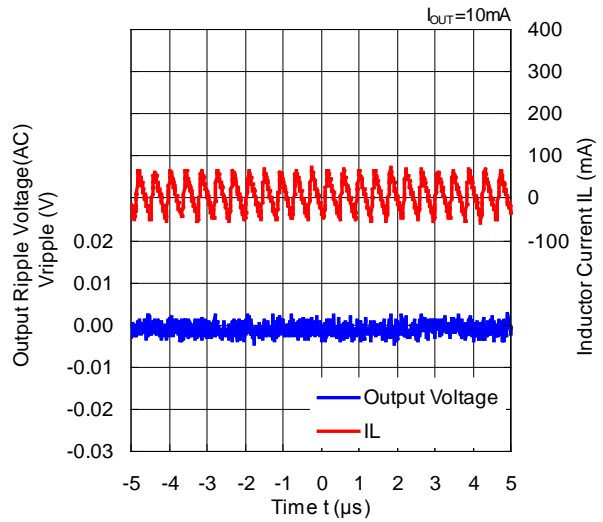

RP550L001B  $V_{OUT} = 1.2\text{ V}$  ( $V_{IN} = 3.6\text{ V}$ )  
 MODE = "L", Auto-Switching Control

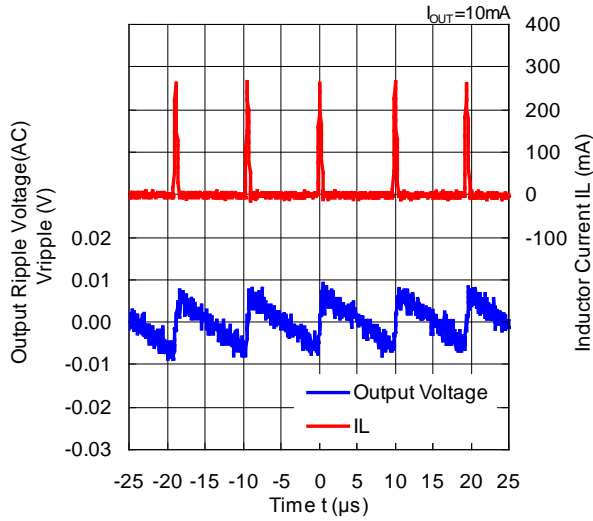

RP550L001B  $V_{OUT} = 1.2\text{ V}$  ( $V_{IN} = 3.6\text{ V}$ )  
 MODE = "H", Forced PWM Control

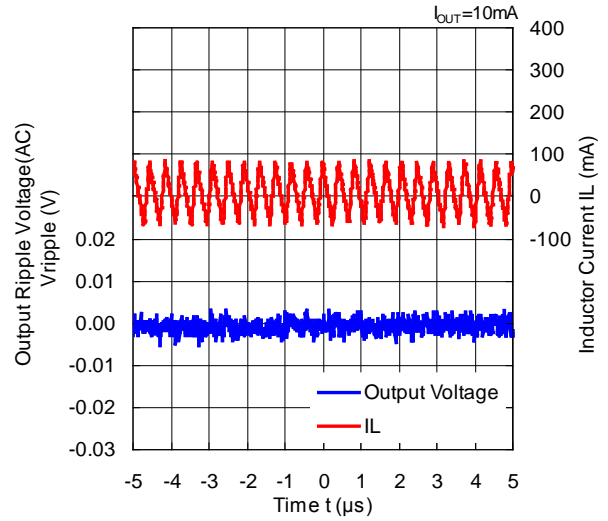

RP550L001B  $V_{OUT} = 1.8\text{ V}$  ( $V_{IN} = 3.6\text{ V}$ )  
 MODE = "L", PWM/VFM Auto-Switching Control

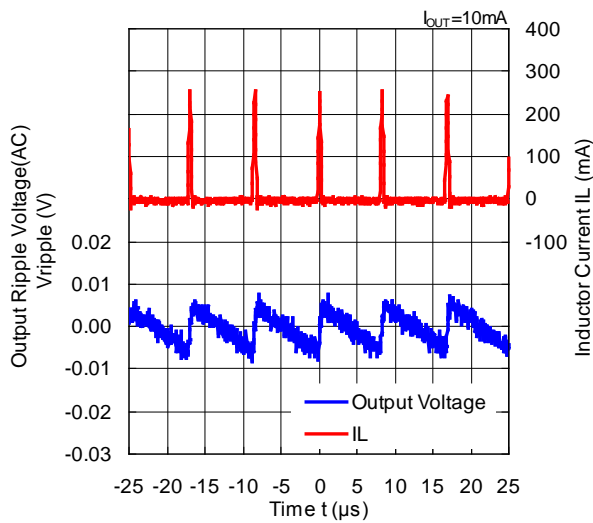

RP550L001B  $V_{OUT} = 1.8\text{ V}$  ( $V_{IN} = 3.6\text{ V}$ )  
 MODE = "H", Forced PWM Control

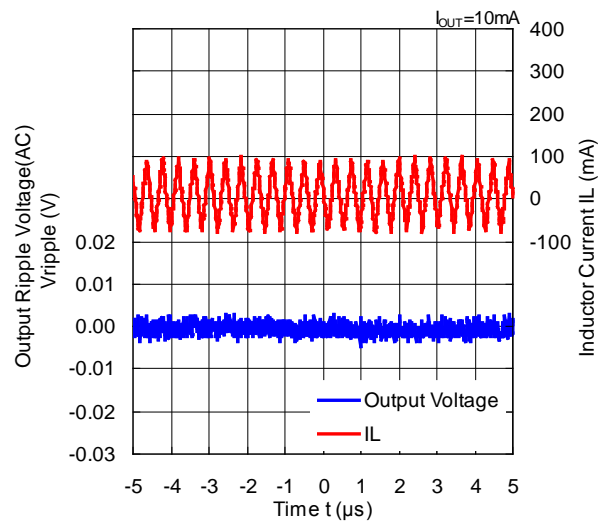

# RP550L001B

NO.EC-285-170906

RP550L001B  $V_{OUT} = 3.3\text{ V}$  ( $V_{IN} = 4.3\text{ V}$ )  
 MODE = "L", PWM/VFM Auto-Switching Control

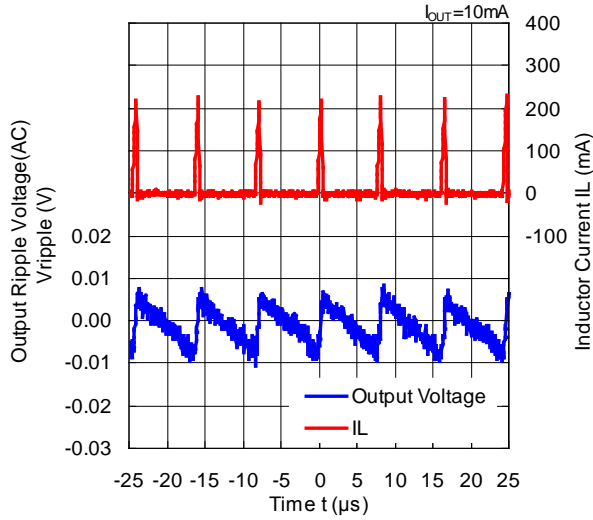

RP550L001B  $V_{OUT} = 3.3\text{ V}$  ( $V_{IN} = 4.3\text{ V}$ )  
 MODE = "H", Forced PWM Control

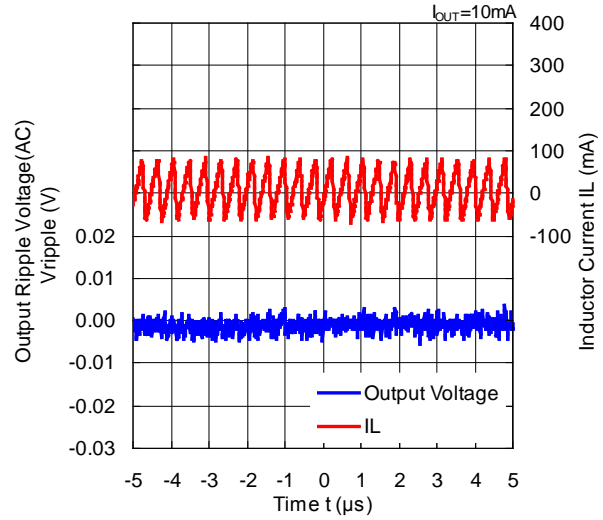

## 8) Oscillator Frequency vs. Ambient Temperature

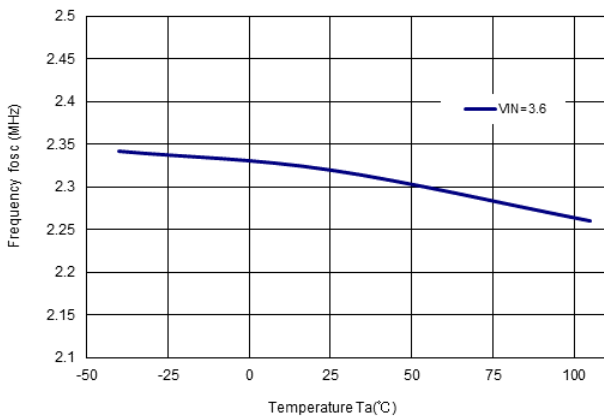

## 9) Oscillator Frequency vs. Input Voltage

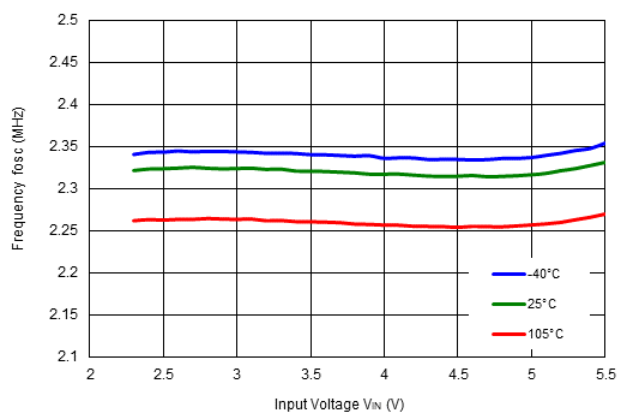

## 10) Soft-start Time vs. Ambient Temperature

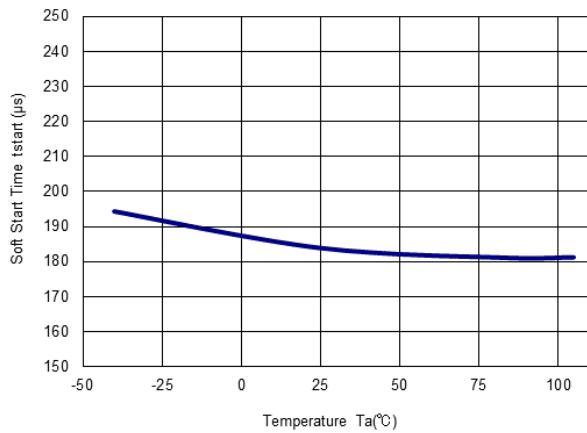



11) UVLO Detector/ Released Threshold vs. Ambient Temperature

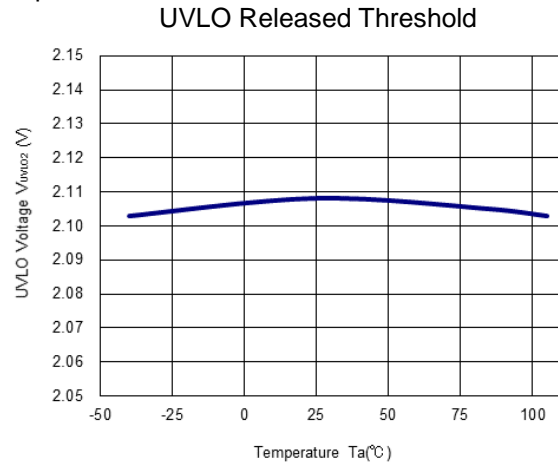
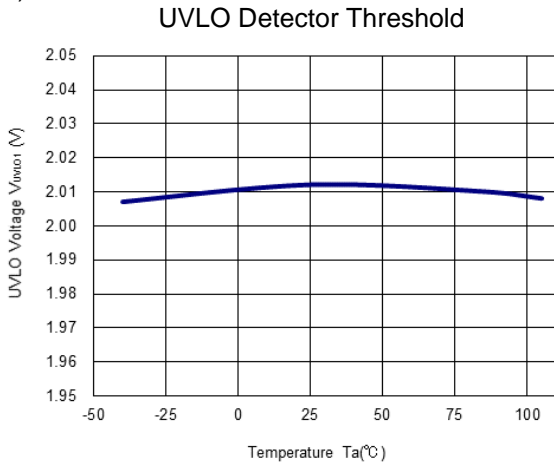

12) CE Input Voltage vs. Ambient Temperature  
CE "H" Input Voltage (V<sub>IN</sub> = 5.5 V)

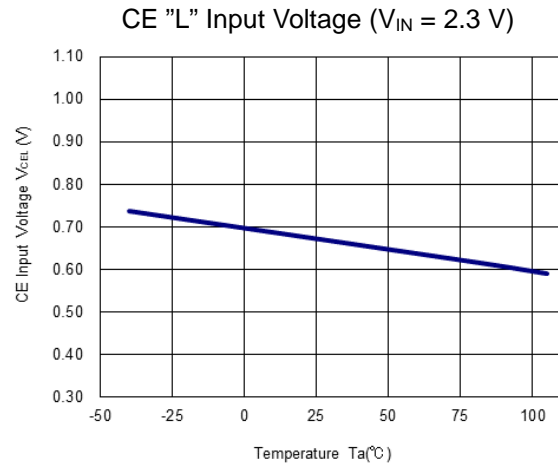
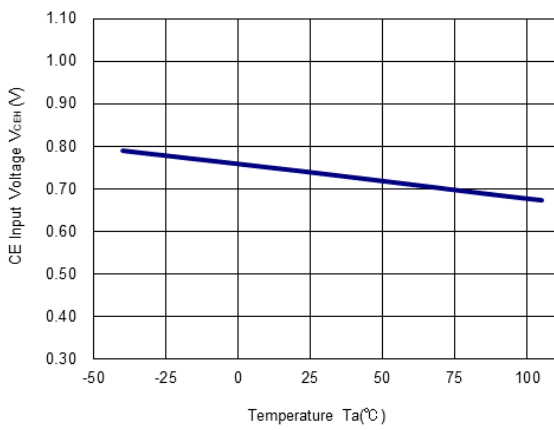

13) LX Limit Current vs. Ambient Temperature

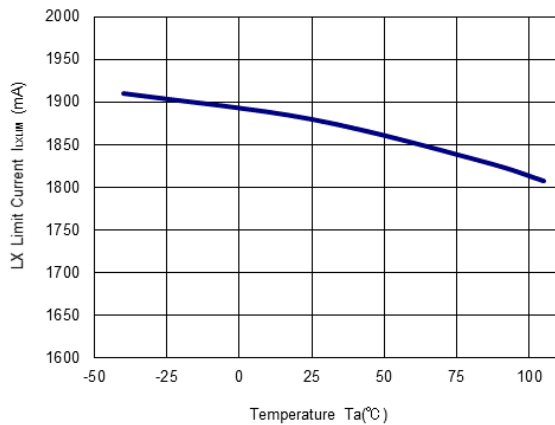

# RP550L001B

NO.EC-285-170906

14) Nch. Transistor ON Resistance vs. Ambient Temperature

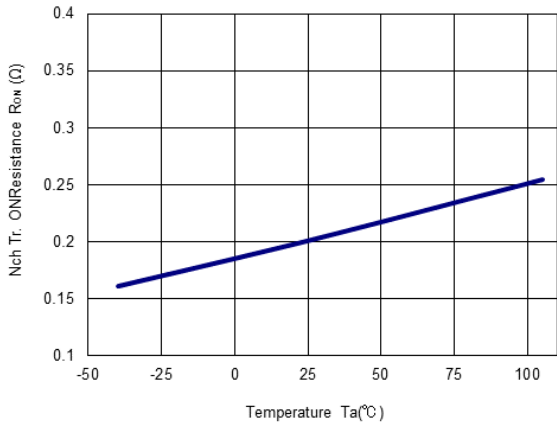

15) Pch. Transistor ON Resistance vs. Ambient Temperature

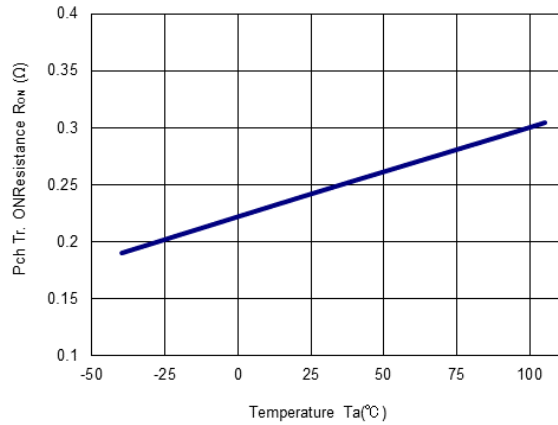

16) Load Transient Response  
RP550L001B (V<sub>IN</sub> = 3.6 V, V<sub>OUT</sub> = 0.6 V)  
MODE = "L", PWM/VFM Auto-Switching Control

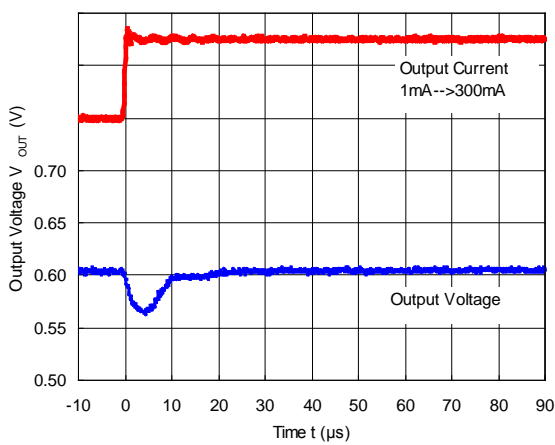

RP550L001B (V<sub>IN</sub> = 3.6 V, V<sub>OUT</sub> = 0.6 V)  
MODE = "L", PWM/VFM Auto-Switching Control

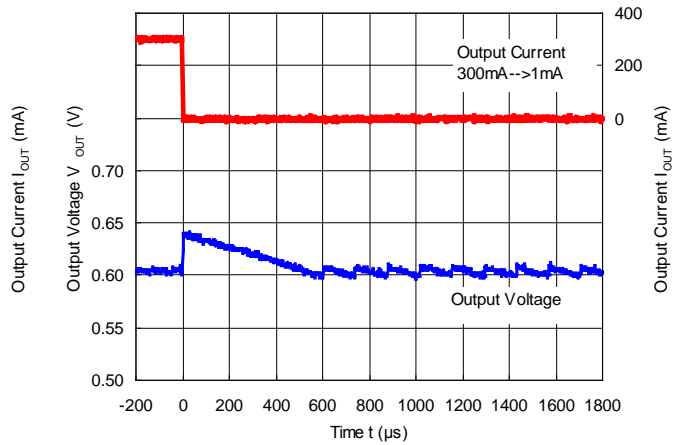

RP550L001B (V<sub>IN</sub> = 3.6 V, V<sub>OUT</sub> = 0.6 V)  
MODE = "H", Forced PWM Control

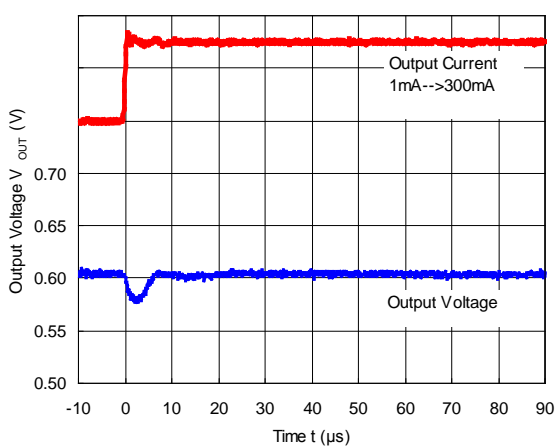

RP550L001B (V<sub>IN</sub> = 3.6 V, V<sub>OUT</sub> = 0.6 V)  
MODE = "H", Forced PWM Control

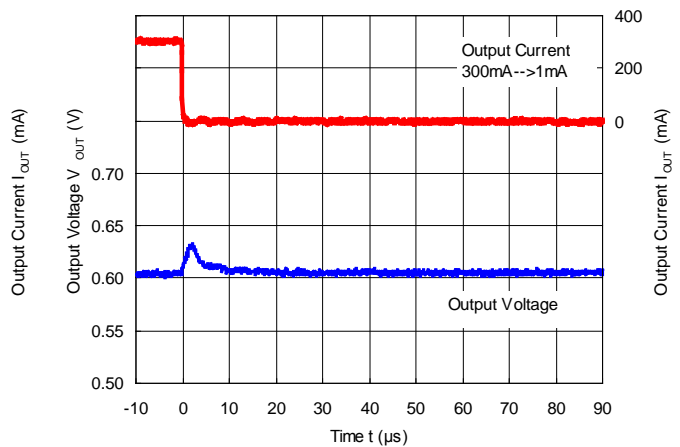

RP550L001B ( $V_{IN} = 3.6\text{ V}$ ,  $V_{OUT} = 0.6\text{ V}$ )

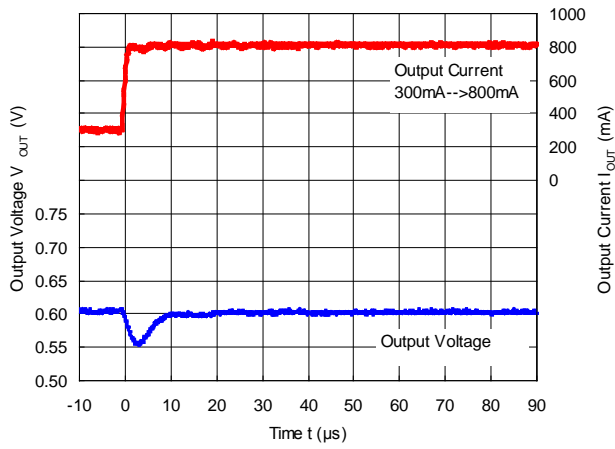

RP550L001B ( $V_{IN} = 3.6\text{ V}$ ,  $V_{OUT} = 0.6\text{ V}$ )

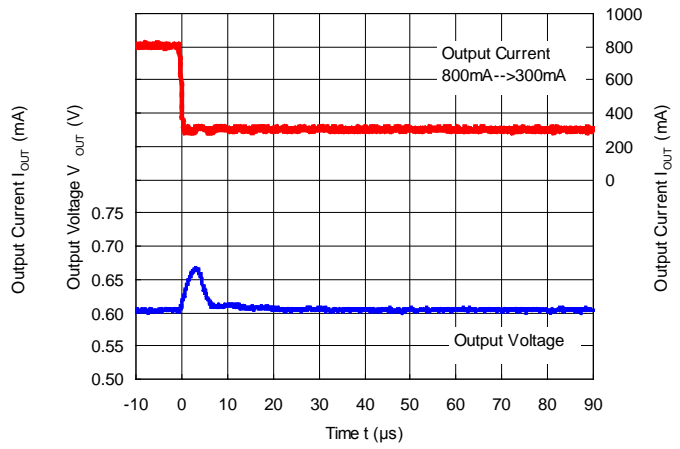

RP550L001B ( $V_{IN} = 3.6\text{ V}$ ,  $V_{OUT} = 0.8\text{ V}$ )  
MODE = "L", PWM/VFM Auto-Switching Control

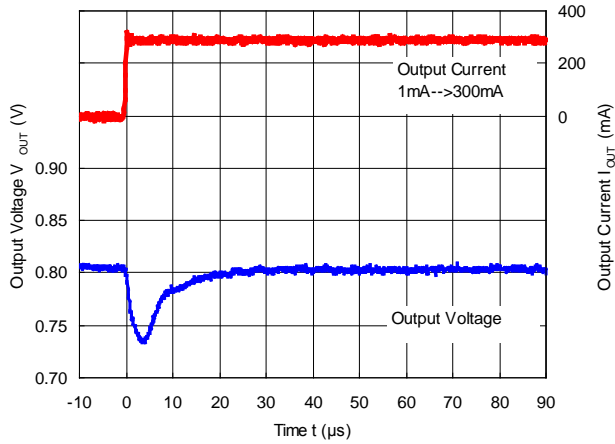

RP550L001B ( $V_{IN} = 3.6\text{ V}$ ,  $V_{OUT} = 0.8\text{ V}$ )  
MODE = "L", PWM/VFM Auto-Switching Control

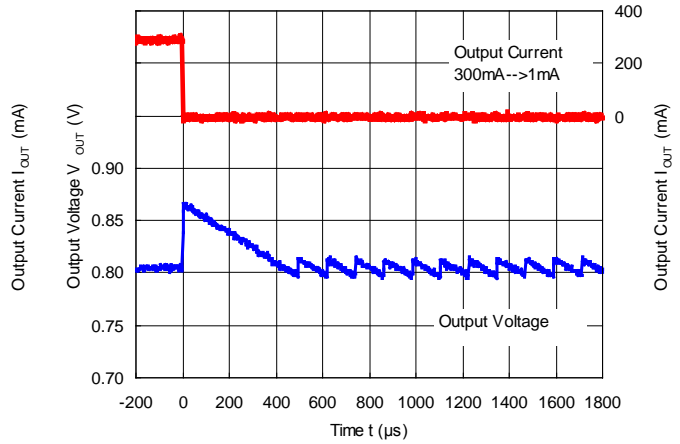

RP550L001B ( $V_{IN} = 3.6\text{ V}$ ,  $V_{OUT} = 0.8\text{ V}$ )  
MODE = "H", Forced PWM Control

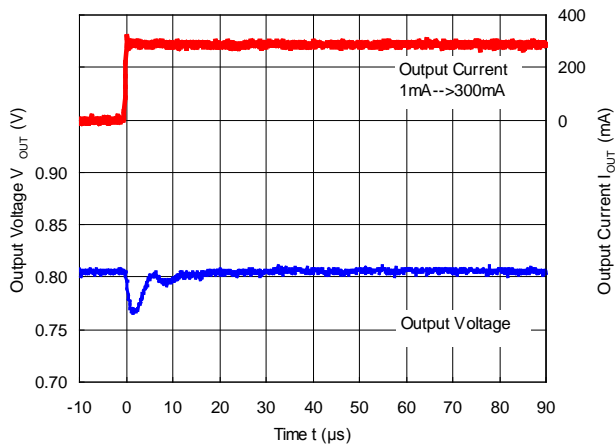

RP550L001B ( $V_{IN} = 3.6\text{ V}$ ,  $V_{OUT} = 0.8\text{ V}$ )  
MODE = "H", Forced PWM Control

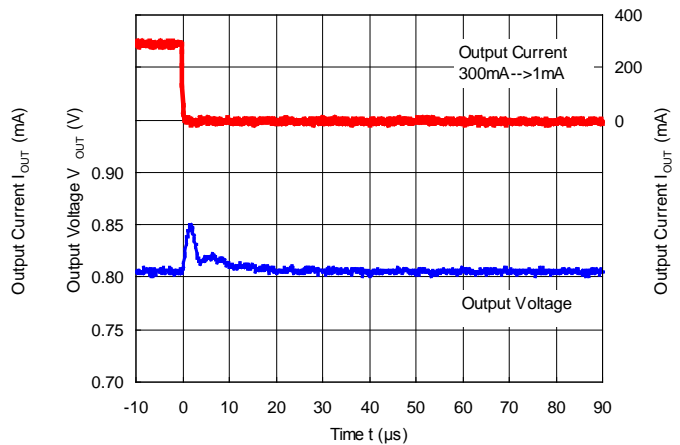

# RP550L001B

NO.EC-285-170906

RP550L001B ( $V_{IN} = 3.6\text{ V}$ ,  $V_{OUT} = 0.8\text{ V}$ )

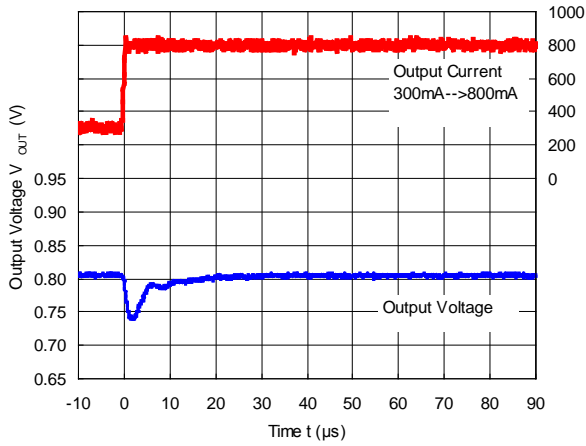

RP550L001B ( $V_{IN} = 3.6\text{ V}$ ,  $V_{OUT} = 0.8\text{ V}$ )

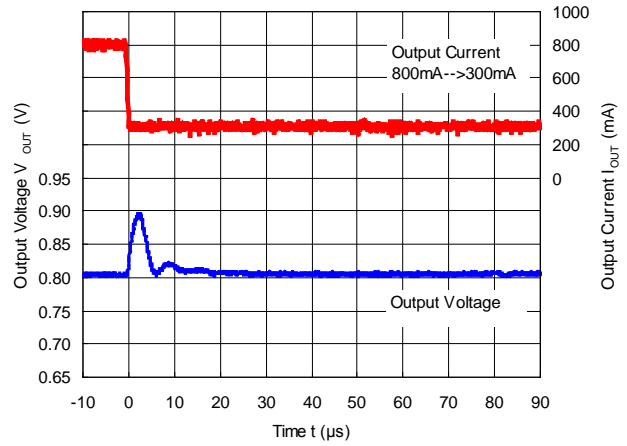

RP550L001B ( $V_{IN} = 3.6\text{ V}$ ,  $V_{OUT} = 1.2\text{ V}$ )  
MODE = "L", PWM/VFM Auto-Switching Control

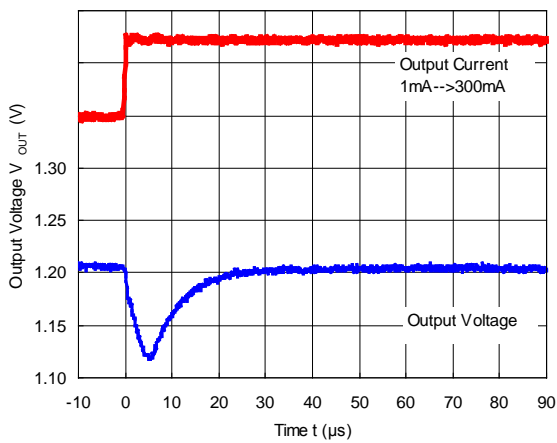

RP550L001B ( $V_{IN} = 3.6\text{ V}$ ,  $V_{OUT} = 1.2\text{ V}$ )  
MODE = "L", PWM/VFM Auto-Switching Control

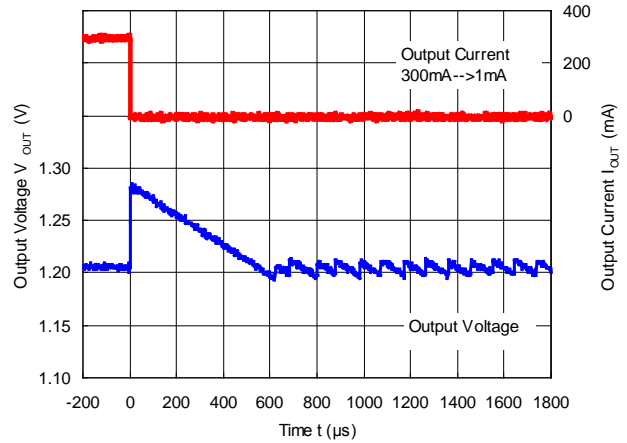

RP550L001B ( $V_{IN} = 3.6\text{ V}$ ,  $V_{OUT} = 1.2\text{ V}$ )  
MODE = "H", Forced PWM Control

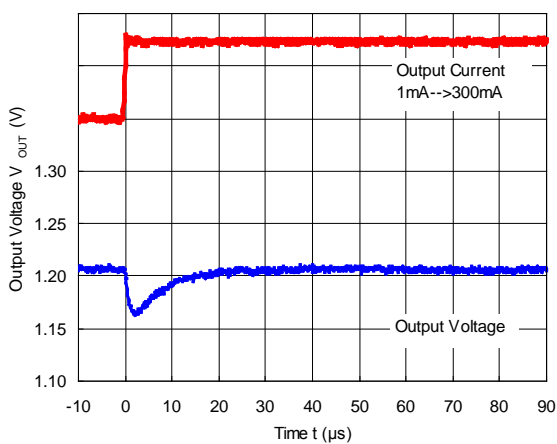

RP550L001B ( $V_{IN} = 3.6\text{ V}$ ,  $V_{OUT} = 1.2\text{ V}$ )  
MODE = "H", Forced PWM Control

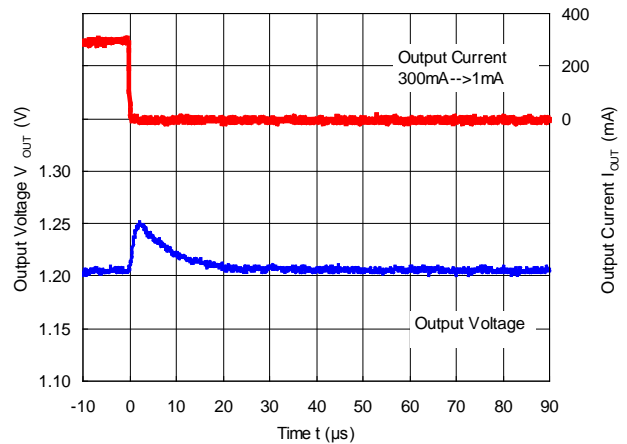

RP550L001B ( $V_{IN} = 3.6\text{ V}$ ,  $V_{OUT} = 1.2\text{ V}$ )

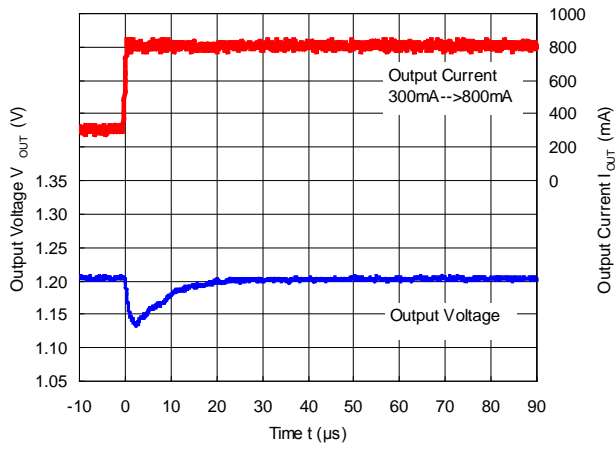

RP550L001B ( $V_{IN} = 3.6\text{ V}$ ,  $V_{OUT} = 1.2\text{ V}$ )

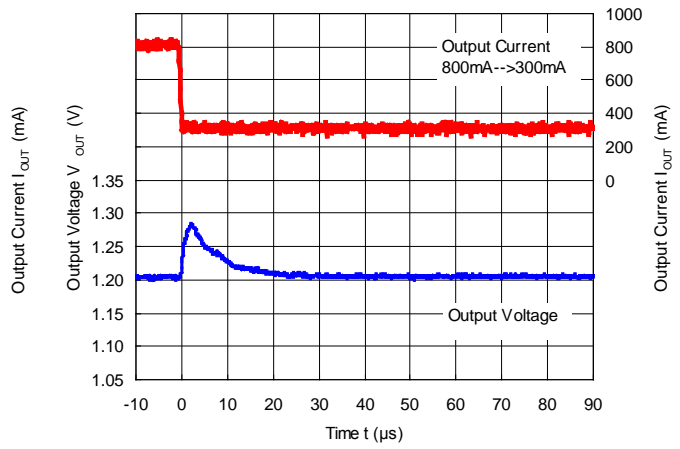

RP550L001B ( $V_{IN} = 3.6\text{ V}$ ,  $V_{OUT} = 1.8\text{ V}$ )  
MODE = "L", PWM/VFM Auto-Switching Control

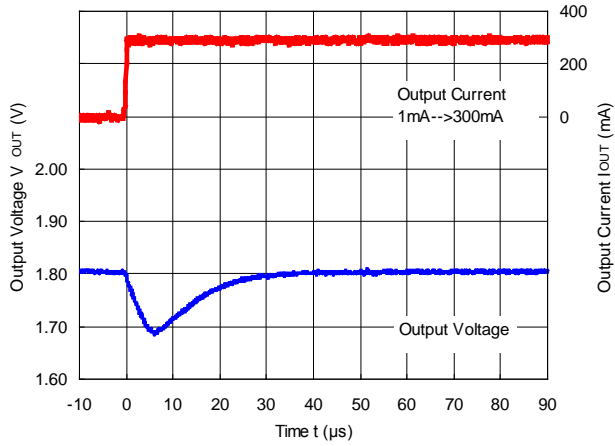

RP550L001B ( $V_{IN} = 3.6\text{ V}$ ,  $V_{OUT} = 1.8\text{ V}$ )  
MODE = "L", PWM/VFM Auto-Switching Control

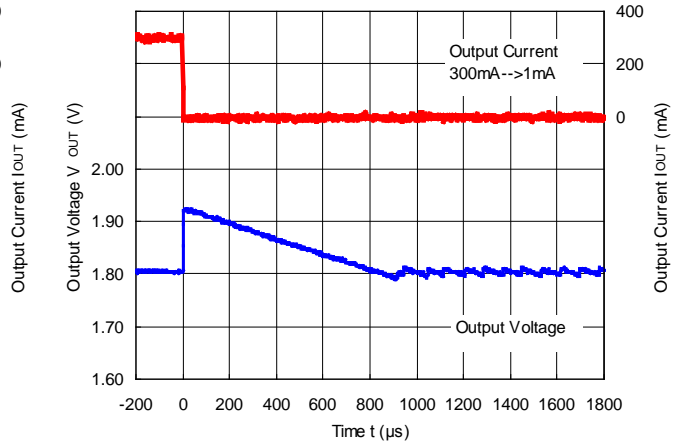

RP550L001B ( $V_{IN} = 3.6\text{ V}$ ,  $V_{OUT} = 1.8\text{ V}$ )  
MODE = "H", Forced PWM Control

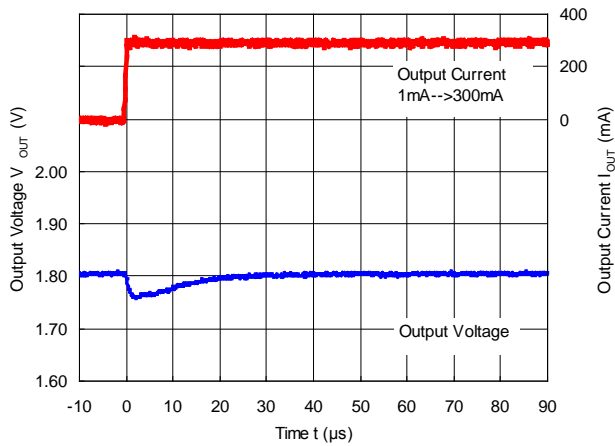

RP550L001B ( $V_{IN} = 3.6\text{ V}$ ,  $V_{OUT} = 1.8\text{ V}$ )  
MODE = "H", Forced PWM Control

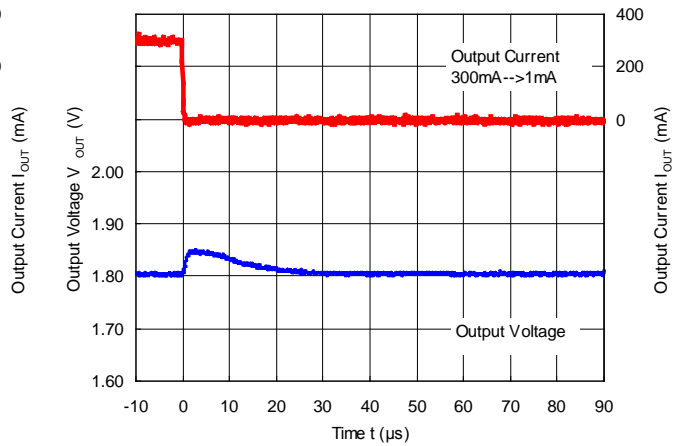

# RP550L001B

NO.EC-285-170906

RP550L001B ( $V_{IN} = 3.6\text{ V}$ ,  $V_{OUT} = 1.8\text{ V}$ )

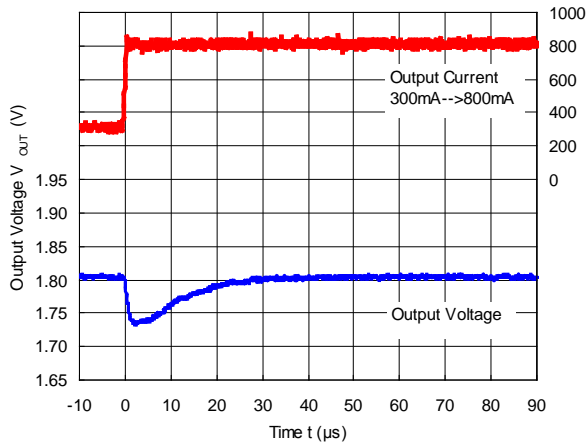

RP550L001B ( $V_{IN} = 3.6\text{ V}$ ,  $V_{OUT} = 1.8\text{ V}$ )

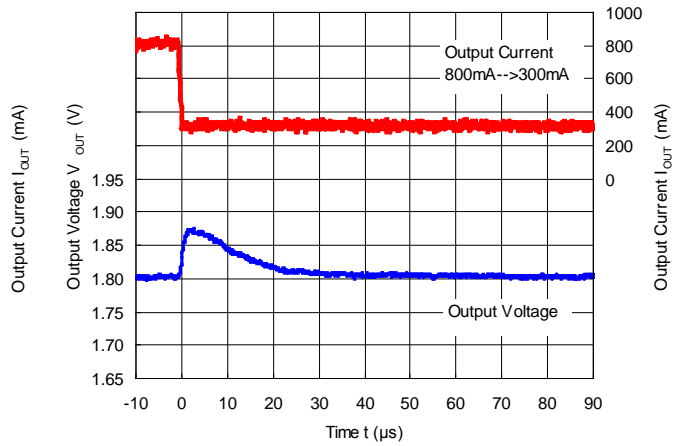

RP550L001B ( $V_{IN} = 5.0\text{ V}$ ,  $V_{OUT} = 3.3\text{ V}$ )  
MODE = "L", PWM/VFM Auto-Switching Control

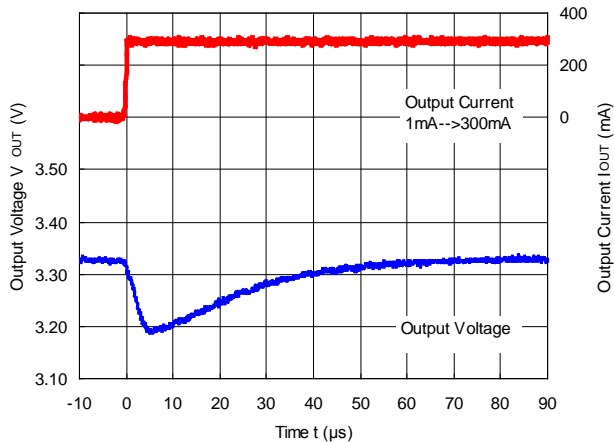

RP550L001B ( $V_{IN} = 5.0\text{ V}$ ,  $V_{OUT} = 3.3\text{ V}$ )  
MODE = "L", PWM/VFM Auto-Switching Control

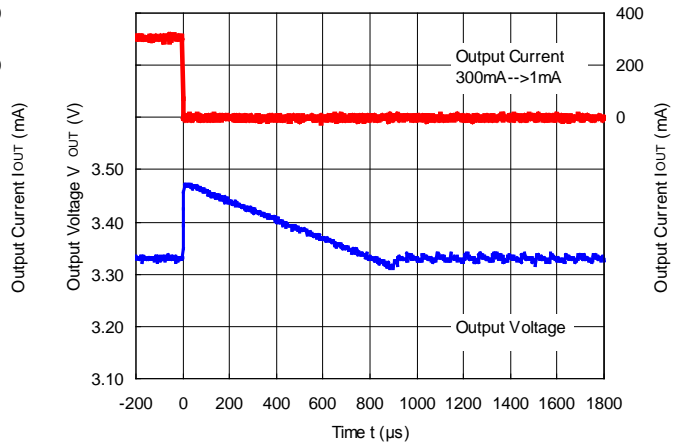

RP550L001B ( $V_{IN} = 5.0\text{ V}$ ,  $V_{OUT} = 3.3\text{ V}$ )  
MODE = "H", Forced PWM Control

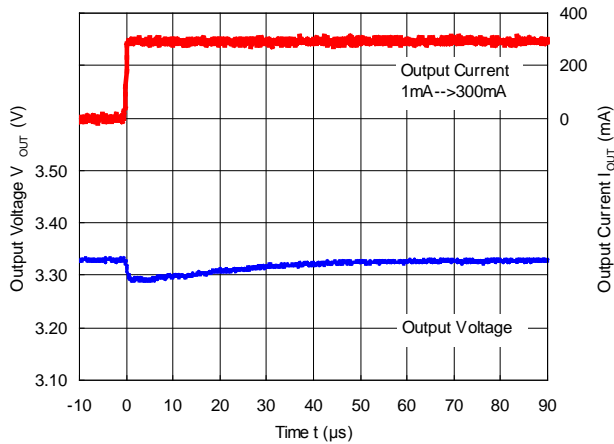

RP550L001B ( $V_{IN} = 5.0\text{ V}$ ,  $V_{OUT} = 3.3\text{ V}$ )  
MODE = "H", Forced PWM Control

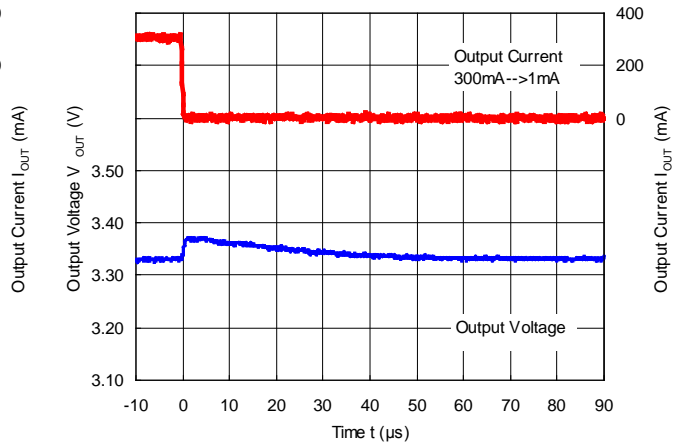

RP550L001B ( $V_{IN} = 5.0\text{ V}$ ,  $V_{OUT} = 3.3\text{ V}$ )

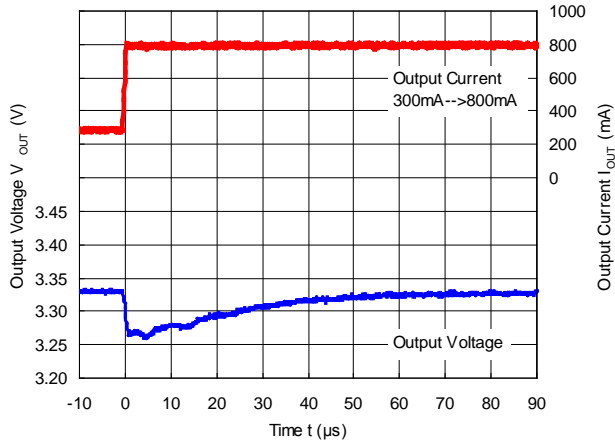

RP550L001B ( $V_{IN} = 5.0\text{ V}$ ,  $V_{OUT} = 3.3\text{ V}$ )

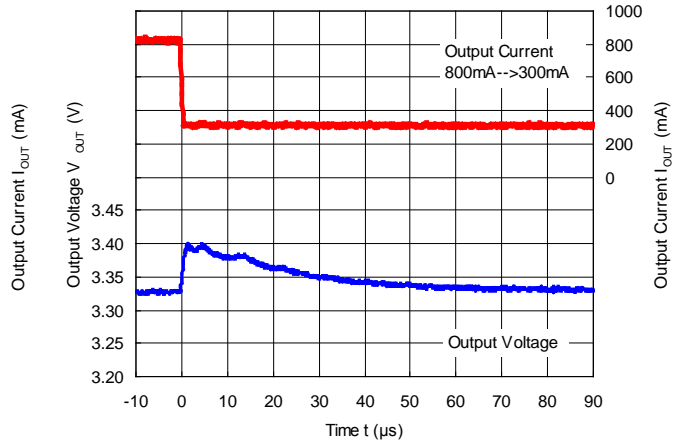

17) Mode Switching

RP550L001B ( $V_{IN} = 3.6\text{ V}$ ,  $V_{OUT} = 1.2\text{ V}$ ,  $I_{OUT} = 1\text{ mA}$ )  
MODE = "L" → MODE = "H"

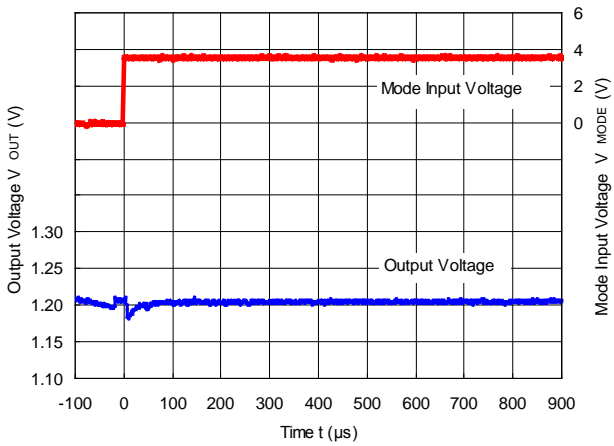

RP550L001B ( $V_{IN} = 3.6\text{ V}$ ,  $V_{OUT} = 1.2\text{ V}$ ,  $I_{OUT} = 1\text{ mA}$ )  
MODE = "H" → MODE = "L"

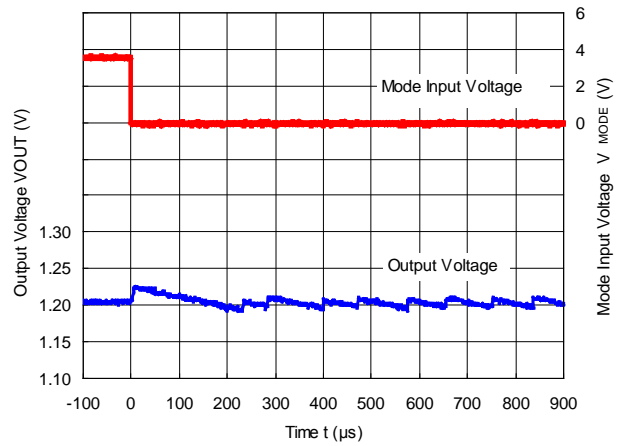

RP550L001B ( $V_{IN} = 3.6\text{ V}$ ,  $V_{OUT} = 1.8\text{ V}$ ,  $I_{OUT} = 1\text{ mA}$ )  
MODE = "L" → MODE = "H"

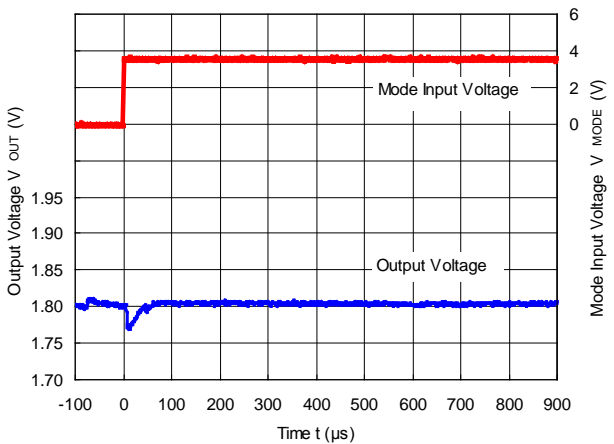

RP550L001B ( $V_{IN} = 3.6\text{ V}$ ,  $V_{OUT} = 1.8\text{ V}$ ,  $I_{OUT} = 1\text{ mA}$ )  
MODE = "H" → MODE = "L"

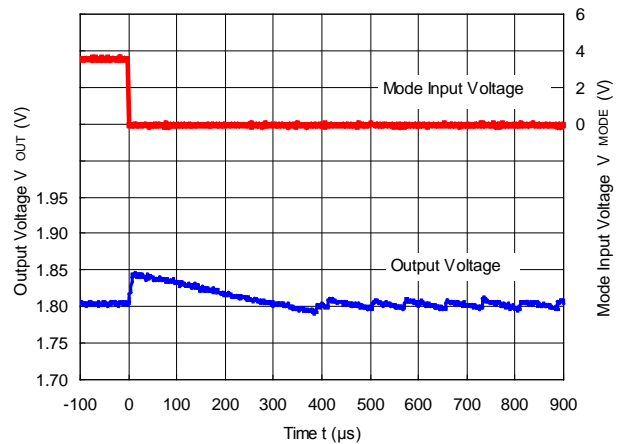

The power dissipation of the package is dependent on PCB material, layout, and environmental conditions. The following conditions are used in this measurement.

**Measurement Conditions**

	<b>Standard Test Land Pattern</b>	<b>JEDEC STD.51-7 Test Land Pattern</b>
Environment	Mounting on Board (Wind Velocity=0m/s)	Mounting on Board (Wind Velocity = 0 m/s)
Board Material	Glass cloth epoxy plastic (Double sided)	Glass Cloth Epoxy Plastic (Four-Layer Board)
Board Dimensions	40mm x 40mm x 1.6mm	76.2 mm x 114.3 mm x 1.6 mm
Copper Ratio	Top side: Approx. 50%, Back side: Approx. 50%	Outer Layers (First and Fourth Layers): Less than 10% of 60 mm Square Inner Layers (Second and Third Layers): 100% of 74.2 mm Square
Through-holes	f 0.54mm x 32pcs	f 0.85 mm x 64 pcs * The land pattern of Tab (Heat spreader), the inner layers and the backside pattern are connected by 0.3mm through-hole.

**Measurement Result**

(Ta = 25°C, Tjmax = 150°C)

	<b>Standard Test Land Pattern</b>	<b>JEDEC STD.51-7 Test Land Pattern</b>
Power Dissipation	1250mW	2440 mW
Thermal Resistance	$q_{ja} = (150-25^{\circ}\text{C})/1.25\text{W} = 100^{\circ}\text{C/W}$ $q_{jc} = 18^{\circ}\text{C/W}$	$q_{ja} = (150 - 25^{\circ}\text{C}) / 2.44 \text{ W} = 51.2^{\circ}\text{C/W}$ $q_{jc} = 5.9^{\circ}\text{C/W}$

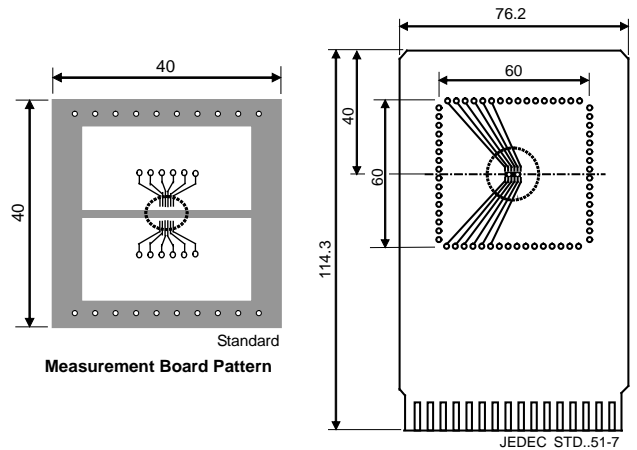
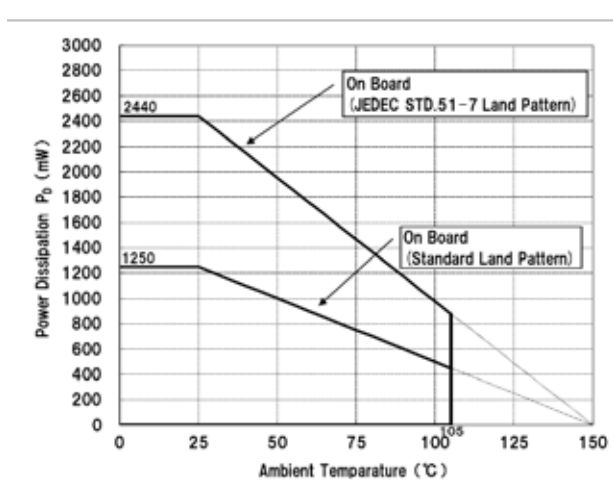

IC Mount Area (mm)

**Power Dissipation vs. Ambient Temperature**

**Measurement Board Pattern**



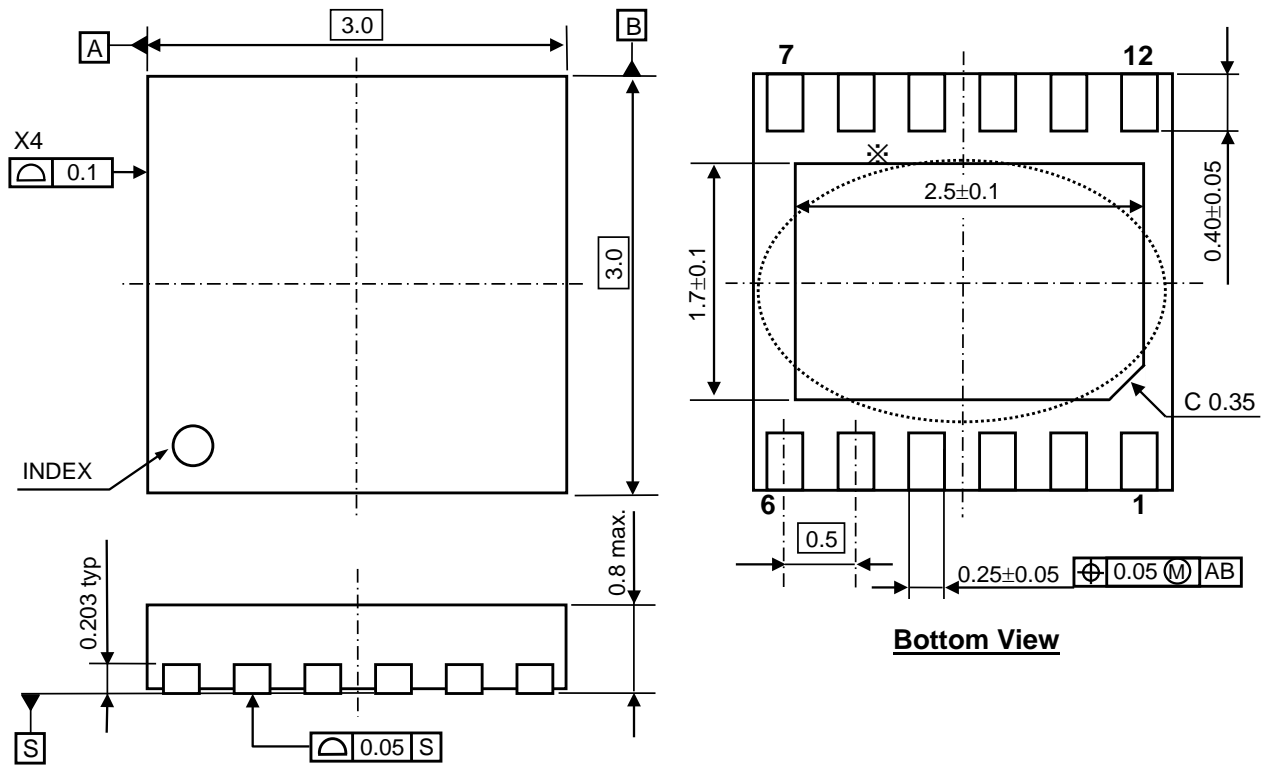

DFN3030-12 Package Dimensions (Unit: mm)

\* The tab on the bottom of the package is substrate level (GND). It is recommended that the tab be connected to the ground plane on the board, or otherwise be left floating.



1. The products and the product specifications described in this document are subject to change or discontinuation of production without notice for reasons such as improvement. Therefore, before deciding to use the products, please refer to our sales representatives for the latest information thereon.
2. The materials in this document may not be copied or otherwise reproduced in whole or in part without prior written consent of our company.
3. Please be sure to take any necessary formalities under relevant laws or regulations before exporting or otherwise taking out of your country the products or the technical information described herein.
4. The technical information described in this document shows typical characteristics of and example application circuits for the products. The release of such information is not to be construed as a warranty of or a grant of license under our company's or any third party's intellectual property rights or any other rights.
5. The products in this document are designed for automotive applications. However, when using the products for automotive applications, please make sure to contact our sales representative in advance due to confirming the quality level.
6. We are making our continuous effort to improve the quality and reliability of our products, but semiconductor products are likely to fail with certain probability. In order to prevent any injury to persons or damages to property resulting from such failure, customers should be careful enough to incorporate safety measures in their design, such as redundancy feature, fire containment feature and fail-safe feature. We do not assume any liability or responsibility for any loss or damage arising from misuse or inappropriate use of the products.
7. Anti-radiation design is not implemented in the products described in this document.
8. The X-ray exposure can influence functions and characteristics of the products. Confirm the product functions and characteristics in the evaluation stage.
9. WLCSP products should be used in light shielded environments. The light exposure can influence functions and characteristics of the products under operation or storage.
10. There can be variation in the marking when different AOI (Automated Optical Inspection) equipment is used. In the case of recognizing the marking characteristic with AOI, please contact our sales or our distributor before attempting to use AOI.
11. Please contact our sales representatives should you have any questions or comments concerning the products or the technical information.



**Nisshinbo Micro Devices Inc.**

**Official website**

<https://www.nisshinbo-microdevices.co.jp/en/>

**Purchase information**

<https://www.nisshinbo-microdevices.co.jp/en/buy/>

