

300 mA Small Dual LDO Regulator for Industrial Applications

No. EY-202-230523

OUTLINE

The RP154x is a voltage regulator that provides high ripple rejection, low dropout voltage, high output voltage accuracy, and low supply current. The RP154x consists of a voltage reference unit, an error amplifier, resistors for setting output voltage, a short current limit circuit, and a chip enable circuit.

The RP154x is available in fixed output voltage options. Besides the low supply current by CMOS, the RP154x offers a low dropout voltage by built-in low ON resistance T_r as well as an extended battery life by a chip enable function. Compared with the existing CMOS-based regulators, the RP154x is further improved in ripple rejection, line transient response, and load transient response.

The RP154x is offered in a 6-pin SOT-23-6 package for a single input type, and an 8-pin DFN2020-8 package and an 8-pin DFN1216-8 package for a dual input type. Each package is equipped with two LDOs which can achieve high-density mounting.

This is a high-reliability semiconductor device for industrial applications (-Y) that has passed both the screening at high temperature and the reliability test with extended hours.

FEATURES

- Input Voltage Range (Maximum Rating) 1.4 V to 5.25 V (6.0 V)
- Operating Temperature Range -40°C to 105°C
- Supply Current..... Typ. $50\ \mu\text{A} \times 2$ (VR1 & VR2)
- Standby Current..... Typ. $0.1\ \mu\text{A} \times 2$ (VR1 & VR2)
- Output Voltage Range 0.8 V to 3.7 V (0.1 V step)
- Output Voltage Accuracy $\pm 1.0\%$ ($V_{\text{SET}} > 2.0\ \text{V}$, $T_a = 25^{\circ}\text{C}$)
- Temperature-Drift Coefficient of Output Voltage..... Typ. $\pm 80\ \text{ppm}/^{\circ}\text{C}$
- Dropout Voltage Typ. 0.25 V ($I_{\text{OUT}} = 300\ \text{mA}$, $V_{\text{SET}} = 2.5\ \text{V}$)
- Ripple Rejection..... Typ. 75 dB ($f = 1\ \text{kHz}$)
- Line Regulation..... Typ. 0.02%/V
- Output Noise Typ. $75\ \mu\text{V}_{\text{rms}}$ (BW = 10 Hz to 100 kHz)
- Short-current Limit Circuit..... Typ. 60 mA
- Overcurrent Protection Circuit
- Ceramic Capacitor Compatible..... 1.0 μF or more
- Packages DFN2020-8, SOT-23-6, DFN1216-8

APPLICATIONS

- Industrial equipments such as FAs and smart meters
- Equipments used under high-temperature conditions such as surveillance camera and vending machine
- Equipments accompanied by self-heating such as motor and lighting

SELECTION GUIDE

The set output voltage, the package, and the auto-discharge function⁽¹⁾ are user-selectable options.

Selection Guide

Product Name	Package	Quantity per Reel	Pb Free	Halogen Free
RP154L5xx*-TR-Y	DFN2020-8	3,000 pcs	Yes	Yes
RP154N0xx*-TR-YE	SOT-23-6	3,000 pcs	Yes	Yes
RP154L0xx*-E2-Y	DFN1216-8	5,000 pcs	Yes	Yes

5xx: The combination of set output voltage for each channel can be designated by serial numbers (from 501). The set output voltage for each channel can be set in the range from 0.8 V to 3.7 V in 0.1 V step.

0xx: The combination of set output voltage for each channel can be designated by serial numbers (from 001). The set output voltage for each channel can be set in the range from 0.8 V to 3.7 V in 0.1 V step.

*: The auto-discharge function at off state are options as follows.

(A) Auto-discharge function not included, Active-high

(B) Auto-discharge function included, Active-high

⁽¹⁾ Auto-discharge function quickly lowers the output voltage to 0 V by releasing the electrical charge accumulated in the external capacitor when the chip enable signal is switched from the active mode to the standby mode.

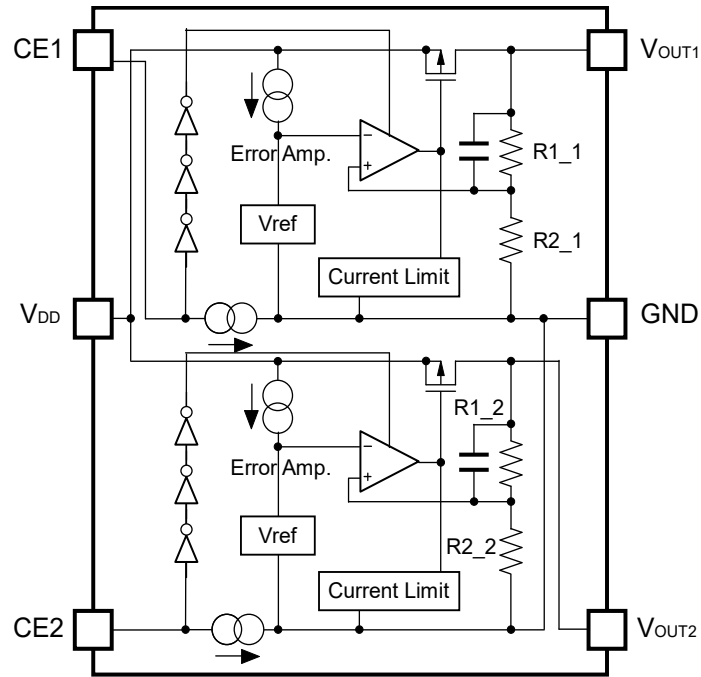

RP154NxxxA Block Diagram

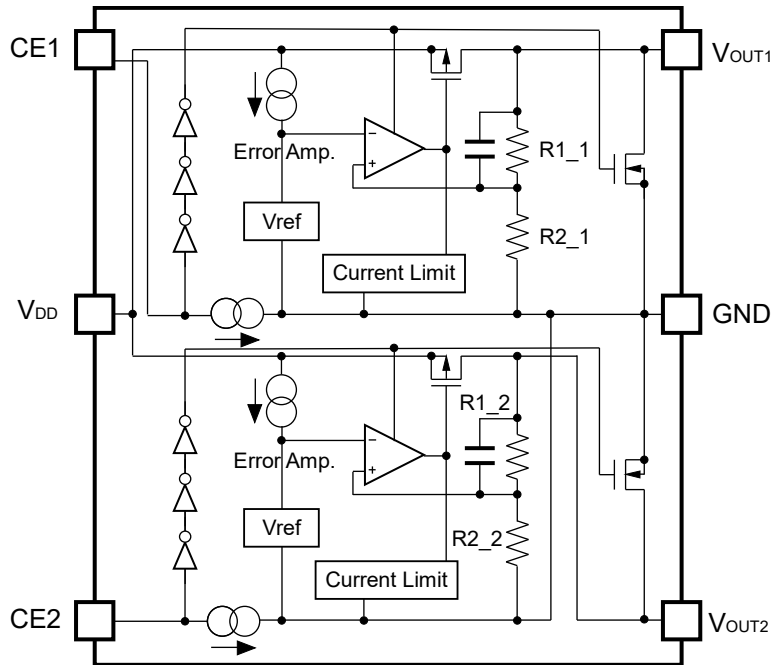

RP154NxxxB Block Diagram

PIN DESCRIPTIONS

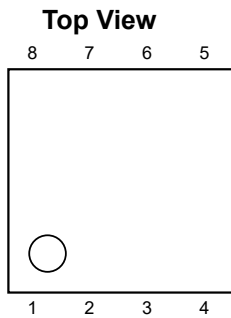

DFN2020-8 Pin Configuration

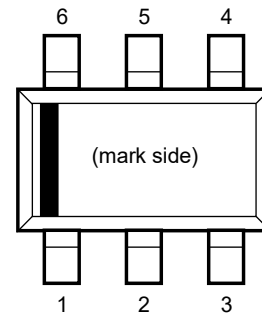
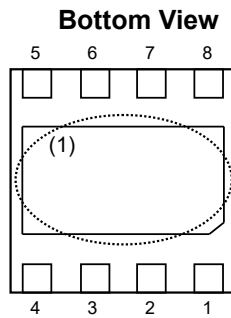

SOT-23-6 Pin Configuration

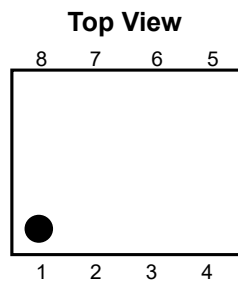

DFN1216-8 Pin Configuration

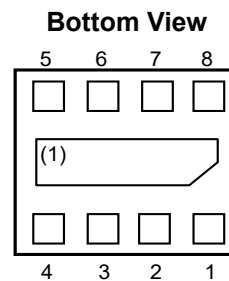

DFN2020-8 Pin Description

Pin No.	Symbol	Description
1	GND	Ground Pin ⁽²⁾
2	VOUT1	Output Pin 1
3	VOUT2	Output Pin 2
4	GND	Ground Pin ⁽²⁾
5	CE2	Chip Enable Pin 2, Active-high
6	VDD2	Input Pin 2
7	VDD1	Input Pin 1
8	CE1	Chip Enable Pin 1, Active-high

⁽¹⁾ Tab is GND level. (They are connected to the reverse side of this IC). The tab is better to be connected to the GND, but leaving it open is also acceptable.

⁽²⁾ The GND pin must be wired together when it is mounted on board.

SOT-23-6 Pin Description

Pin No.	Symbol	Description
1	CE1	Chip Enable Pin 1, Active-high
2	VDD	Input Pin
3	CE2	Chip Enable Pin 2, Active-high
4	VOUT2	Output Pin 2
5	GND	Ground Pin
6	VOUT1	Output Pin 1

DFN1216-8 Pin Description

Pin No.	Symbol	Description
1	GND	Ground Pin ⁽¹⁾
2	VOUT1	Output Pin 1
3	VOUT2	Output Pin 2
4	GND	Ground Pin ⁽¹⁾
5	CE2	Chip Enable Pin 2, Active-high
6	VDD2	Input Pin 2
7	VDD1	Input Pin 1
8	CE1	Chip Enable Pin 1, Active-high

⁽¹⁾ The GND pin must be wired together when it is mounted on board.

ABSOLUTE MAXIMUM RATINGS

Absolute Maximum Ratings

Symbol	Item	Rating	Unit
V_{IN}	Input Voltage	6.0	V
V_{CE}	Input Voltage (CE Pin)	-0.3 to 6.0	V
V_{OUT1}, V_{OUT2}	Output Voltage	-0.3 to $V_{IN} + 0.3$	V
I_{OUT1}, I_{OUT2}	Output Current	400	mA
P_D	Power Dissipation ⁽¹⁾ (JEDEC STD. 51-7 Test Land Pattern)	DFN2020-8	3100
		SOT-23-6	830
		DFN1216-8	2200
T_j	Junction Temperature Range	-40 to 150	°C
T_{stg}	Storage Temperature Range	-55 to 150	°C

ABSOLUTE MAXIMUM RATINGS

Electronic and mechanical stress momentarily exceeded absolute maximum ratings may cause permanent damage and may degrade the life time and safety for both device and system using the device in the field. The functional operation at or over these absolute maximum ratings is not assured.

RECOMMENDED OPERATING CONDITIONS

Recommended Operating Conditions

Symbol	Item	Rating	Unit
V_{IN}	Input Voltage	1.4 to 5.25	V
T_a	Operating Temperature Range	-40 to 105	°C

RECOMMENDED OPERATING CONDITIONS

All of electronic equipment should be designed that the mounted semiconductor devices operate within the recommended operating conditions. The semiconductor devices cannot operate normally over the recommended operating conditions, even if they are used over such conditions by momentary electronic noise or surge. And the semiconductor devices may receive serious damage when they continue to operate over the recommended operating conditions.

⁽¹⁾ Refer to *POWER DISSIPATION* for detailed information.

ELECTRICAL CHARACTERISTICS

$V_{IN} = V_{SET} + 1.0\text{ V}$ ($V_{SET} > 1.5\text{ V}$), $V_{IN} = 2.5\text{ V}$ ($V_{SET} \leq 1.5\text{ V}$), $I_{OUT} = 1\text{ mA}$, $C_{IN} = C_{OUT} = 1.0\text{ }\mu\text{F}$, unless otherwise noted, V_{SET} is Set Output Voltage.

The specification in is checked and guaranteed by design engineering at $-40^{\circ}\text{C} \leq T_a \leq 105^{\circ}\text{C}$.

VR1/VR2 Electrical Characteristics

($T_a = 25^{\circ}\text{C}$)

Symbol	Item	Conditions	Min.	Typ.	Max.	Unit	
V_{OUT}	Output Voltage	$T_a = 25^{\circ}\text{C}$	$V_{SET} > 2.0\text{ V}$	x0.99		x1.01	V
			$V_{SET} \leq 2.0\text{ V}$	-20		20	mV
		$-40^{\circ}\text{C} \leq T_a \leq 105^{\circ}\text{C}$	$V_{SET} > 2.0\text{ V}$	x0.964		x1.03	V
			$V_{SET} \leq 2.0\text{ V}$	-72		60	mV
I_{LIM}	Output Current Limit		300			mA	
$\Delta V_{OUT}/\Delta I_{OUT}$	Load Regulation	$1\text{ mA} \leq I_{OUT} \leq 300\text{ mA}$		15	40	mV	
V_{DIF}	Dropout Voltage	Refer to <i>Dropout Voltage by Set Output Voltage</i> .					
I_{SS}	Supply Current	$I_{OUT} = 0\text{ mA}$		50	90	μA	
$I_{standby}$	Standby Current	$V_{CE} = 0\text{ V}$		0.1	4.5	μA	
$\Delta V_{OUT}/\Delta V_{IN}$	Line Regulation	$V_{SET} + 0.5\text{ V} \leq V_{IN} \leq 5.25\text{ V}$ ($V_{IN} \geq 1.4\text{ V}$)		0.02	0.10	%/V	
I_{SC}	Short Current	$V_{OUT} = 0\text{ V}$		60	120	mA	
I_{PD}	CE Pull-down Current			0.3	0.6	μA	
V_{CEH}	CE Input Voltage "H"		1.0			V	
V_{CEL}	CE Input Voltage "L"				0.4	V	
R_{LOW}	Low Output Nch Tr. ON Resistance (of B version)	$V_{IN} = 4.0\text{ V}$, $V_{CE} = 0\text{ V}$		50		Ω	

Dropout Voltage by Set Output Voltage

($T_a = 25^{\circ}\text{C}$)

Set Output Voltage V_{SET} (V)	Dropout Voltage V_{DIF} (V)		
	Condition	Typ.	Max.
$V_{SET} = 0.8$	$I_{OUT} = 300\text{ mA}$	0.56	0.74
$V_{SET} = 0.9$		0.51	0.67
$1.0 \leq V_{SET} < 1.2$		0.46	0.61
$1.2 \leq V_{SET} < 1.4$		0.39	0.52
$1.4 \leq V_{SET} < 1.7$		0.35	0.46
$1.7 \leq V_{SET} < 2.1$		0.30	0.41
$2.1 \leq V_{SET} < 2.5$		0.26	0.36
$2.5 \leq V_{SET} < 3.0$		0.25	0.32
$3.0 \leq V_{SET} \leq 3.7$		0.22	0.31

RP154L5xxx Product-specific Electrical Characteristics

Product Name	VR1								VR2							
	V _{OUT} [V] (T _a = 25°C)			V _{OUT} [V] (-40°C ≤ T _a ≤ 105°C)			ΔV _{DIF} [V]		V _{OUT} [V] (T _a = 25°C)			V _{OUT} [V] (-40°C ≤ T _a ≤ 105°C)			ΔV _{DIF} [V]	
	Min.	Typ.	Max.	Min.	Typ.	Max.	Typ.	Max.	Min.	Typ.	Max.	Min.	Typ.	Max.	Typ.	Max.
RP154L502x	1.780	1.800	1.820	1.728	1.800	1.860	0.30	0.41	2.772	2.800	2.828	2.700	2.800	2.884	0.25	0.32
RP154L504x	1.180	1.200	1.220	1.128	1.200	1.260	0.39	0.52	1.780	1.800	1.820	1.728	1.800	1.860	0.30	0.41
RP154L505x	3.267	3.300	3.333	3.182	3.300	3.399	0.22	0.31	1.180	1.200	1.220	1.128	1.200	1.260	0.39	0.52
RP154L506x	3.267	3.300	3.333	3.182	3.300	3.399	0.22	0.31	1.780	1.800	1.820	1.728	1.800	1.860	0.30	0.41
RP154L510x	2.970	3.000	3.030	2.892	3.000	3.090	0.22	0.31	1.780	1.800	1.820	1.728	1.800	1.860	0.30	0.41
RP154L513x	3.267	3.300	3.333	3.182	3.300	3.399	0.22	0.31	2.772	2.800	2.828	2.700	2.800	2.884	0.25	0.32
RP154L514x	3.267	3.300	3.333	3.182	3.300	3.399	0.22	0.31	3.267	3.300	3.333	3.182	3.300	3.399	0.22	0.31
RP154L518x	1.780	1.800	1.820	1.728	1.800	1.860	0.30	0.41	1.780	1.800	1.820	1.728	1.800	1.860	0.30	0.41
RP154L521x	1.180	1.200	1.220	1.128	1.200	1.260	0.39	0.52	2.772	2.800	2.828	2.700	2.800	2.884	0.25	0.32
RP154L524x	3.267	3.300	3.333	3.182	3.300	3.399	0.22	0.31	2.970	3.000	3.030	2.892	3.000	3.090	0.22	0.31
RP154L525x	2.970	3.000	3.030	2.892	3.000	3.090	0.22	0.31	2.970	3.000	3.030	2.892	3.000	3.090	0.22	0.31
RP154L533x	1.780	1.800	1.820	1.728	1.800	1.860	0.30	0.41	2.871	2.900	2.929	2.796	2.900	2.987	0.25	0.32
RP154L536x	0.980	1.000	1.020	0.928	1.000	1.060	0.46	0.61	1.780	1.800	1.820	1.728	1.800	1.860	0.30	0.41
RP154L537x	1.180	1.200	1.220	1.128	1.200	1.260	0.39	0.52	2.475	2.500	2.525	2.410	2.500	2.575	0.25	0.32
RP154L539x	1.780	1.800	1.820	1.728	1.800	1.860	0.30	0.41	2.475	2.500	2.525	2.410	2.500	2.575	0.25	0.32
RP154L552x	1.780	1.800	1.820	1.728	1.800	1.860	0.30	0.41	2.970	3.000	3.030	2.892	3.000	3.090	0.22	0.31
RP154L554x	1.180	1.200	1.220	1.128	1.200	1.260	0.39	0.52	1.180	1.200	1.220	1.128	1.200	1.260	0.39	0.52
RP154L561x	1.180	1.200	1.220	1.128	1.200	1.260	0.39	0.52	2.970	3.000	3.030	2.892	3.000	3.090	0.22	0.31
RP154L562x	2.772	2.800	2.828	2.700	2.800	2.884	0.25	0.32	2.871	2.900	2.929	2.796	2.900	2.987	0.25	0.32
RP154L563x	3.267	3.300	3.333	3.182	3.300	3.399	0.22	0.31	1.480	1.500	1.520	1.428	1.500	1.560	0.35	0.46
RP154L564x	1.080	1.100	1.120	1.028	1.100	1.160	0.46	0.61	2.871	2.900	2.929	2.796	2.900	2.987	0.25	0.32
RP154L565x	2.772	2.800	2.828	2.700	2.800	2.884	0.25	0.32	2.475	2.500	2.525	2.410	2.500	2.575	0.25	0.32
RP154L566x	0.780	0.800	0.820	0.728	0.800	0.860	0.56	0.74	1.780	1.800	1.820	1.728	1.800	1.860	0.30	0.41
RP154L567x	3.267	3.300	3.333	3.182	3.300	3.399	0.22	0.31	2.475	2.500	2.525	2.410	2.500	2.575	0.25	0.32
RP154L568x	1.280	1.300	1.320	1.228	1.300	1.360	0.39	0.52	1.780	1.800	1.820	1.728	1.800	1.860	0.30	0.41
RP154L569x	1.680	1.700	1.720	1.628	1.700	1.760	0.30	0.41	1.480	1.500	1.520	1.428	1.500	1.560	0.35	0.46
RP154L570x	1.180	1.200	1.220	1.128	1.200	1.260	0.39	0.52	1.280	1.300	1.320	1.228	1.300	1.360	0.39	0.52
RP154L571x	1.080	1.100	1.120	1.028	1.100	1.160	0.46	0.61	3.267	3.300	3.333	3.182	3.300	3.399	0.22	0.31

RP154N0xxx/RP154L0xxx Product-specific Electrical Characteristics

Product Name	VR1								VR2							
	V _{OUT} [V] (Ta = 25°C)			V _{OUT} [V] (-40°C ≤ Ta ≤ 105°C)			ΔV _{DIF} [V]		V _{OUT} [V] (Ta = 25°C)			V _{OUT} [V] (-40°C ≤ Ta ≤ 105°C)			ΔV _{DIF} [V]	
	Min.	Typ.	Max.	Min.	Typ.	Max.	Typ.	Max.	Min.	Typ.	Max.	Min.	Typ.	Max.	Typ.	Max.
RP154x001x	2.772	2.800	2.828	2.700	2.800	2.884	0.25	0.32	2.772	2.800	2.828	2.700	2.800	2.884	0.25	0.32
RP154x002x	1.780	1.800	1.820	1.728	1.800	1.860	0.30	0.41	2.772	2.800	2.828	2.700	2.800	2.884	0.25	0.32
RP154x003x	1.480	1.500	1.520	1.428	1.500	1.560	0.35	0.46	2.772	2.800	2.828	2.700	2.800	2.884	0.25	0.32
RP154x004x	1.180	1.200	1.220	1.128	1.200	1.260	0.39	0.52	1.780	1.800	1.820	1.728	1.800	1.860	0.30	0.41
RP154x005x	3.267	3.300	3.333	3.182	3.300	3.399	0.22	0.31	1.180	1.200	1.220	1.128	1.200	1.260	0.39	0.52
RP154x006x	3.267	3.300	3.333	3.182	3.300	3.399	0.22	0.31	1.780	1.800	1.820	1.728	1.800	1.860	0.30	0.41
RP154x007x	2.822	2.850	2.878	2.748	2.850	2.935	0.25	0.32	2.822	2.850	2.878	2.748	2.850	2.935	0.25	0.32
RP154x008x	2.822	2.850	2.878	2.748	2.850	2.935	0.25	0.32	2.574	2.600	2.626	2.507	2.600	2.678	0.25	0.32
RP154x009x	2.970	3.000	3.030	2.892	3.000	3.090	0.22	0.31	2.772	2.800	2.828	2.700	2.800	2.884	0.25	0.32
RP154x010x	2.970	3.000	3.030	2.892	3.000	3.090	0.22	0.31	1.780	1.800	1.820	1.728	1.800	1.860	0.30	0.41
RP154x011x	1.780	1.800	1.820	1.728	1.800	1.860	0.30	0.41	1.480	1.500	1.520	1.428	1.500	1.560	0.35	0.46
RP154x012x	2.772	2.800	2.828	2.700	2.800	2.884	0.25	0.32	2.574	2.600	2.626	2.507	2.600	2.678	0.25	0.32
RP154x013x	3.267	3.300	3.333	3.182	3.300	3.399	0.22	0.31	2.772	2.800	2.828	2.700	2.800	2.884	0.25	0.32
RP154x014x	3.267	3.300	3.333	3.182	3.300	3.399	0.22	0.31	3.267	3.300	3.333	3.182	3.300	3.399	0.22	0.31
RP154x015x	1.480	1.500	1.520	1.428	1.500	1.560	0.35	0.46	2.475	2.500	2.525	2.410	2.500	2.575	0.25	0.32
RP154x016x	1.480	1.500	1.520	1.428	1.500	1.560	0.35	0.46	2.970	3.000	3.030	2.892	3.000	3.090	0.22	0.31
RP154x017x	2.475	2.500	2.525	2.410	2.500	2.575	0.25	0.32	2.970	3.000	3.030	2.892	3.000	3.090	0.22	0.31
RP154x018x	1.780	1.800	1.820	1.728	1.800	1.860	0.30	0.41	1.780	1.800	1.820	1.728	1.800	1.860	0.30	0.41
RP154x019x	1.480	1.500	1.520	1.428	1.500	1.560	0.35	0.46	2.574	2.600	2.626	2.507	2.600	2.678	0.25	0.32
RP154x020x	2.772	2.800	2.828	2.700	2.800	2.884	0.25	0.32	1.780	1.800	1.820	1.728	1.800	1.860	0.30	0.41
RP154x021x	1.180	1.200	1.220	1.128	1.200	1.260	0.39	0.52	2.772	2.800	2.828	2.700	2.800	2.884	0.25	0.32
RP154x022x	2.772	2.800	2.828	2.700	2.800	2.884	0.25	0.32	1.180	1.200	1.220	1.128	1.200	1.260	0.39	0.52
RP154x023x	2.475	2.500	2.525	2.410	2.500	2.575	0.25	0.32	2.475	2.500	2.525	2.410	2.500	2.575	0.25	0.32
RP154x024x	3.267	3.300	3.333	3.182	3.300	3.399	0.22	0.31	2.970	3.000	3.030	2.892	3.000	3.090	0.22	0.31
RP154x025x	2.970	3.000	3.030	2.892	3.000	3.090	0.22	0.31	2.970	3.000	3.030	2.892	3.000	3.090	0.22	0.31

RP154N0xxx/RP154L0xxx Product-specific Electrical Characteristics

Product Name	VR1								VR2							
	V _{OUT} [V] (Ta = 25°C)			V _{OUT} [V] (-40°C ≤ Ta ≤ 105°C)			ΔV _{DIF} [V]		V _{OUT} [V] (Ta = 25°C)			V _{OUT} [V] (-40°C ≤ Ta ≤ 105°C)			ΔV _{DIF} [V]	
	Min.	Typ.	Max.	Min.	Typ.	Max.	Typ.	Max.	Min.	Typ.	Max.	Min.	Typ.	Max.	Typ.	Max.
RP154x026x	2.772	2.800	2.828	2.700	2.800	2.884	0.25	0.32	3.069	3.100	3.131	2.989	3.100	3.193	0.22	0.31
RP154x027x	2.277	2.300	2.323	2.218	2.300	2.369	0.26	0.36	2.772	2.800	2.828	2.700	2.800	2.884	0.25	0.32
RP154x028x	2.772	2.800	2.828	2.700	2.800	2.884	0.25	0.32	0.980	1.000	1.020	0.928	1.000	1.060	0.46	0.61
RP154x029x	1.480	1.500	1.520	1.428	1.500	1.560	0.35	0.46	1.480	1.500	1.520	1.428	1.500	1.560	0.35	0.46
RP154x030x	1.180	1.200	1.220	1.128	1.200	1.260	0.39	0.52	2.871	2.900	2.929	2.796	2.900	2.987	0.25	0.32
RP154x031x	2.624	2.650	2.676	2.555	2.650	2.729	0.25	0.32	2.822	2.850	2.878	2.748	2.850	2.935	0.25	0.32
RP154x032x	3.267	3.300	3.333	3.182	3.300	3.399	0.22	0.31	2.822	2.850	2.878	2.748	2.850	2.935	0.25	0.32
RP154x033x	1.780	1.800	1.820	1.728	1.800	1.860	0.30	0.41	2.871	2.900	2.929	2.796	2.900	2.987	0.25	0.32
RP154x034x	3.069	3.100	3.131	2.989	3.100	3.193	0.22	0.31	3.069	3.100	3.131	2.989	3.100	3.193	0.22	0.31
RP154x035x	2.772	2.800	2.828	2.700	2.800	2.884	0.25	0.32	2.673	2.700	2.727	2.603	2.700	2.781	0.25	0.32
RP154x036x	0.980	1.000	1.020	0.928	1.000	1.060	0.46	0.61	1.780	1.800	1.820	1.728	1.800	1.860	0.30	0.41
RP154x037x	1.180	1.200	1.220	1.128	1.200	1.260	0.39	0.52	2.475	2.500	2.525	2.410	2.500	2.575	0.25	0.32
RP154x038x	1.680	1.700	1.720	1.628	1.700	1.760	0.30	0.41	3.069	3.100	3.131	2.989	3.100	3.193	0.22	0.31
RP154x039x	1.780	1.800	1.820	1.728	1.800	1.860	0.30	0.41	2.475	2.500	2.525	2.410	2.500	2.575	0.25	0.32
RP154x040x	1.480	1.500	1.520	1.428	1.500	1.560	0.35	0.46	1.780	1.800	1.820	1.728	1.800	1.860	0.30	0.41
RP154x041x	1.780	1.800	1.820	1.728	1.800	1.860	0.30	0.41	2.673	2.700	2.727	2.603	2.700	2.781	0.25	0.32
RP154x042x	2.673	2.700	2.727	2.603	2.700	2.781	0.25	0.32	2.673	2.700	2.727	2.603	2.700	2.781	0.25	0.32
RP154x043x	2.871	2.900	2.929	2.796	2.900	2.987	0.25	0.32	2.871	2.900	2.929	2.796	2.900	2.987	0.25	0.32
RP154x044x	1.680	1.700	1.720	1.628	1.700	1.760	0.30	0.41	2.970	3.000	3.030	2.892	3.000	3.090	0.22	0.31
RP154x045x	1.730	1.750	1.770	1.678	1.750	1.810	0.30	0.41	2.970	3.000	3.030	2.892	3.000	3.090	0.22	0.31
RP154x046x	2.970	3.000	3.030	2.892	3.000	3.090	0.22	0.31	3.069	3.100	3.131	2.989	3.100	3.193	0.22	0.31
RP154x047x	1.730	1.750	1.770	1.678	1.750	1.810	0.30	0.41	3.069	3.100	3.131	2.989	3.100	3.193	0.22	0.31
RP154x048x	1.780	1.800	1.820	1.728	1.800	1.860	0.30	0.41	3.069	3.100	3.131	2.989	3.100	3.193	0.22	0.31
RP154x049x	2.475	2.500	2.525	2.410	2.500	2.575	0.25	0.32	3.069	3.100	3.131	2.989	3.100	3.193	0.22	0.31
RP154x050x	3.069	3.100	3.131	2.989	3.100	3.193	0.22	0.31	3.267	3.300	3.333	3.182	3.300	3.399	0.22	0.31

RP154N0xxx/RP154L0xxx Product-specific Electrical Characteristics

Product Name	VR1								VR2							
	V _{OUT} [V] (Ta = 25°C)			V _{OUT} [V] (-40°C ≤ Ta ≤ 105°C)			ΔV _{DIF} [V]		V _{OUT} [V] (Ta = 25°C)			V _{OUT} [V] (-40°C ≤ Ta ≤ 105°C)			ΔV _{DIF} [V]	
	Min.	Typ.	Max.	Min.	Typ.	Max.	Typ.	Max.	Min.	Typ.	Max.	Min.	Typ.	Max.	Typ.	Max.
RP154x051x	3.564	3.600	3.636	3.471	3.600	3.708	0.22	0.31	3.564	3.600	3.636	3.471	3.600	3.708	0.22	0.31
RP154N052x	1.780	1.800	1.820	1.728	1.800	1.860	0.30	0.41	2.970	3.000	3.030	2.892	3.000	3.090	0.22	0.31
RP154x053x	2.822	2.850	2.878	2.748	2.850	2.935	0.25	0.32	3.069	3.100	3.131	2.989	3.100	3.193	0.22	0.31
RP154x054x	1.180	1.200	1.220	1.128	1.200	1.260	0.39	0.52	1.180	1.200	1.220	1.128	1.200	1.260	0.39	0.52
RP154x055x	3.663	3.700	3.737	3.567	3.700	3.811	0.22	0.31	3.663	3.700	3.737	3.567	3.700	3.811	0.22	0.31
RP154N056x	1.080	1.100	1.120	1.028	1.100	1.160	0.46	0.61	1.780	1.800	1.820	1.728	1.800	1.860	0.30	0.41
RP154N057x	1.080	1.100	1.120	1.028	1.100	1.160	0.46	0.61	1.180	1.200	1.220	1.128	1.200	1.260	0.39	0.52
RP154N058x	0.980	1.000	1.020	0.928	1.000	1.060	0.46	0.61	3.267	3.300	3.333	3.182	3.300	3.399	0.22	0.31
RP154N059x	0.880	0.900	0.920	0.828	0.900	0.960	0.51	0.67	1.780	1.800	1.820	1.728	1.800	1.860	0.30	0.41
RP154N060x	0.880	0.900	0.920	0.828	0.900	0.960	0.51	0.67	0.880	0.900	0.920	0.828	0.900	0.960	0.51	0.67
RP154N061x	1.180	1.200	1.220	1.128	1.200	1.260	0.39	0.52	2.970	3.000	3.030	2.892	3.000	3.090	0.22	0.31
RP154N062x	2.772	2.800	2.828	2.700	2.800	2.884	0.25	0.32	2.871	2.900	2.929	2.796	2.900	2.987	0.25	0.32
RP154N063x	3.267	3.300	3.333	3.182	3.300	3.399	0.22	0.31	1.480	1.500	1.520	1.428	1.500	1.560	0.35	0.46
RP154N064x	1.080	1.100	1.120	1.028	1.100	1.160	0.46	0.61	2.871	2.900	2.929	2.796	2.900	2.987	0.25	0.32
RP154x065x	2.772	2.800	2.828	2.700	2.800	2.884	0.25	0.32	2.475	2.500	2.525	2.410	2.500	2.575	0.25	0.32
RP154x066x	0.780	0.800	0.820	0.728	0.800	0.860	0.56	0.74	1.780	1.800	1.820	1.728	1.800	1.860	0.30	0.41
RP154x067x	3.267	3.300	3.333	3.182	3.300	3.399	0.22	0.31	2.475	2.500	2.525	2.410	2.500	2.575	0.25	0.32
RP154x068x	1.280	1.300	1.320	1.228	1.300	1.360	0.39	0.52	1.780	1.800	1.820	1.728	1.800	1.860	0.30	0.41
RP154x069x	1.680	1.700	1.720	1.628	1.700	1.760	0.30	0.41	1.480	1.500	1.520	1.428	1.500	1.560	0.35	0.46
RP154x070x	1.180	1.200	1.220	1.128	1.200	1.260	0.39	0.52	1.280	1.300	1.320	1.228	1.300	1.360	0.39	0.52
RP154x071x	1.080	1.100	1.120	1.028	1.100	1.160	0.46	0.61	3.267	3.300	3.333	3.182	3.300	3.399	0.22	0.31

APPLICATION INFORMATION

Typical Application Circuit

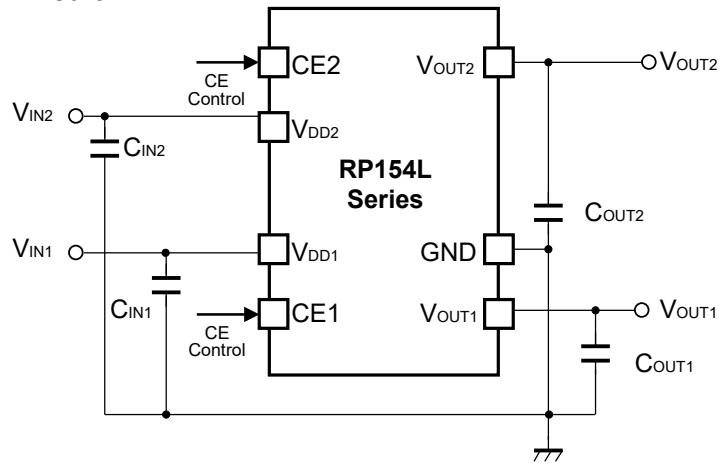

$C_{IN1} = C_{IN2} = C_{OUT1} = C_{OUT2} = \text{Ceramic } 1.0 \mu\text{F}$

RP154LxxxA/B Typical Application Circuit

External Components

Symbol	Description
C _{OUT1} , C _{OUT2}	Ceramic Capacitor, 1.0 μF , TDK: CGA3E1X7R1C105K080AC

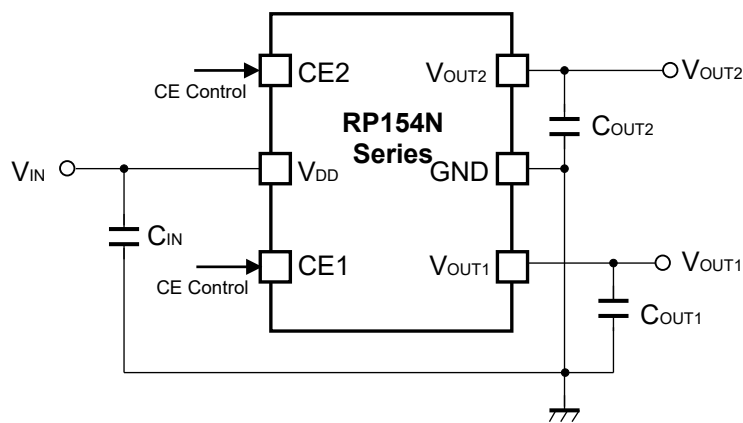

$C_{IN} = C_{OUT1} = C_{OUT2} = \text{Ceramic } 1.0 \mu\text{F}$

RP154NxxxA/B Typical Application Circuit

External Components

Symbol	Description
C _{OUT1} , C _{OUT2}	Ceramic Capacitor, 1.0 μF , TDK: CGA3E1X7R1C105K080AC

Typical Application Circuit for IC Chip Breakdown Prevention

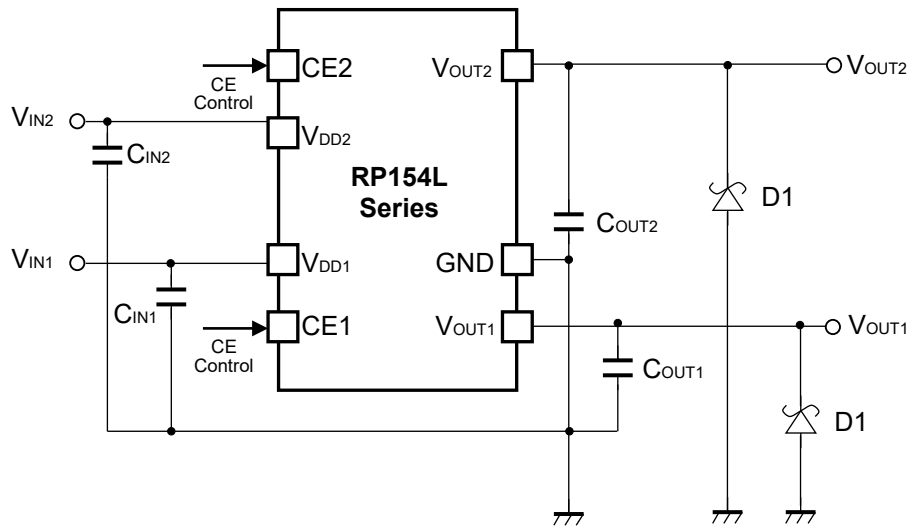

$C_{IN1} = C_{IN2} = C_{OUT1} = C_{OUT2} = \text{Ceramic } 1.0 \mu\text{F}$

RP154LxxxA/B Typical Application Circuit for IC Chip Breakdown Prevention

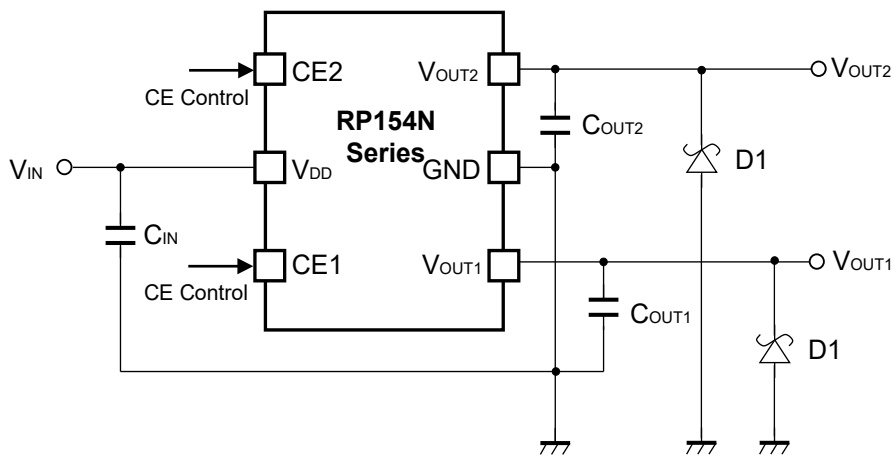

$C_{IN} = C_{OUT1} = C_{OUT2} = \text{Ceramic } 1.0 \mu\text{F}$

RP154NxxxA/B Typical Application Circuit for IC Chip Breakdown Prevention

When a sudden surge of electrical current travels along the VOUT pin and GND due to a short-circuit, electrical resonance of a circuit involving an output capacitor (C2) and a short circuit inductor generates a negative voltage and may damage the device or the load devices. Connecting a schottky diode (D1) between the VOUT pin and GND has the effect of preventing damage to them.

TECHNICAL NOTES

Phase Compensation

In these ICs, phase compensation is made for securing stable operation even if the load current is varied. For this purpose, use capacitors (1.0 μ F or more) for C_{OUT1} and C_{OUT2} with good frequency characteristics and ESR (Equivalent Series Resistance).

Note: If additional ceramic capacitors are connected with parallel to the output pin with an output capacitor for phase compensation, the operation might be unstable. Because of this, test these ICs with as same external components as ones to be used on the PCB. If the tantalum capacitor is used and its ESR (equivalent series resistance) is too large, the output may be unstable, therefore, fully evaluation is necessary.

PCB Layout

Make VDD and GND lines sufficient. If their impedance is high, noise pickup or unstable operation may result. Connect capacitors with a capacitance value as much as 1.0 μ F or more between VDD and GND pin, and as close as possible to the pins (C_{IN1}/C_{IN2}).

Set external components, especially the output capacitors, as close as possible to the ICs, and make wiring as short as possible (C_{OUT1}/C_{OUT2}).

TYPICAL CHARACTERISTICS

Note: Typical Characteristics are intended to be used as reference data; they are not guaranteed.

1) Output Voltage vs. Output Current ($C_{IN} = 1.0 \mu F$, $C_{OUT1} = C_{OUT2} = 1.0 \mu F$, $T_a = 25^\circ C$)

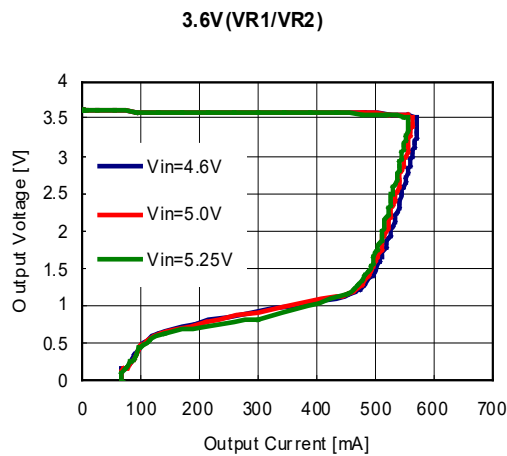
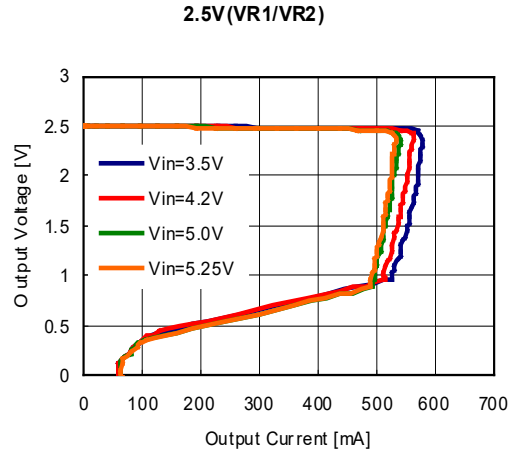
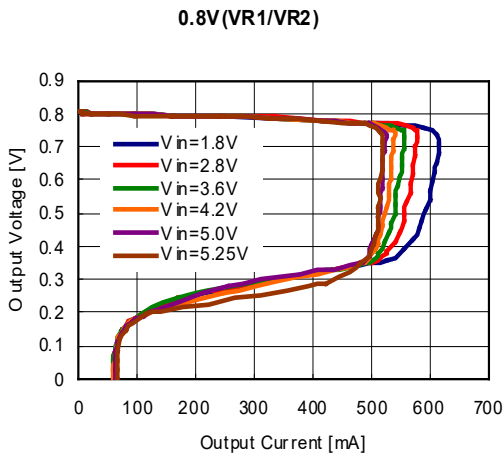

2) Output Voltage vs. Input Voltage ($C_{IN} = 1.0 \mu F$, $C_{OUT1} = C_{OUT2} = 1.0 \mu F$, $T_a = 25^\circ C$)

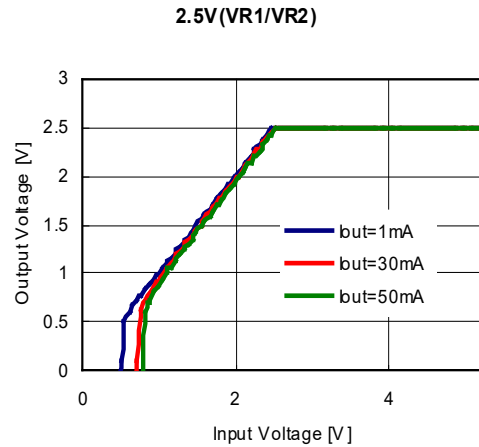
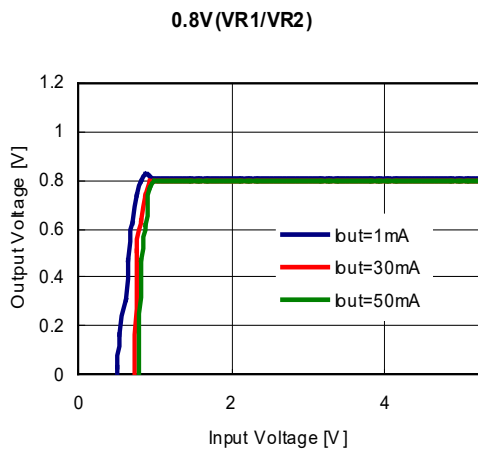

3.6V(VR1/VR2)

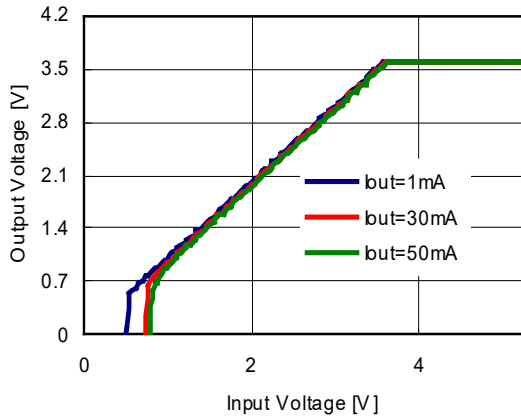

3) Supply Current vs. Input Voltage ($C_{IN} = 1.0 \mu F$, $C_{OUT1} = C_{OUT2} = 1.0 \mu F$, $T_a = 25^\circ C$)

0.8V(VR1/VR2)

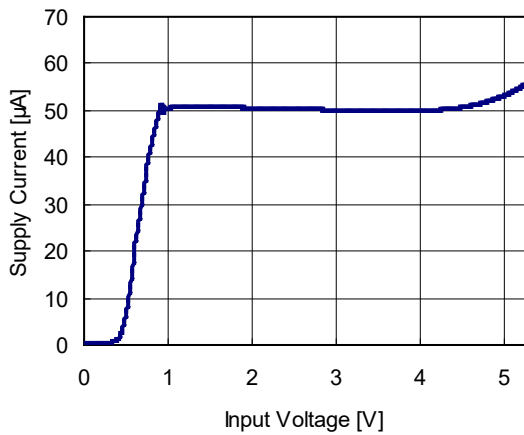

2.5V(VR1/VR2)

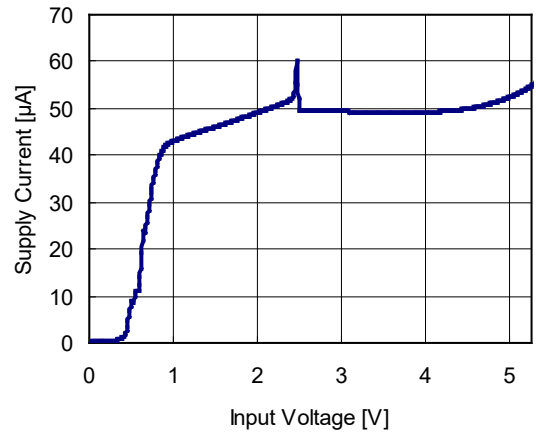

3.6V(VR1/VR2)

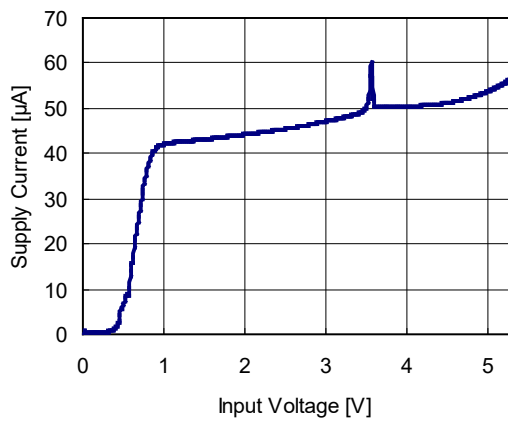

4) Output Voltage vs. Temperature ($C_{IN} = 1.0 \mu F$, $C_{OUT1} = C_{OUT2} = 1.0 \mu F$, $I_{OUT} = 5 \text{ mA}$)

0.8V (VR1/VR2)

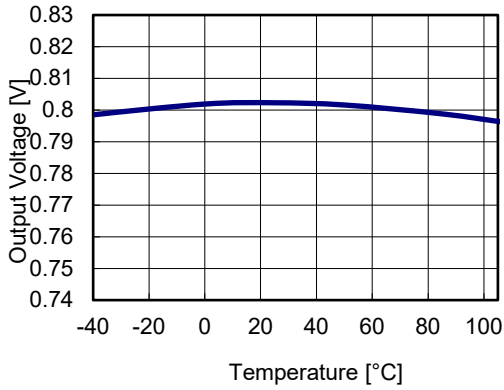

2.5V (VR1/VR2)

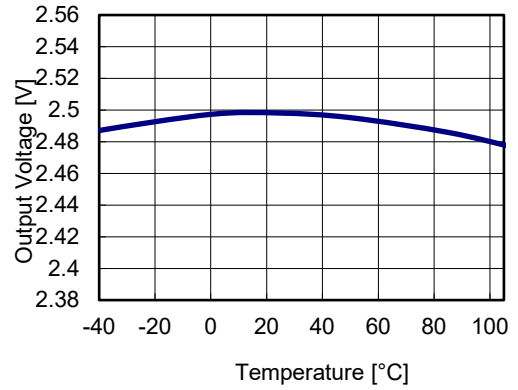

3.6V (VR1/VR2)

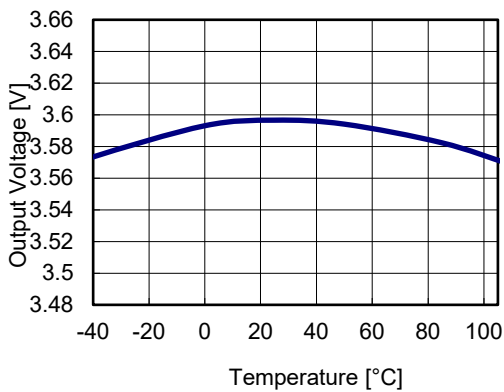

5) Supply Current vs. Temperature ($C_{IN} = 1.0 \mu F$, $C_{OUT1} = C_{OUT2} = 1.0 \mu F$)

0.8V (VR1/VR2)

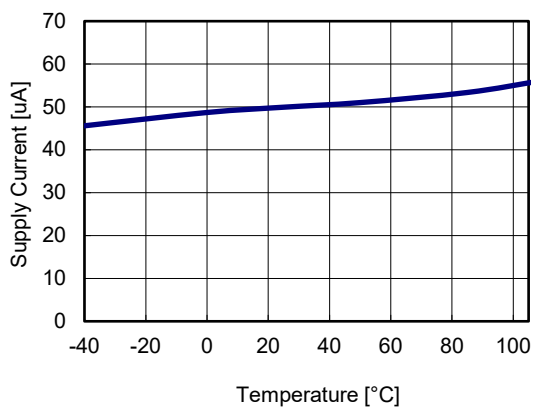

2.5V (VR1/VR2)

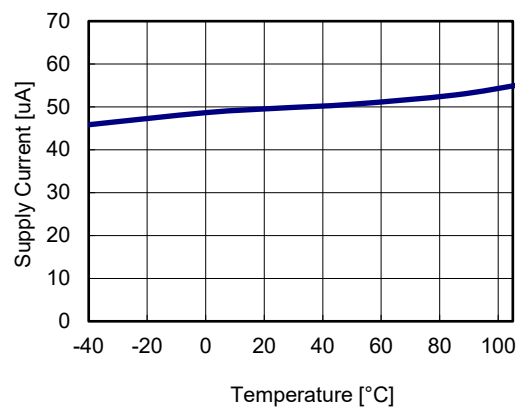

3.6V (VR1/VR2)

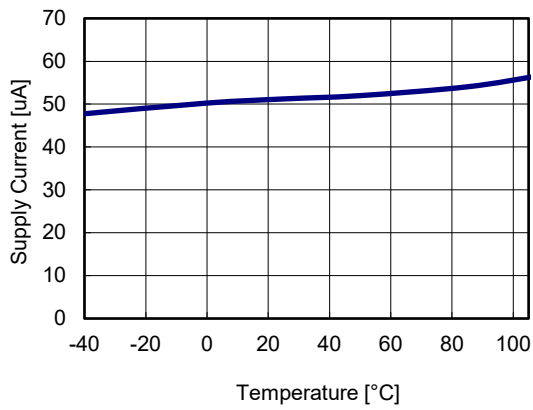

6) Dropout Voltage vs. Output Current ($C_{IN} = 1.0 \mu F$, $C_{OUT1} = C_{OUT2} = 1.0 \mu F$)

0.8V (VR1/VR2)

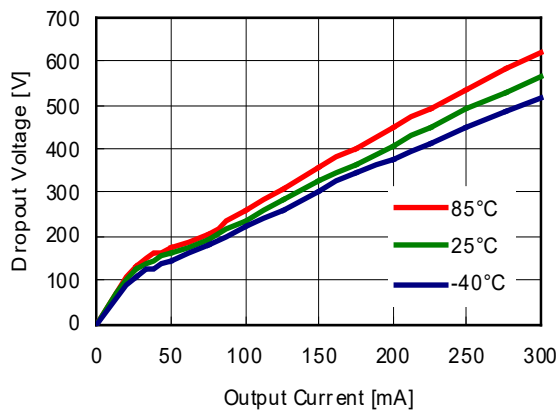

2.5V (VR1/VR2)

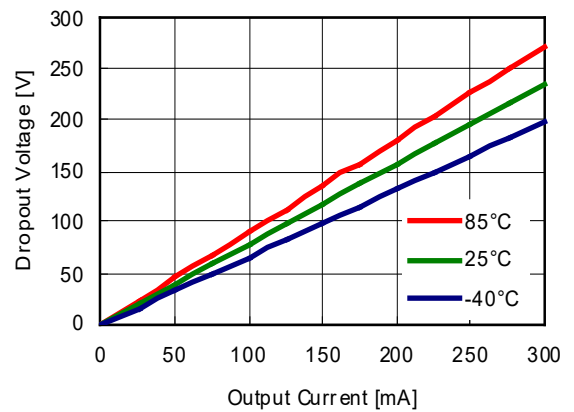

3.6V (VR1/VR2)

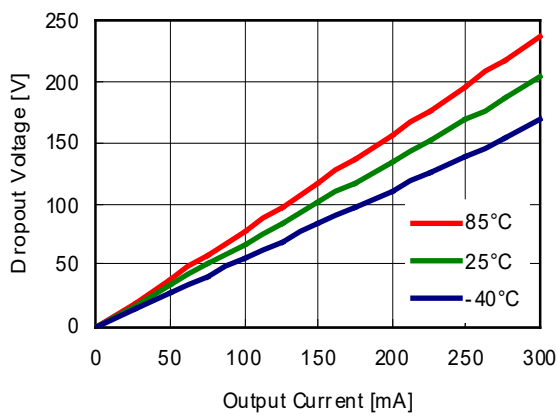

7) Dropout Voltage vs. Set Output Voltage

(VR1/VR2)

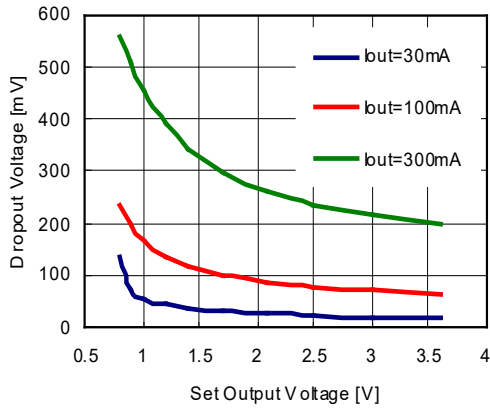

8) Ripple Rejection vs. Input Voltage (C_{IN} = none, C_{OUT1} = C_{OUT2} = 1.0 μF, Ripple = 0.2 Vp-p, Ta = 25°C)

2.5V(VR1/VR2)

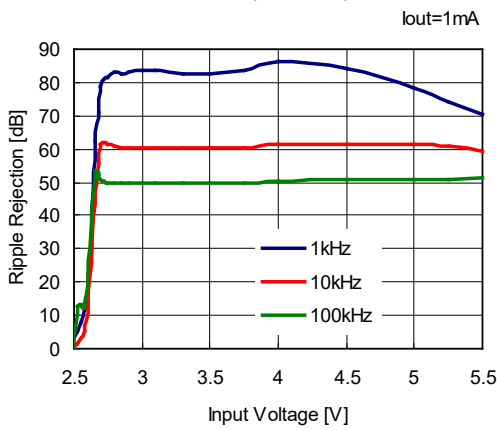

2.5V(VR1/VR2)

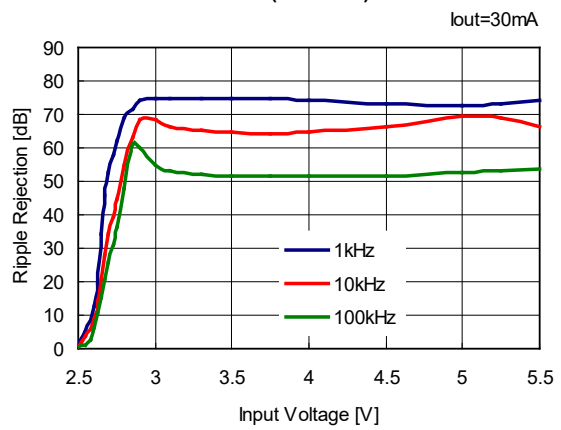

9) Ripple Rejection vs. Frequency (C_{IN} = none, C_{OUT1} = C_{OUT2} = 1.0 μF, Ta = 25°C)

0.8V(VR1/VR2)

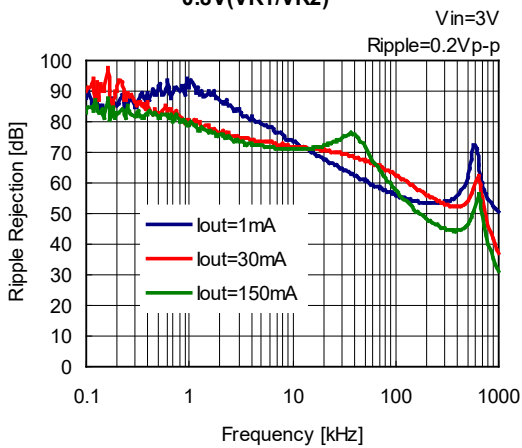

2.5V(VR1/VR2)

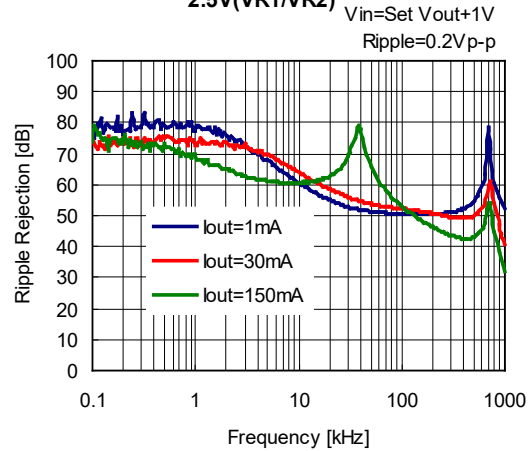

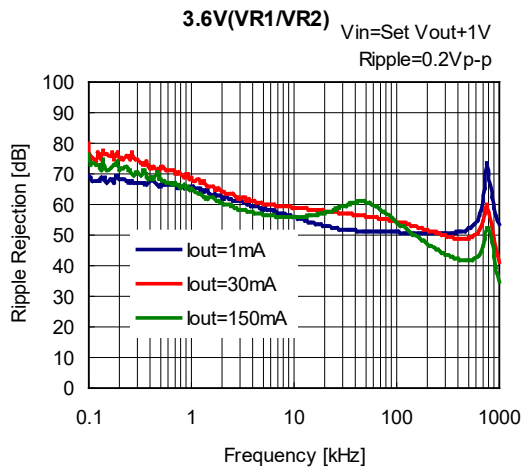

10) Input Transient Response ($C_{IN} = \text{none}$, $C_{OUT1} = C_{OUT2} = 1.0 \mu F$, $t_r = t_f = 5 \mu s$, $T_a = 25^\circ C$)

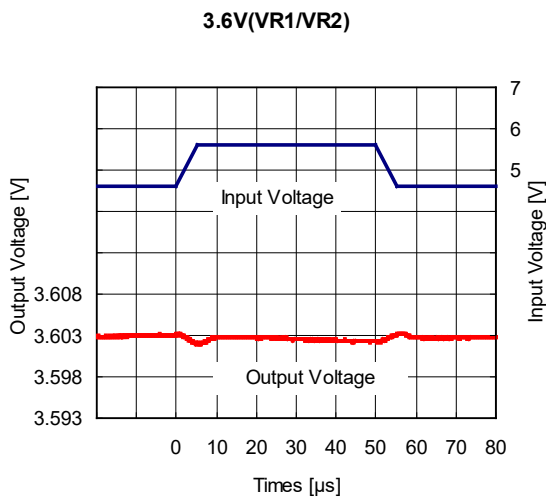
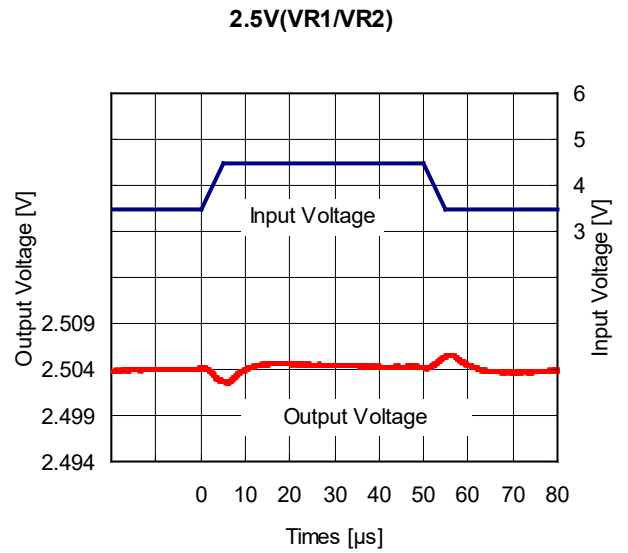
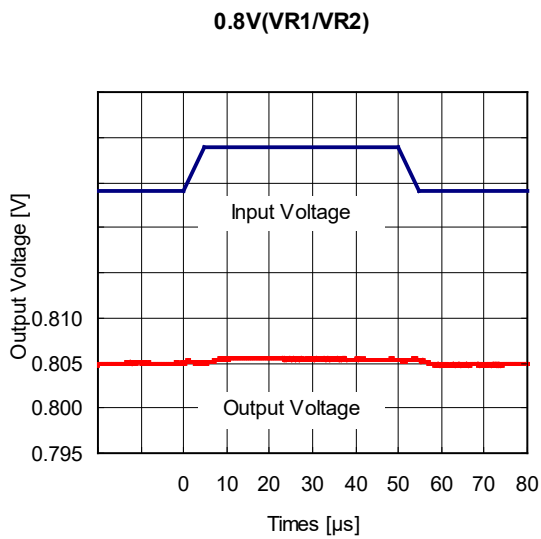

11) Load Transient Response ($C_{IN} = 1.0 \mu\text{F}$, $C_{OUT1} = C_{OUT2} = 1.0 \mu\text{F}$, $t_r = t_f = 0.5 \mu\text{s}$, $T_a = 25^\circ\text{C}$)

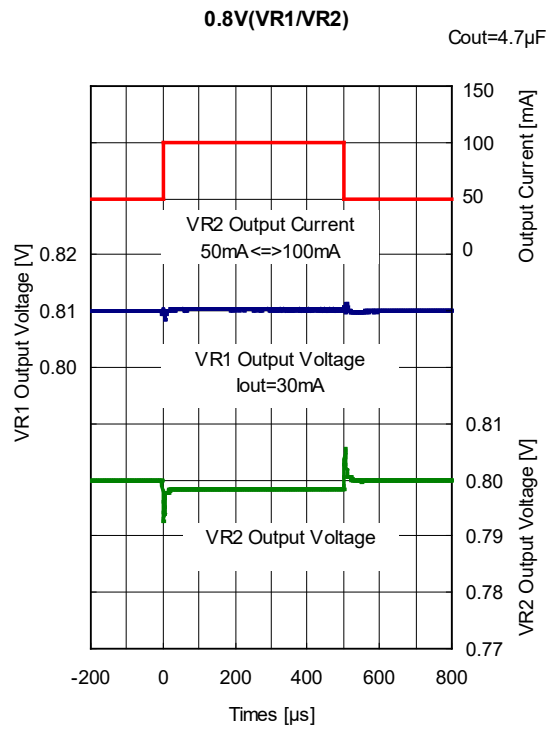
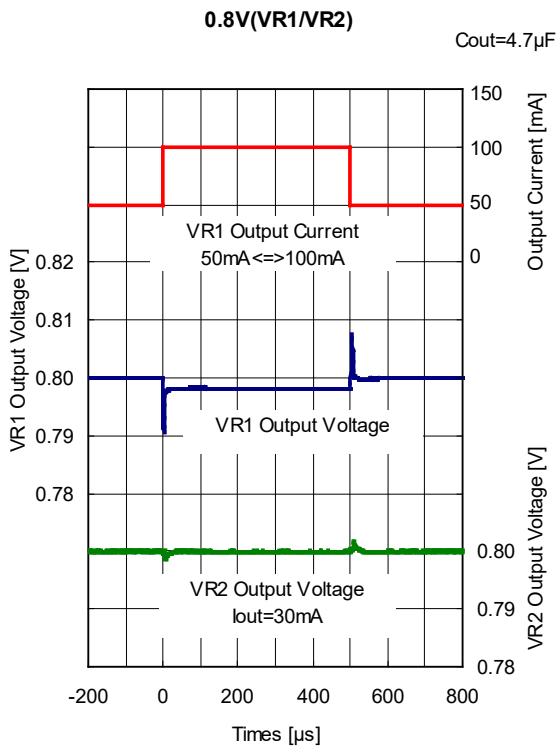
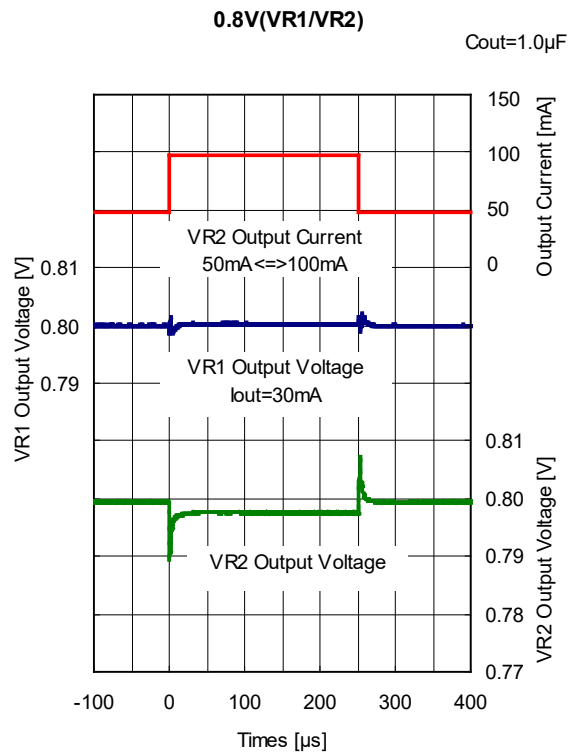
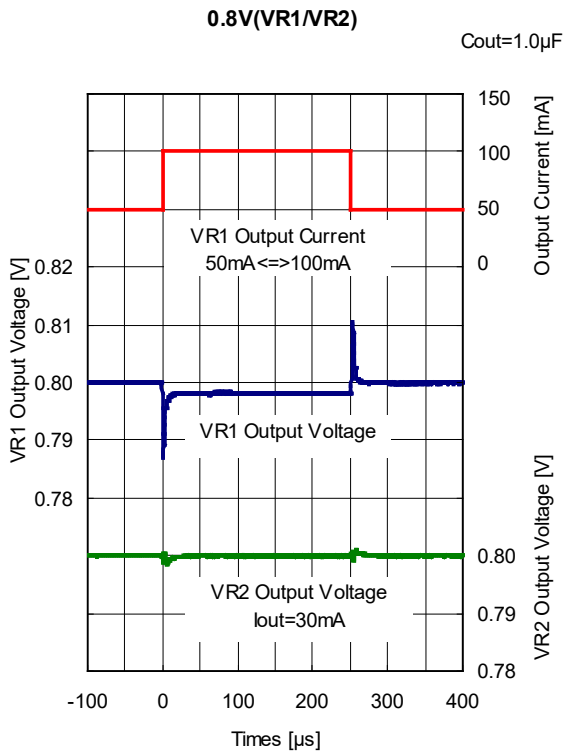

2.5V(VR1/VR2)

Cout=1.0μF

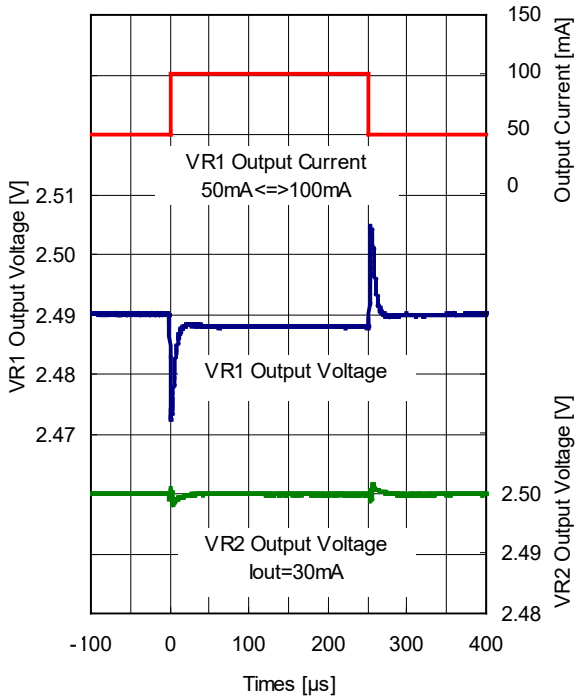

2.5V(VR1/VR2)

Cout=1.0μF

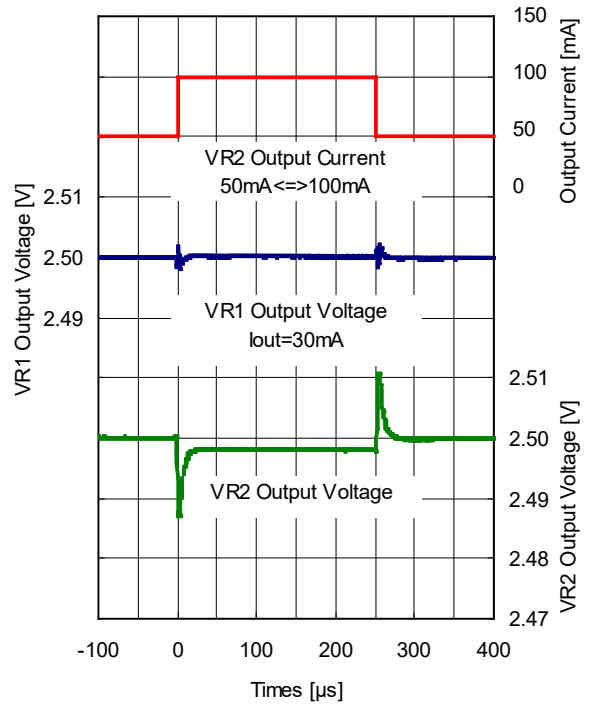

2.5V(VR1/VR2)

Cout=4.7μF

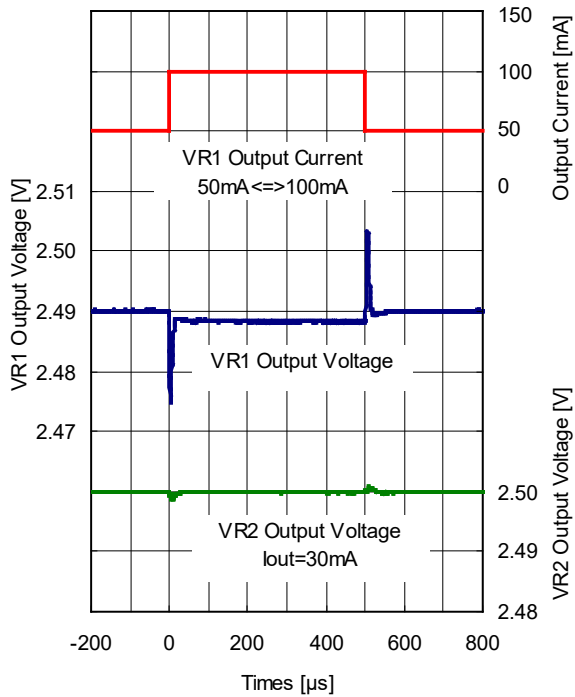

2.5V(VR1/VR2)

Cout=4.7μF

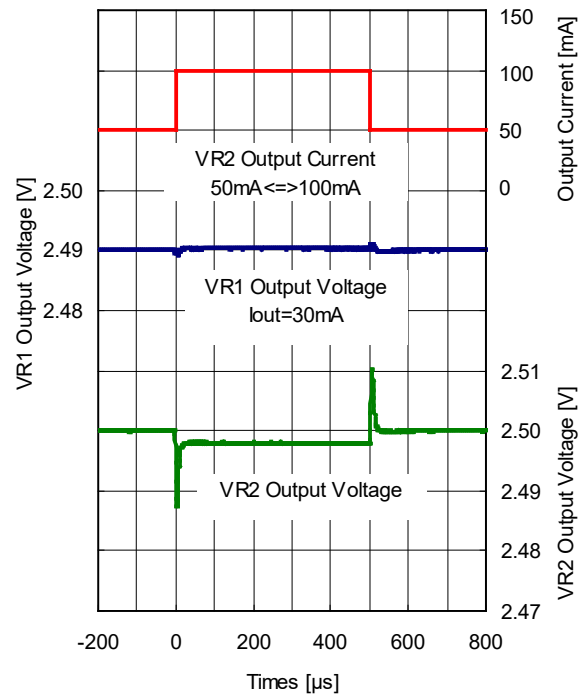

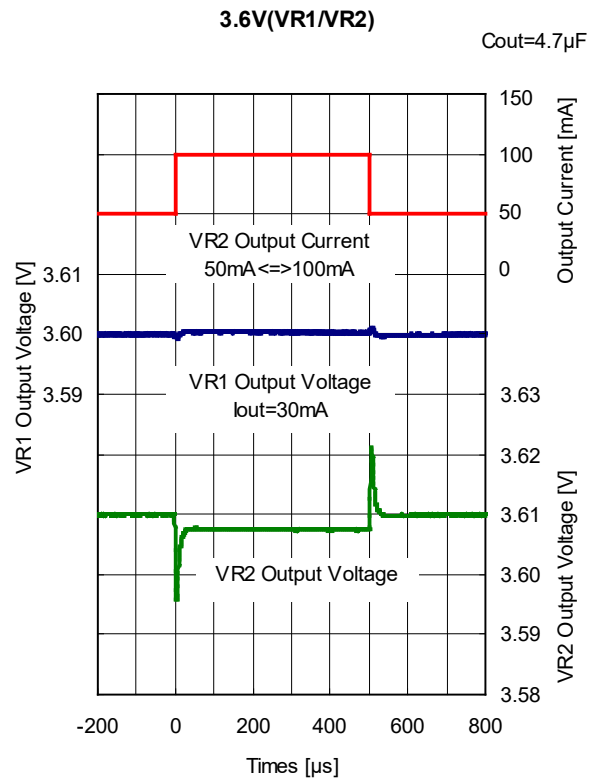
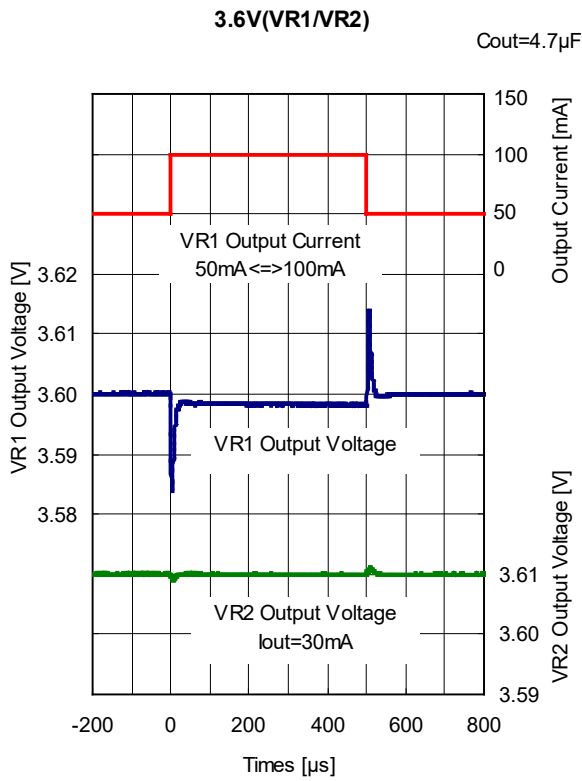
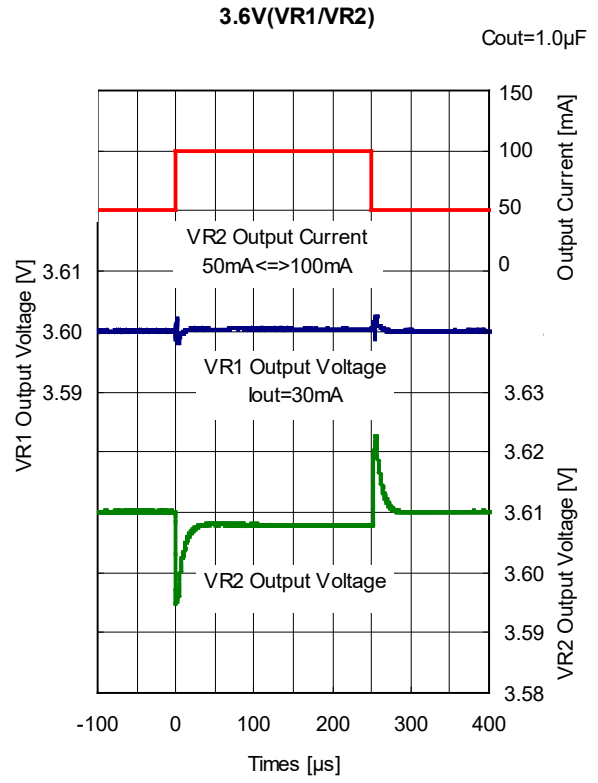
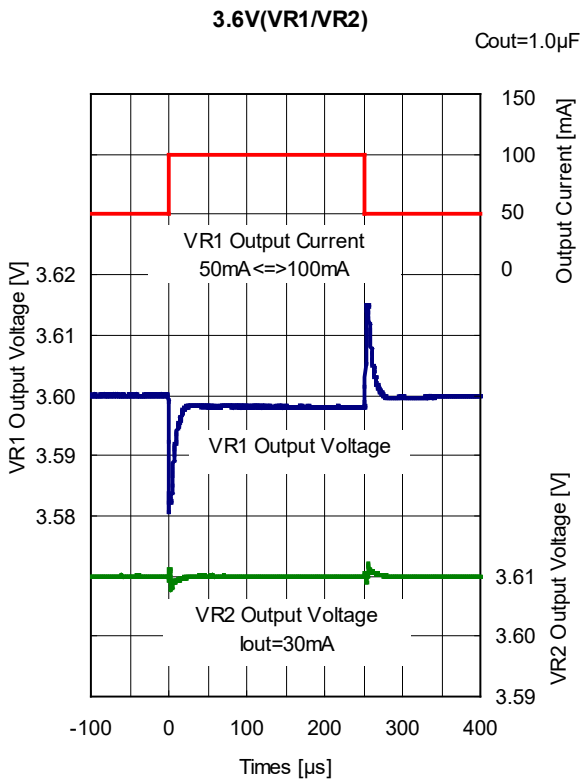

0.8V(VR1/VR2)

Cout=1.0μF

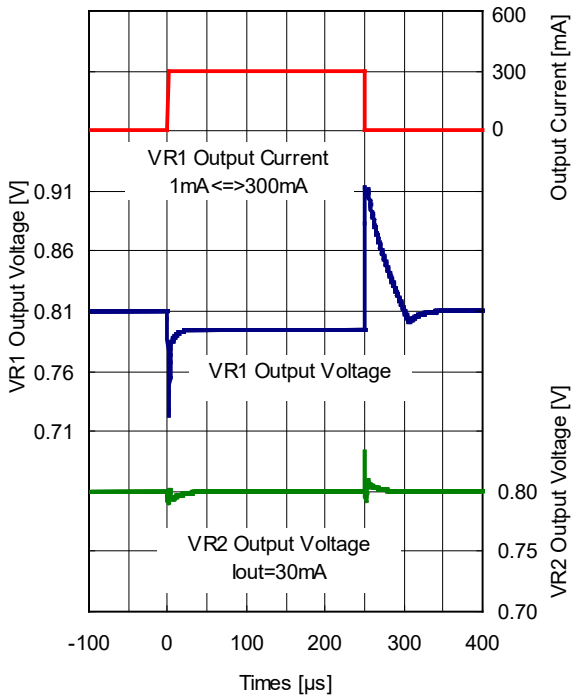

0.8V(VR1/VR2)

Cout=1.0μF

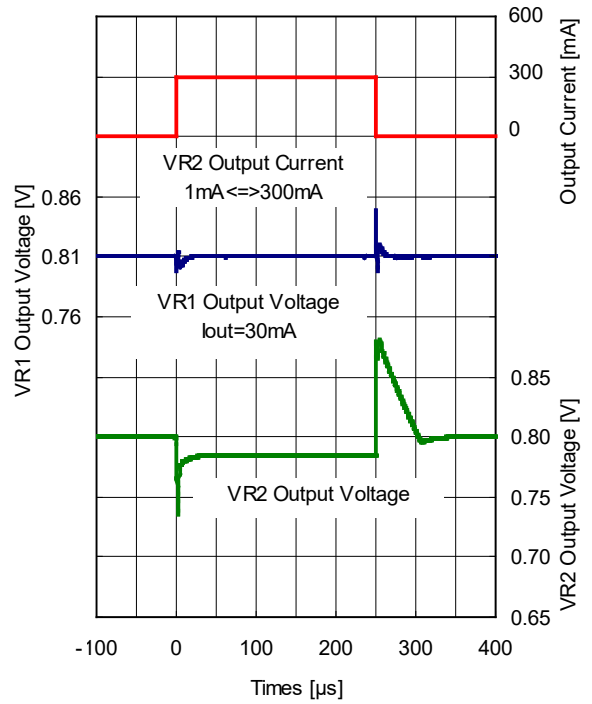

0.8V(VR1/VR2)

Cout=4.7μF

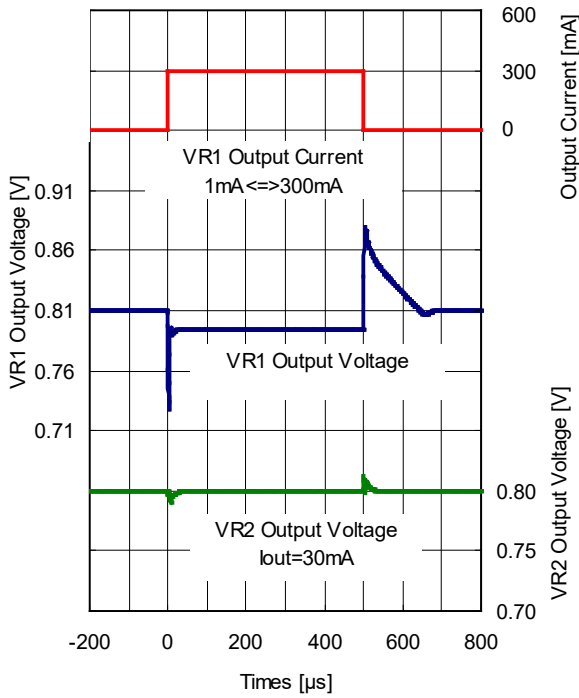

0.8V(VR1/VR2)

Cout=4.7μF

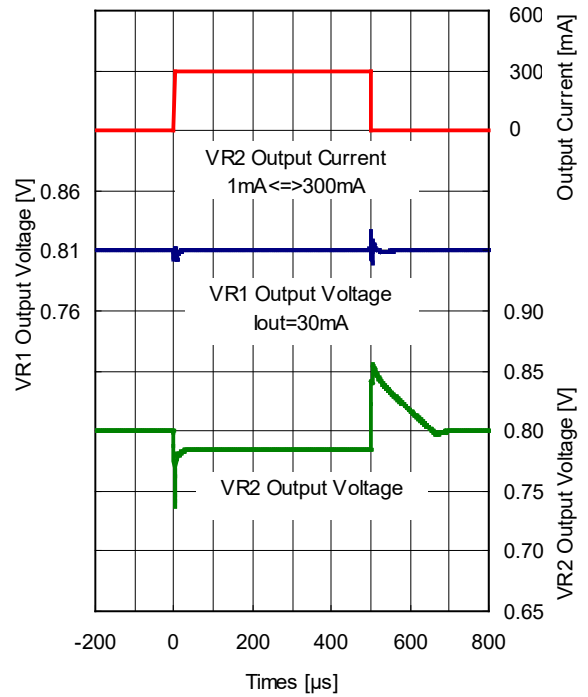

2.5V(VR1/VR2)

Cout=1.0μF

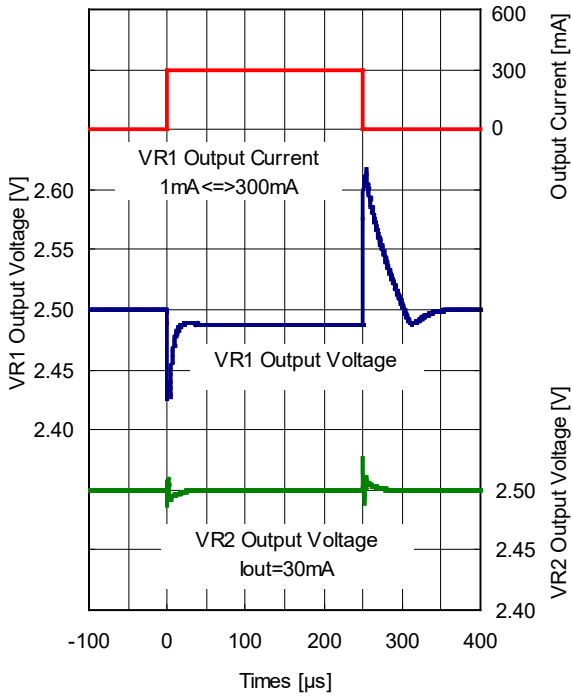

2.5V(VR1/VR2)

Cout=1.0μF

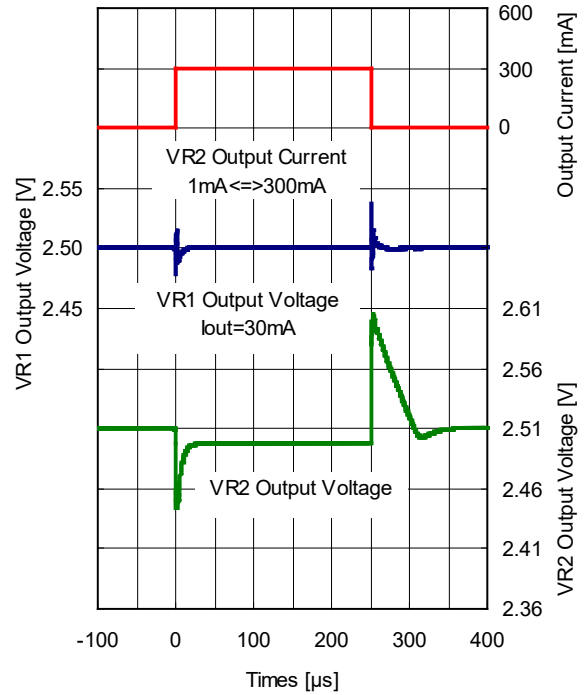

2.5V(VR1/VR2)

Cout=4.7μF

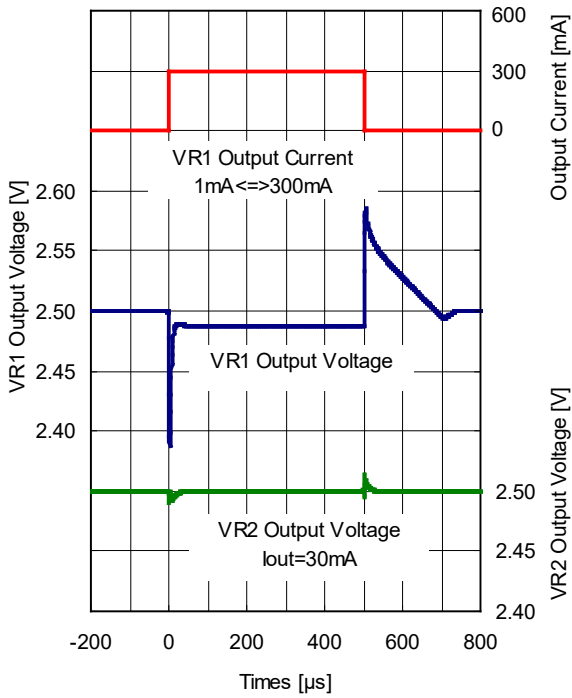

2.5V(VR1/VR2)

Cout=4.7μF

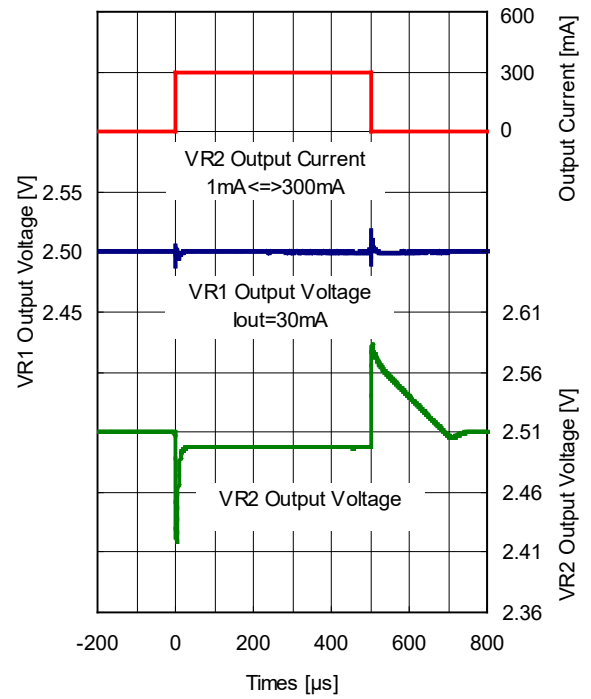

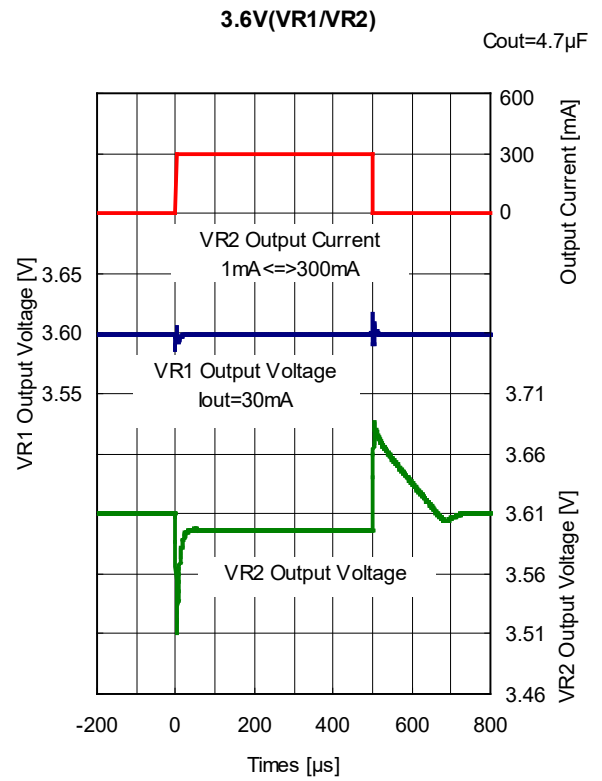
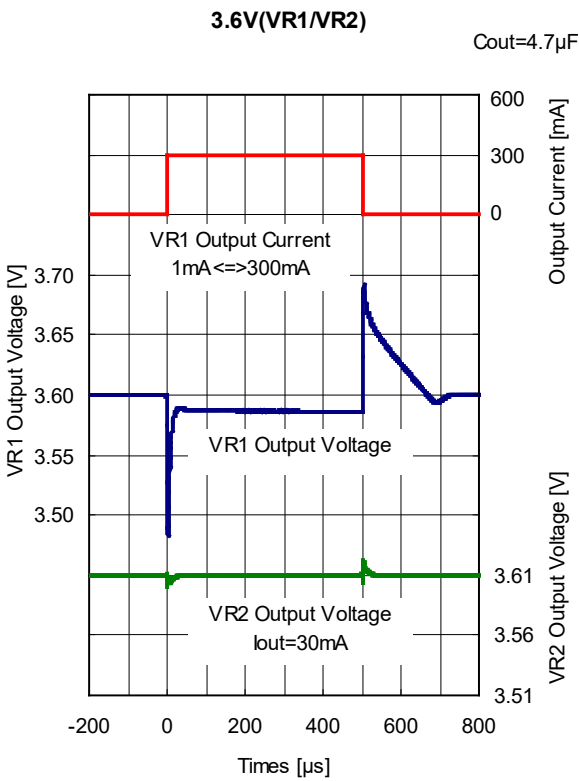
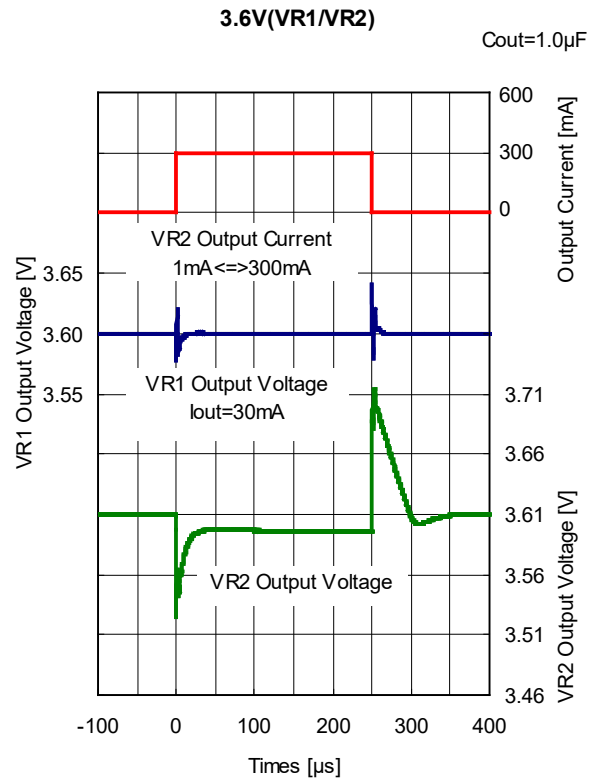
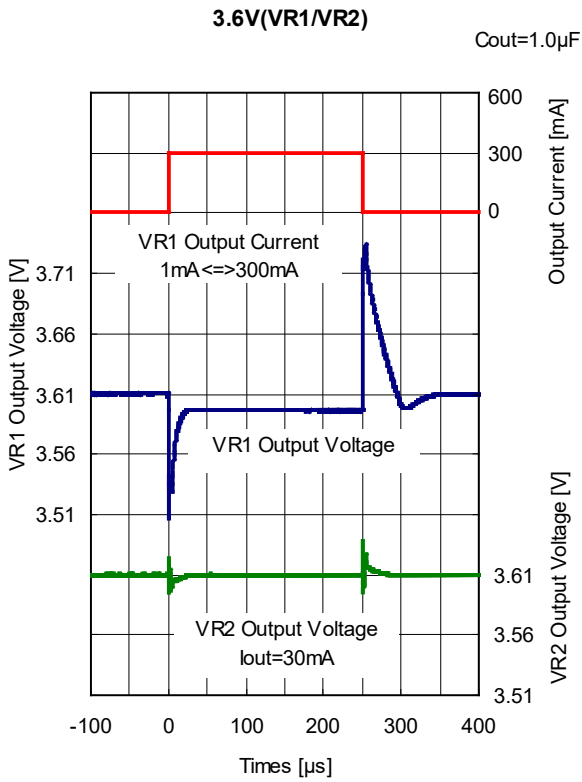

12) Turn On Speed with CE pin ($C_{IN} = 1.0 \mu F$, $C_{OUT1} = C_{OUT2} = 1.0 \mu F$, $T_a = 25^\circ C$)

0.8V(VR1/VR2)

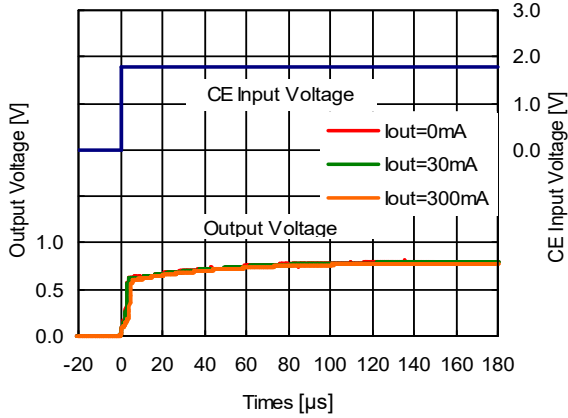

2.5V(VR1/VR2)

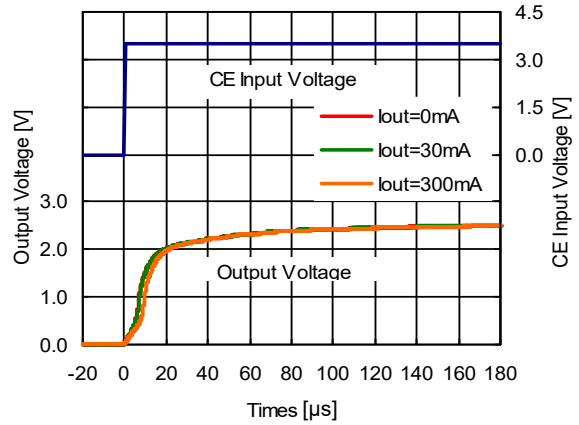

3.6V(VR1/VR2)

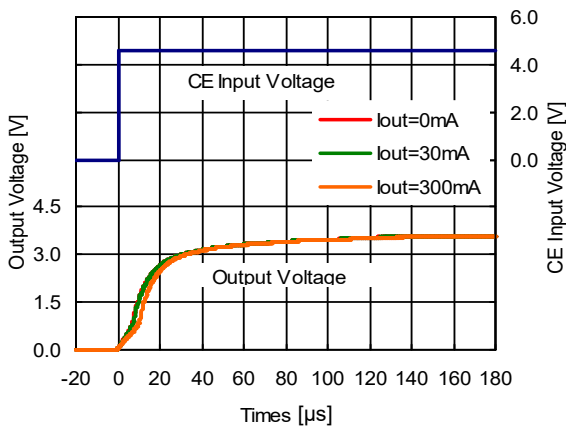

13) Turn Off Speed with CE pin (RP154xxxxB) ($C_{IN} = 1.0 \mu F$, $C_{OUT1} = C_{OUT2} = 1.0 \mu F$, $T_a = 25^\circ C$)

0.8V(VR1/VR2)

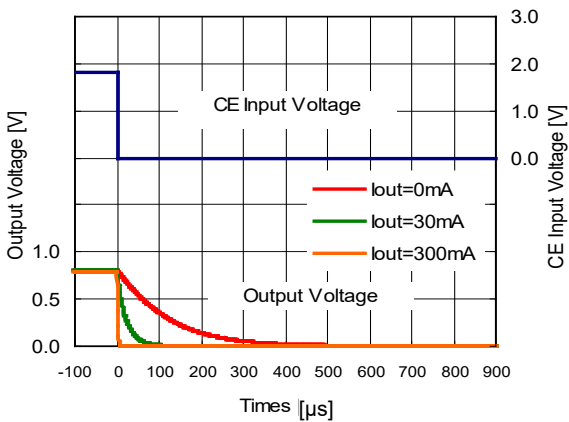

2.5V(VR1/VR2)

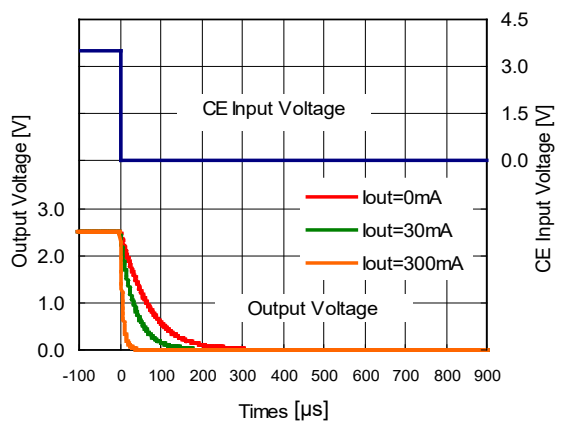

3.6V(VR1/VR2)

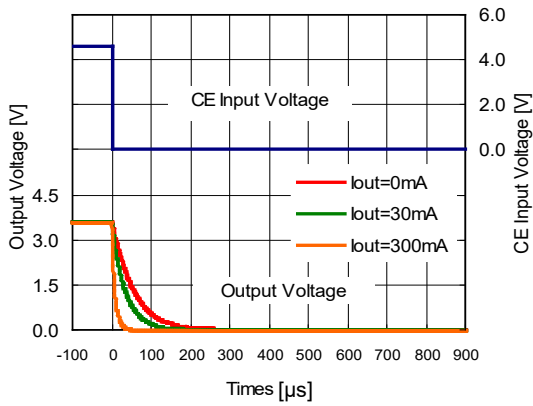

14) Turn Off Speed with CE pin (RP154xxxxA) ($C_{IN} = 1.0 \mu\text{F}$, $C_{OUT1} = C_{OUT2} = 1.0 \mu\text{F}$, $I_{OUT} = 0 \text{ mA}$, $T_a = 25^\circ\text{C}$)

0.8V(VR1/VR2)

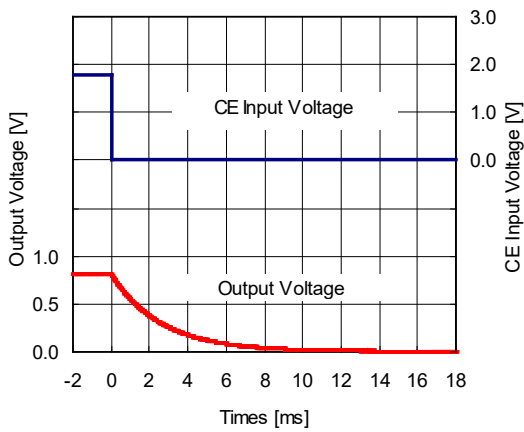

2.5V(VR1/VR2)

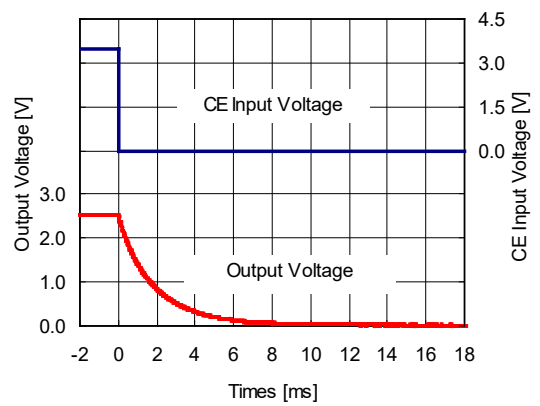

3.6V(VR1/VR2)

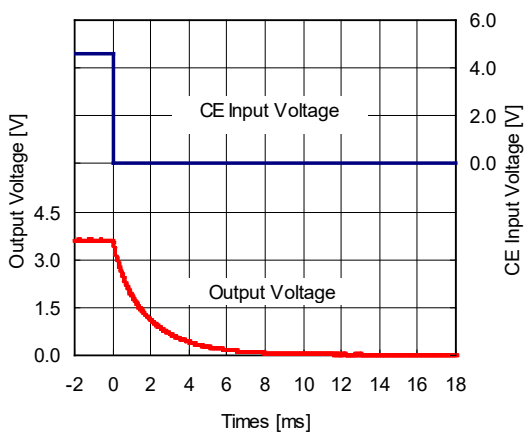

ESR vs. Output Current

When using these ICs, consider the following points:

The relations between I_{OUT} (Output Current) and ESR of an output capacitor are shown below.

The conditions when the white noise level is under 40 μ V (Avg.) are marked as the hatched area in the graph.

Measurement conditions

Frequency Band: 10 Hz to 2 MHz

Temperature: -40°C to 85°C

C_{IN} , C_{OUT1} , C_{OUT2} : 1.0 μ F

0.8V(VR1/VR2)

$V_{in}=0.8\text{V to }5.25\text{V}$

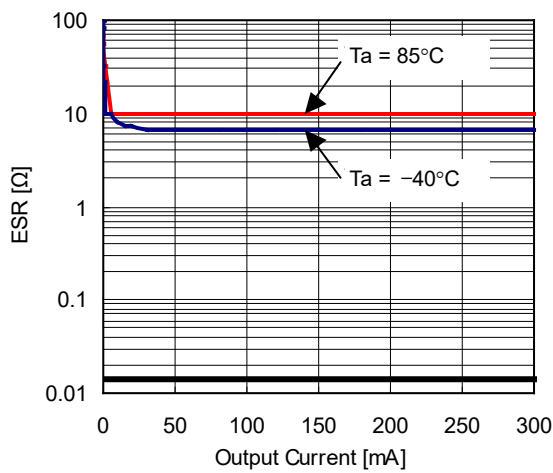

2.5V(VR1/VR2)

$V_{in}=2.5\text{V to }5.25\text{V}$

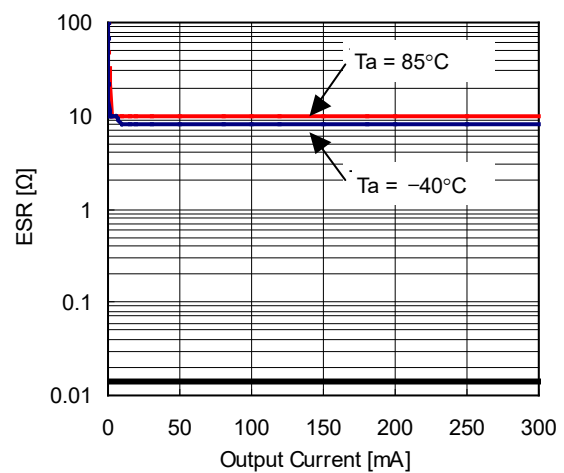

3.6V(VR1/VR2)

$V_{in}=3.6\text{V to }5.25\text{V}$

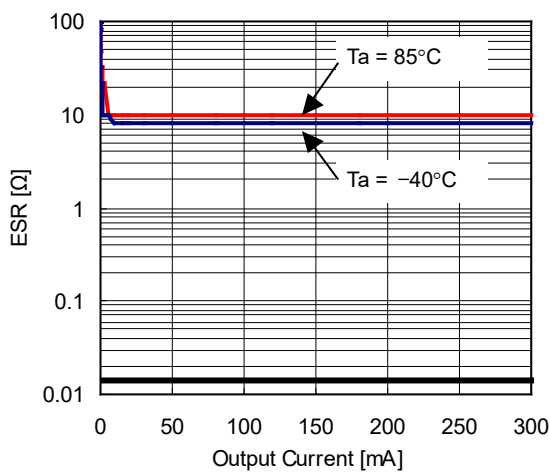

The power dissipation of the package is dependent on PCB material, layout, and environmental conditions. The following measurement conditions are based on JEDEC STD. 51-7.

Measurement Conditions

Item	Measurement Conditions
Environment	Mounting on Board (Wind Velocity = 0 m/s)
Board Material	Glass Cloth Epoxy Plastic (Four-Layer Board)
Board Dimensions	76.2 mm × 114.3 mm × 0.8 mm
Copper Ratio	Outer Layer (First Layer): Less than 95% of 50 mm Square Inner Layers (Second and Third Layers): Approx. 100% of 50 mm Square Outer Layer (Fourth Layer): Approx. 100% of 50 mm Square
Through-holes	φ 0.3 mm × 23 pcs

Measurement Result

(Ta = 25°C, Tjmax = 150°C)

Item	Measurement Result
Power Dissipation	3100 mW
Thermal Resistance (θ_{ja})	$\theta_{ja} = 40^\circ\text{C/W}$
Thermal Characterization Parameter (ψ_{jt})	$\psi_{jt} = 12^\circ\text{C/W}$

θ_{ja} : Junction-to-Ambient Thermal Resistance

ψ_{jt} : Junction-to-Top Thermal Characterization Parameter

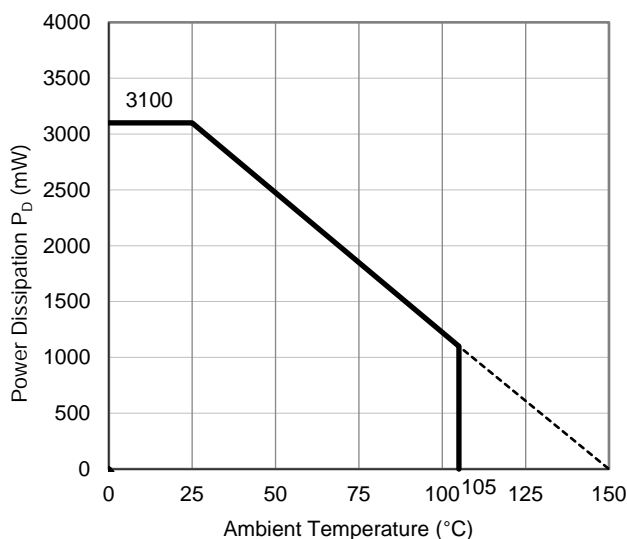

Power Dissipation vs. Ambient Temperature

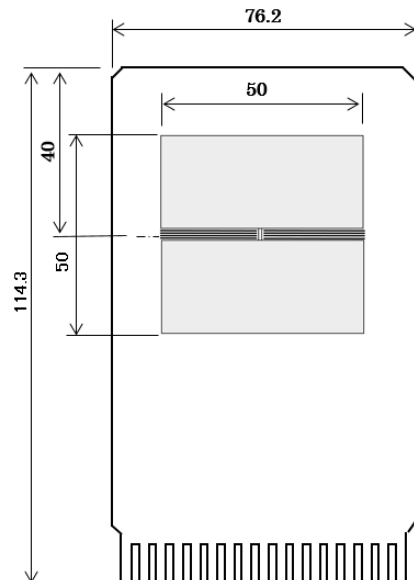

Measurement Board Pattern

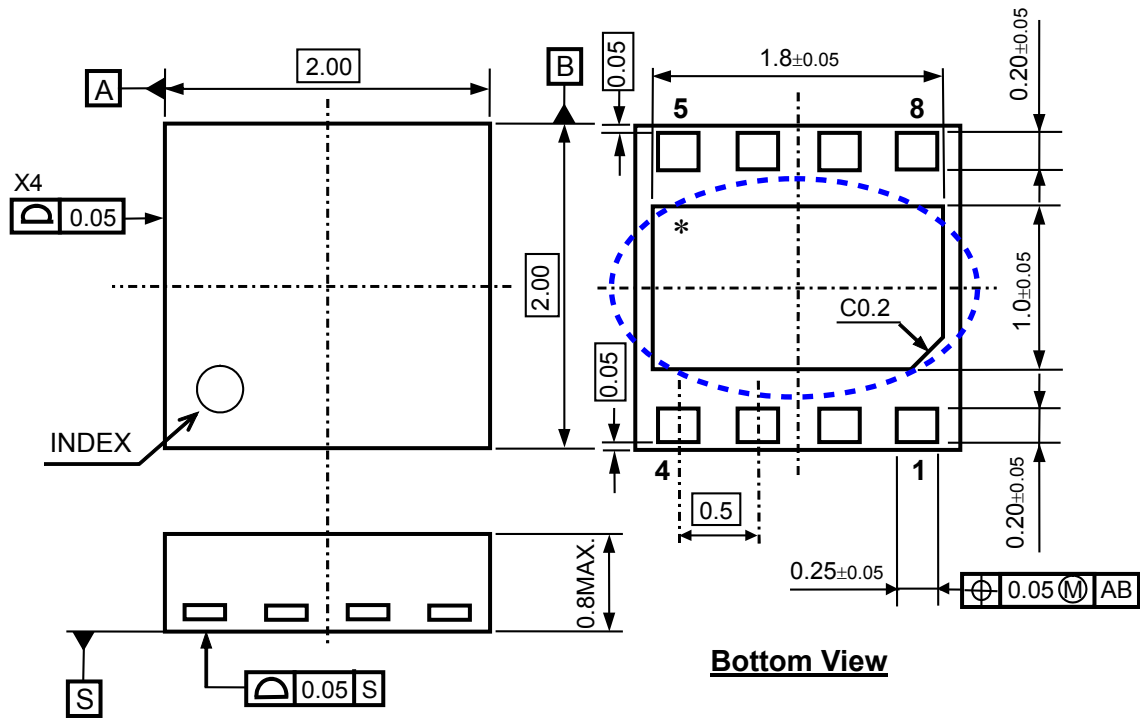

DFN2020-8 Package Dimensions (Unit: mm)

* The tab on the bottom of the package is substrate level (GND). It is recommended that the tab be connected to the ground plane on the board, or otherwise be left floating.

The power dissipation of the package is dependent on PCB material, layout, and environmental conditions. The following measurement conditions are based on JEDEC STD. 51-7.

Measurement Conditions

Item	Measurement Conditions
Environment	Mounting on Board (Wind Velocity = 0 m/s)
Board Material	Glass Cloth Epoxy Plastic (Four-Layer Board)
Board Dimensions	76.2 mm × 114.3 mm × 0.8 mm
Copper Ratio	Outer Layer (First Layer): Less than 95% of 50 mm Square Inner Layers (Second and Third Layers): Approx. 100% of 50 mm Square Outer Layer (Fourth Layer): Approx. 100% of 50 mm Square
Through-holes	φ 0.3 mm × 7 pcs

Measurement Result

(Ta = 25°C, Tjmax = 150°C)

Item	Measurement Result
Power Dissipation	830 mW
Thermal Resistance (θja)	θja = 150°C/W
Thermal Characterization Parameter (ψjt)	ψjt = 51°C/W

θja: Junction-to-Ambient Thermal Resistance

ψjt: Junction-to-Top Thermal Characterization Parameter

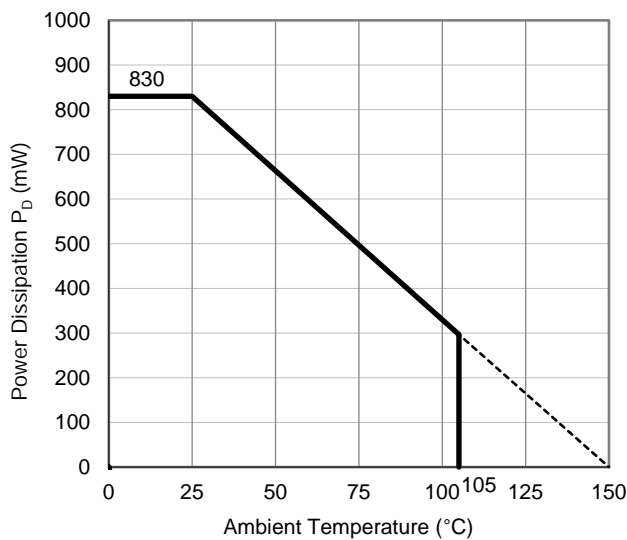

Power Dissipation vs. Ambient Temperature

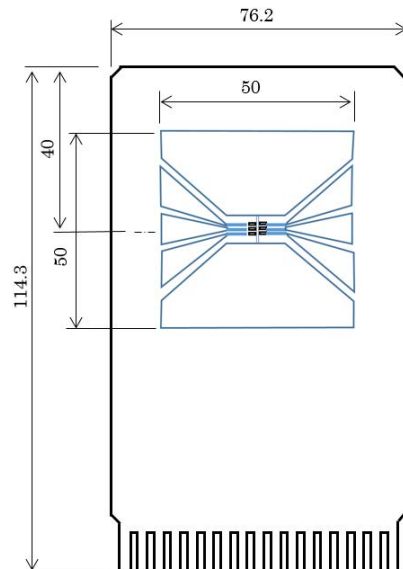

Measurement Board Pattern

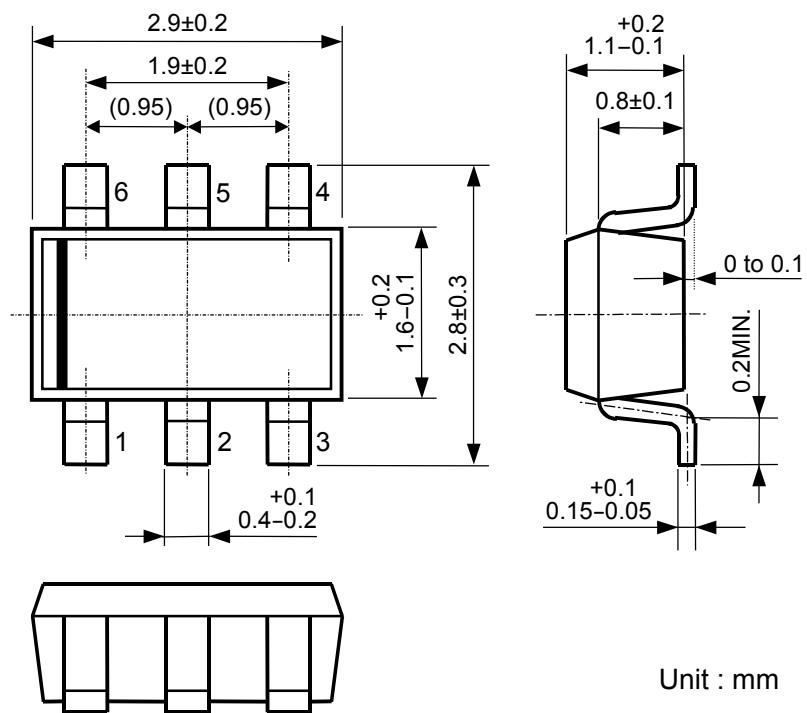

Unit : mm

SOT-23-6 Package Dimensions

The power dissipation of the package is dependent on PCB material, layout, and environmental conditions. The following measurement conditions are based on JEDEC STD. 51-7.

Measurement Conditions

Item	Measurement Conditions
Environment	Mounting on Board (Wind Velocity = 0 m/s)
Board Material	Glass Cloth Epoxy Plastic (Four-Layer Board)
Board Dimensions	76.2 mm × 114.3 mm × 0.8 mm
Copper Ratio	Outer Layer (First Layer): Less than 95% of 50 mm Square Inner Layers (Second and Third Layers): Approx. 100% of 50 mm Square Outer Layer (Fourth Layer): Approx. 100% of 50 mm Square
Through-holes	φ 0.2 mm × 25 pcs

Measurement Result

(Ta = 25°C, Tjmax = 150°C)

Item	Measurement Result
Power Dissipation	2200 mW
Thermal Resistance (θ_{ja})	$\theta_{ja} = 56^\circ\text{C/W}$
Thermal Characterization Parameter (ψ_{jt})	$\psi_{jt} = 18^\circ\text{C/W}$

θ_{ja} : Junction-to-Ambient Thermal Resistance

ψ_{jt} : Junction-to-Top Thermal Characterization Parameter

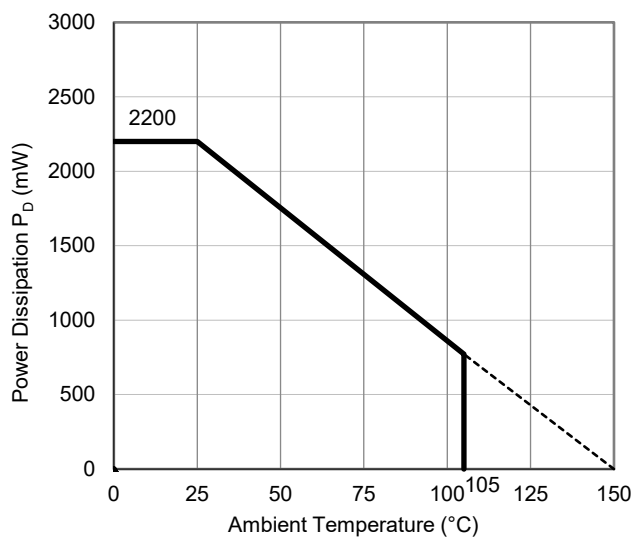

Power Dissipation vs. Ambient Temperature

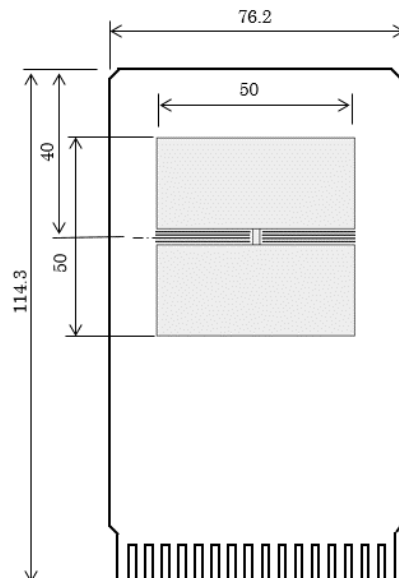

Measurement Board Pattern

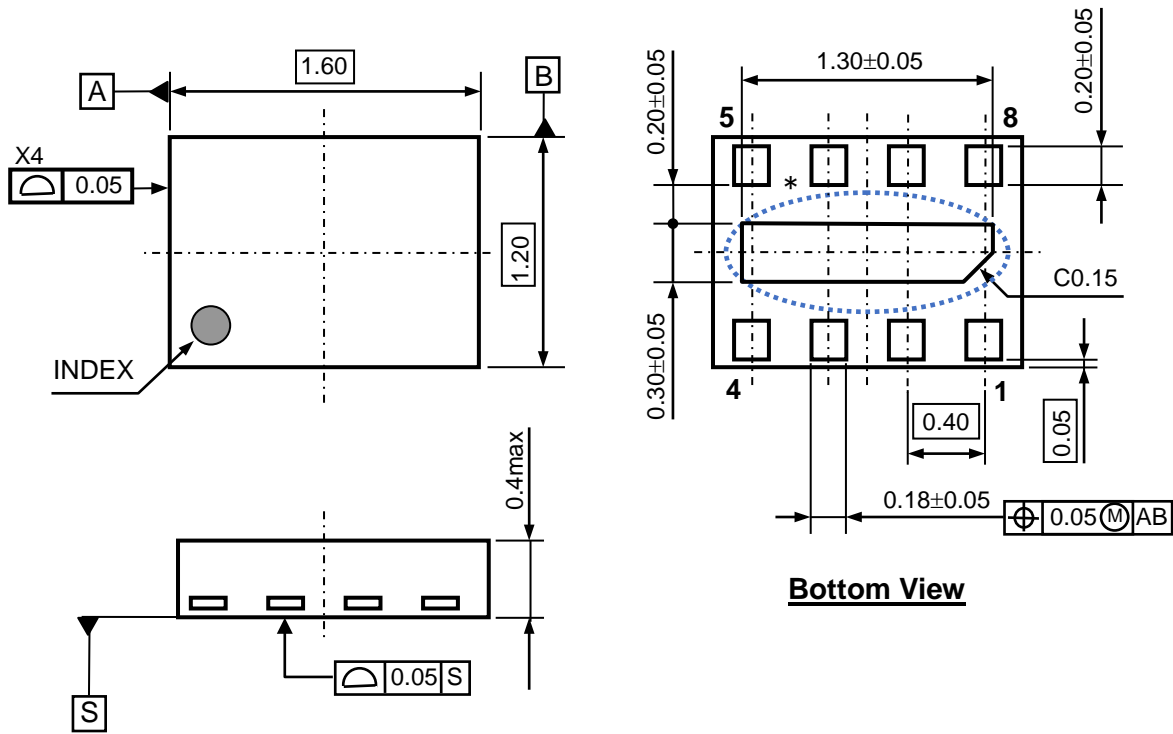

UNIT: mm

DFN1216-8 Package Dimensions

* The tab on the bottom of the package shown by blue circle is a substrate potential (GND). It is recommended that this tab be connected to the ground plane on the board but it is possible to leave the tab floating.

1. The products and the product specifications described in this document are subject to change or discontinuation of production without notice for reasons such as improvement. Therefore, before deciding to use the products, please refer to our sales representatives for the latest information thereon.
2. The materials in this document may not be copied or otherwise reproduced in whole or in part without the prior written consent of us.
3. This product and any technical information relating thereto are subject to complementary export controls (so-called KNOW controls) under the Foreign Exchange and Foreign Trade Law, and related politics ministerial ordinance of the law. (Note that the complementary export controls are inapplicable to any application-specific products, except rockets and pilotless aircraft, that are insusceptible to design or program changes.) Accordingly, when exporting or carrying abroad this product, follow the Foreign Exchange and Foreign Trade Control Law and its related regulations with respect to the complementary export controls.
4. The technical information described in this document shows typical characteristics and example application circuits for the products. The release of such information is not to be construed as a warranty of or a grant of license under our or any third party's intellectual property rights or any other rights.
5. The products listed in this document are intended and designed for use as general electronic components in standard applications (office equipment, telecommunication equipment, measuring instruments, consumer electronic products, amusement equipment etc.). Those customers intending to use a product in an application requiring extreme quality and reliability, for example, in a highly specific application where the failure or misoperation of the product could result in human injury or death should first contact us.
 - Aerospace Equipment
 - Equipment Used in the Deep Sea
 - Power Generator Control Equipment (nuclear, steam, hydraulic, etc.)
 - Life Maintenance Medical Equipment
 - Fire Alarms / Intruder Detectors
 - Vehicle Control Equipment (automotive, airplane, railroad, ship, etc.)
 - Various Safety Devices
 - Traffic control system
 - Combustion equipment

In case your company desires to use this product for any applications other than general electronic equipment mentioned above, make sure to contact our company in advance. Note that the important requirements mentioned in this section are not applicable to cases where operation requirements such as application conditions are confirmed by our company in writing after consultation with your company.

6. We are making our continuous effort to improve the quality and reliability of our products, but semiconductor products are likely to fail with certain probability. In order to prevent any injury to persons or damages to property resulting from such failure, customers should be careful enough to incorporate safety measures in their design, such as redundancy feature, fire containment feature and fail-safe feature. We do not assume any liability or responsibility for any loss or damage arising from misuse or inappropriate use of the products.
7. The products have been designed and tested to function within controlled environmental conditions. Do not use products under conditions that deviate from methods or applications specified in this datasheet. Failure to employ the products in the proper applications can lead to deterioration, destruction or failure of the products. We shall not be responsible for any bodily injury, fires or accident, property damage or any consequential damages resulting from misuse or misapplication of the products.
8. **Quality Warranty**
 - 8-1. **Quality Warranty Period**

In the case of a product purchased through an authorized distributor or directly from us, the warranty period for this product shall be one (1) year after delivery to your company. For defective products that occurred during this period, we will take the quality warranty measures described in section 8-2. However, if there is an agreement on the warranty period in the basic transaction agreement, quality assurance agreement, delivery specifications, etc., it shall be followed.
 - 8-2. **Quality Warranty Remedies**

When it has been proved defective due to manufacturing factors as a result of defect analysis by us, we will either deliver a substitute for the defective product or refund the purchase price of the defective product.
Note that such delivery or refund is sole and exclusive remedies to your company for the defective product.
 - 8-3. **Remedies after Quality Warranty Period**

With respect to any defect of this product found after the quality warranty period, the defect will be analyzed by us. On the basis of the defect analysis results, the scope and amounts of damage shall be determined by mutual agreement of both parties. Then we will deal with upper limit in Section 8-2. This provision is not intended to limit any legal rights of your company.
9. Anti-radiation design is not implemented in the products described in this document.
10. The X-ray exposure can influence functions and characteristics of the products. Confirm the product functions and characteristics in the evaluation stage.
11. WLCSP products should be used in light shielded environments. The light exposure can influence functions and characteristics of the products under operation or storage.
12. Warning for handling Gallium and Arsenic (GaAs) products (Applying to GaAs MMIC, Photo Reflector). These products use Gallium (Ga) and Arsenic (As) which are specified as poisonous chemicals by law. For the prevention of a hazard, do not burn, destroy, or process chemically to make them as gas or power. When the product is disposed of, please follow the related regulation and do not mix this with general industrial waste or household waste.
13. Please contact our sales representatives should you have any questions or comments concerning the products or the technical information.



Nisshinbo Micro Devices Inc.

Official website

<https://www.nisshinbo-microdevices.co.jp/en/>

Purchase information

<https://www.nisshinbo-microdevices.co.jp/en/buy/>