

### 200 mA 36 V Input Ultra Low Supply Current VR for Automotive Applications

NO.EC-348-160930

## OUTLINE

The R8160x is a CMOS-based ultra low supply current voltage regulator featuring 200 mA output current and 36 V input voltage. This device consists of an Output Short-circuit Protection Circuit, an Over-current Protection Circuit, and a Thermal Shutdown Circuit in addition to the basic regulator circuits. The operating temperature range is between  $-40^{\circ}\text{C}$  to  $125^{\circ}\text{C}$ , and the maximum input voltage is 36 V. All these features allow this device to become an ideal power source for ECUs.

The output voltages are internally fixed at either of the following: 3.3 V, 3.4 V, 5.0 V, 6.0 V, 8.0 V, 8.5 V and 9.0 V. The output voltage accuracy is  $\pm 1.6\%$ .

The packages for this device range from high-density mounting to ultra high wattage. The R8160x is offered in a 5-pin SOT-23-5, a 5-pin SOT-89-5, and a 6-pin HSOP-6J package.

## FEATURES

- Input Voltage Range (Maximum Rating) ..... 3.5 V to 36 V (50 V)
- Operating Temperature Range .....  $-40^{\circ}\text{C}$  to  $125^{\circ}\text{C}$
- Supply Current ..... Typ. 2.2  $\mu\text{A}$
- Standby Current ..... Typ. 0.1  $\mu\text{A}$
- Dropout Voltage ..... Typ. 0.6 V ( $I_{\text{OUT}} = 200 \text{ mA}$ ,  $V_{\text{OUT}} = 5.0 \text{ V}$ )
- Output Voltage Range ..... 3.3 V / 3.4 V / 5.0 V / 6.0 V / 8.0 V / 8.5 V / 9.0 V  
\*Contact our sales representatives for other voltages.
- Output Voltage Accuracy .....  $\pm 1.6\%$
- Line Regulation ..... Typ. 0.01%/V ( $V_{\text{SET}} + 1 \text{ V} \leq V_{\text{IN}} \leq 36 \text{ V}$ )
- Built-in Output Short-circuit Protection Circuit ..... Typ. 80 mA
- Built-in Over-current Protection Circuit ..... Typ. 350 mA
- Built-in Thermal Shutdown Circuit ..... Thermal Shutdown Temperature: Typ.  $160^{\circ}\text{C}$
- Ceramic capacitors are recommended  
to be used with this device .....  $C_{\text{OUT}} = 0.1 \mu\text{F}$  or more
- Packages ..... SOT-23-5, SOT-89-5, HSOP-6J

## APPLICATIONS

- Power source for ECUs such as EV inverter and battery charge control unit

# R8160x

NO.EC-348-160930

## BLOCK DIAGRAM

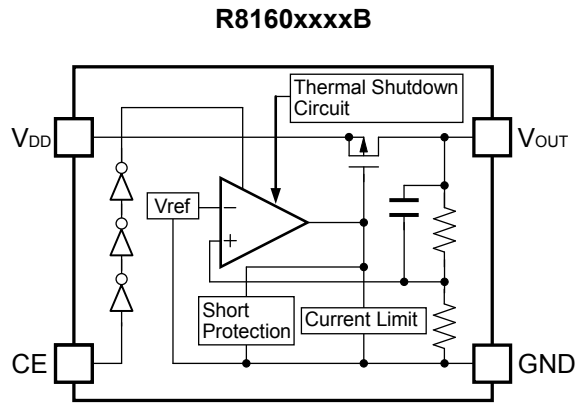

## SELECTION GUIDE

The set output voltage and the package type are user-selectable.

Product Name	Package	Quantity per Reel	Pb Free	Halogen Free
R8160NxxxB-TR-FE	SOT-23-5	3,000 pcs	Yes	Yes
R8160HxxxB-T1-FE	SOT-89-5	1,000 pcs	Yes	Yes
R8160SxxxB-E2-FE	HSOP-6J	1,000 pcs	Yes	Yes

xxx: Specify the set output voltage ( $V_{SET}$ )  
 3.3 V (033) / 3.4 V (034) / 5.0 V (050) / 6.0 V (060) / 8.0 V (080) / 8.5 V (085) / 9.0 V (090)  
 \*Contact our sales representatives for other voltages.

R8 Automotive Class Code

Operating Temperature Range	Guaranteed Specs Temperature Range	Screening
-40°C to 125°C	-40°C to 125°C	High and Low Temperature

## PIN DESCRIPTIONS

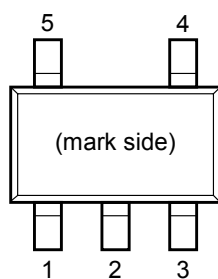

SOT-23-5

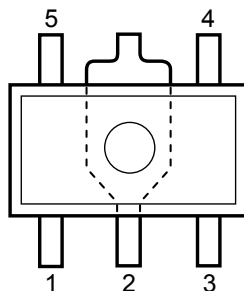

SOT-89-5

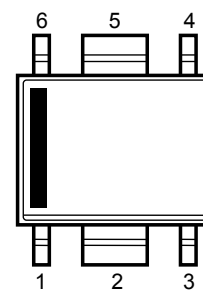

HSOP-6J

### SOT-23-5

Pin No.	Symbol	Description
1	GND <sup>*1</sup>	Ground Pin
2	GND <sup>*1</sup>	Ground Pin
3	CE	Chip Enable Pin (Active-high)
4	V <sub>OUT</sub>	Output Pin
5	V <sub>DD</sub>	Input Pin

<sup>\*1</sup> The GND pin must be wired together when it is mounted on board.

### SOT-89-5

Pin No.	Symbol	Description
1	V <sub>OUT</sub>	Output Pin
2	GND <sup>*2</sup>	Ground Pin
3	CE	Chip Enable Pin (Active-high)
4	GND <sup>*2</sup>	Ground Pin
5	V <sub>DD</sub>	Input Pin

<sup>\*2</sup> The GND pin must be wired together when it is mounted on board.

### HSOP-6J

Pin No.	Symbol	Description
1	V <sub>OUT</sub>	Output Pin
2	GND <sup>*3</sup>	Ground Pin
3	CE	Chip Enable Pin (Active-high)
4	GND <sup>*3</sup>	Ground Pin
5	GND <sup>*3</sup>	Ground Pin
6	V <sub>DD</sub>	Input Pin

<sup>\*3</sup> The GND pin must be wired together when it is mounted on board.

**PIN EQUIVALENT CIRCUIT DIAGRAMS**

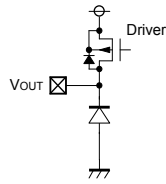

**V<sub>OUT</sub> Pin**

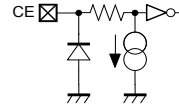

**CE Pin**

**ABSOLUTE MAXIMUM RATINGS**

Symbol	Item		Rating	Unit	
V <sub>IN</sub>	Input Voltage		-0.3 to 50	V	
V <sub>IN</sub>	Peak Input Voltage*1		60	V	
V <sub>CE</sub>	Input Voltage (CE Pin)		-0.3 to 50	V	
V <sub>OUT</sub>	Output Voltage		-0.3 to V <sub>IN</sub> + 0.3 ≤ 50	V	
I <sub>OUT</sub>	Output Current		300	mA	
P <sub>D</sub>	Power Dissipation*2	SOT-23-5	Standard Land Pattern	525	mW
		SOT-89-5	Standard Land Pattern	1120	
			High Wattage Land Pattern	1620	
		HSOP-6J	Standard Land Pattern	2100	
			Ultra High Wattage Land Pattern	3400	
T <sub>j</sub>	Junction Temperature		-40 to 150	°C	
T <sub>stg</sub>	Storage Temperature Range		-55 to 150	°C	

\*1 Duration time: 200 ms

\*2 Refer to *PACKAGE INFORMATION* for detailed information.

**ABSOLUTE MAXIMUM RATINGS**

Electronic and mechanical stress momentarily exceeded absolute maximum ratings may cause the permanent damages and may degrade the lifetime and safety for both device and system using the device in the field. The functional operation at or over these absolute maximum ratings are not assured.

**RECOMMENDED OPERATING CONDITIONS**

Symbol	Item	Rating	Unit
V <sub>IN</sub>	Input Voltage	3.5 to 36	V
T <sub>a</sub>	Operating Temperature Range	-40 to 125	°C

**RECOMMENDED OPERATING CONDITIONS**

All of electronic equipment should be designed that the mounted semiconductor devices operate within the recommended operating conditions. The semiconductor devices cannot operate normally over the recommended operating conditions, even if when they are used over such conditions by momentary electronic noise or surge. And the semiconductor devices may receive serious damage when they continue to operate over the recommended operating conditions.

## ELECTRICAL CHARACTERISTICS

$C_{IN} = C_{OUT} = 0.1 \mu\text{F}$ , unless otherwise noted.

## R8160xxxxB

( $-40^{\circ}\text{C} \leq T_a \leq 125^{\circ}\text{C}$ )

Symbol	Item	Conditions	Min.	Typ.	Max.	Unit	
$I_{SS}$	Supply Current	$V_{IN} = 14 \text{ V}$ $I_{OUT} = 0 \text{ mA}$	$V_{SET} \leq 5.0 \text{ V}$		2.2	6.5	$\mu\text{A}$
			$5.0 \text{ V} < V_{SET}$		2.5	6.8	
$I_{standby}$	Standby Current	$V_{IN} = 36 \text{ V}, V_{CE} = 0 \text{ V}$		0.1	1.0	$\mu\text{A}$	
$V_{OUT}$	Output Voltage	$V_{SET} + 1 \text{ V} \leq V_{IN} \leq 36 \text{ V}$ $I_{OUT} = 1 \text{ mA}$	$T_a = 25^{\circ}\text{C}$	$\times 0.994$		$\times 1.006$	V
			$-40^{\circ}\text{C} \leq T_a \leq 125^{\circ}\text{C}$	$\times 0.984$		$\times 1.016$	
$\frac{\Delta V_{OUT}}{\Delta I_{OUT}}$	Load Regulation	$V_{IN} = V_{SET} + 3.0 \text{ V}$ $1 \text{ mA} \leq I_{OUT} \leq 200 \text{ mA}$	Refer to the <i>Product-specific Electrical Characteristics</i>			mV	
$\frac{\Delta V_{OUT}}{\Delta V_{IN}}$	Line Regulation	$V_{SET} + 1 \text{ V} \leq V_{IN} \leq 36 \text{ V}, I_{OUT} = 1 \text{ mA}$	-0.02	0.01	0.02	%/V	
$V_{DIF}$	Dropout Voltage	$I_{OUT} = 200 \text{ mA}$	Refer to the <i>Product-specific Electrical Characteristics</i>			V	
$I_{LIM}$	Output Current Limit	$V_{IN} = V_{SET} + 3.0 \text{ V}$	220	350	420	mA	
$I_{SC}$	Short Current Limit	$V_{IN} = 3.5 \text{ V}, V_{OUT} = 0 \text{ V}$	60	80	110	mA	
$V_{CEH}$	CE Input Voltage "H"		2.0		36	V	
$V_{CEL}$	CE Input Voltage "L"		0		1.0	V	
$I_{PD}$	CE Pull-down Current	$V_{CE} = 2 \text{ V}$		0.2	0.6	$\mu\text{A}$	
$T_{TSD}$	Thermal Shutdown Temperature	Junction Temperature	150	160		$^{\circ}\text{C}$	
$T_{TSR}$	Thermal Shutdown Released Temperature	Junction Temperature	125	135		$^{\circ}\text{C}$	

## R8160xxxxB Product-specific Electrical Characteristics

( $-40^{\circ}\text{C} \leq T_a \leq 125^{\circ}\text{C}$ )

Product Name	$V_{OUT} \text{ (V)}$ ( $T_a = 25^{\circ}\text{C}$ )			$V_{OUT} \text{ (V)}$ ( $-40^{\circ}\text{C} \leq T_a \leq 125^{\circ}\text{C}$ )			$\Delta V_{OUT}/\Delta I_{OUT} \text{ (mV)}$			$V_{DIF} \text{ (V)}$	
	MIN.	TYP.	MAX.	MIN.	TYP.	MAX.	MIN.	TYP.	MAX.	TYP.	MAX.
R8160x033B	3.2802	3.30	3.3198	3.2472	3.30	3.3528	-10	10	40	0.8	2.0
R8160x034B	3.3796	3.40	3.4204	3.3456	3.40	3.4544					
R8160x050B	4.9700	5.00	5.0300	4.9200	5.00	5.0800				-18	18
R8160x060B	5.9640	6.00	6.0360	5.9040	6.00	6.0960					
R8160x080B	7.9520	8.00	8.0480	7.8720	8.00	8.1280					
R8160x085B	8.4490	8.50	8.5510	8.3640	8.50	8.6360	0.5	1.3			
R8160x090B	8.9460	9.00	9.0540	8.8560	9.00	9.1440					

## TYPICAL APPLICATIONS

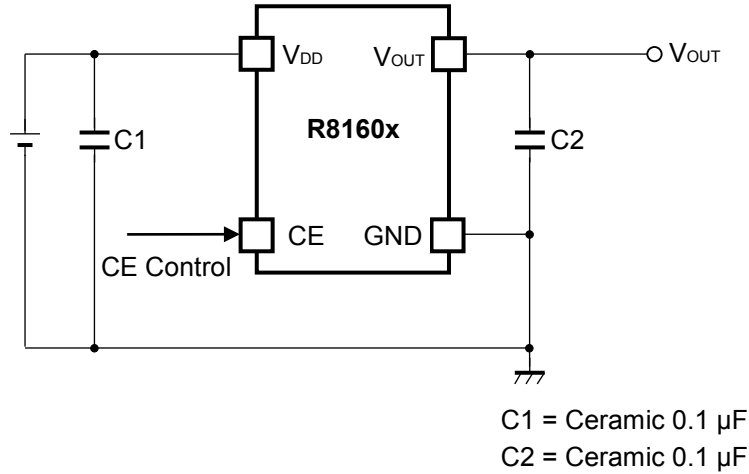

**R8160x Typical Applications**

## TECHNICAL NOTES

### Phase Compensation

In the R8160x, phase compensation is provided to secure stable operation even when the load current is varied. For this purpose, make sure to use 0.1  $\mu$ F or more of a capacitor (C2).

In case of using a tantalum type capacitor and the ESR (Equivalent Series Resistance) value of the capacitor is large, the output might be unstable. Evaluate the circuit including consideration of frequency characteristics.

Connect 0.1  $\mu$ F or more of a capacitor (C1) between  $V_{DD}$  and GND, and as close as possible to the pins.

### PCB Layout

For SOT-23-5 package type, wire the following GND pins together: No. 1 and No. 2

For SOT-89-5 package type, wire the following GND pins together: No. 2 and No. 4.

For HSOP-6J package type, wire the following GND pins together: No. 2, No. 4, and No. 5.

### Thermal Shutdown

R8160x has a built-in thermal shutdown circuit, which stops the regulator operation if the junction temperature of this device increases to 160°C (Typ.) or higher. If the temperature drops to 135°C (Typ.) or lower, the regulator restarts the operation. Unless eliminating the overheating problem, the regulator turns on and off repeatedly and as a result, a pulse shaped output voltage is generated.

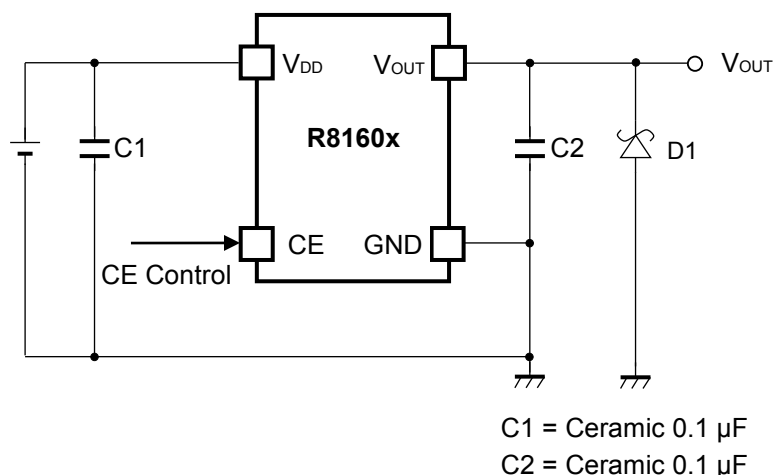
**TYPICAL APPLICATION FOR IC CHIP BREAKDOWN PREVENTION**

When a sudden surge of electrical current travels along the V<sub>OUT</sub> pin and GND due to a short-circuit, electrical resonance of a circuit involving an output capacitor (C2) and a short circuit inductor generates a negative voltage and may damage the device or the load devices. Connecting a schottky diode (D1) between the V<sub>OUT</sub> pin and GND has the effect of preventing damage to them.

**PACKAGE INFORMATION**

**POWER DISSIPATION (SOT-23-5)**

Power Dissipation ( $P_D$ ) depends on conditions of mounting on board. This specification is based on the measurement at the condition below:

Measurement Conditions

	Standard Test Land Pattern
Environment	Mounting on Board (Wind velocity = 0 m/s)
Board Material	Glass cloth epoxy plastic (Double sided)
Board Dimensions	40 mm x 40 mm x 1.6 mm
Copper Ratio	Top side: Approx. 50%, Back side: Approx. 50%
Through-holes	$\phi$ 0.5 mm x 44 pcs

Measurement Result:

( $T_a = 25^\circ\text{C}$ ,  $T_{jmax} = 150^\circ\text{C}$ )

	Standard Test Land Pattern	Free Air
Power Dissipation	525 mW	310 mW
Thermal Resistance	$\theta_{ja} = (150 - 25^\circ\text{C})/0.525 \text{ W} = 238^\circ\text{C/W}$	$400^\circ\text{C/W}$

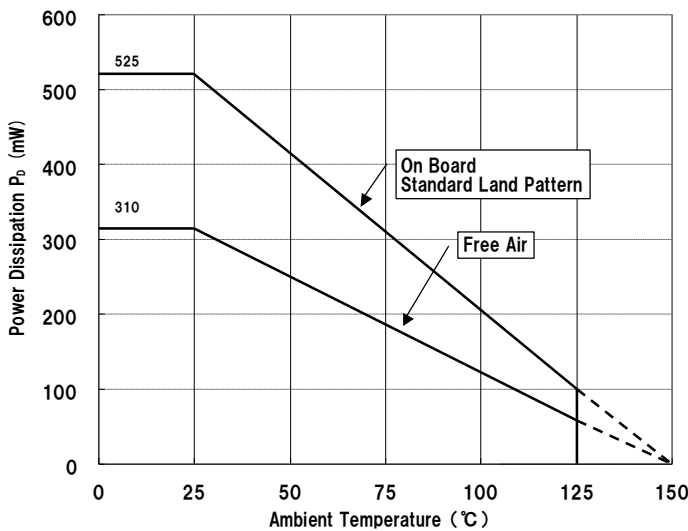

**Ambient Temperature vs. Power Dissipation**

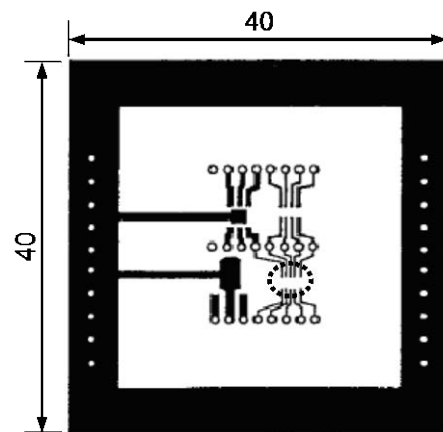

IC Mount Area (Unit: mm)

**Measurement Board Pattern**



**PACKAGE DIMENSIONS (SOT-23-5)**

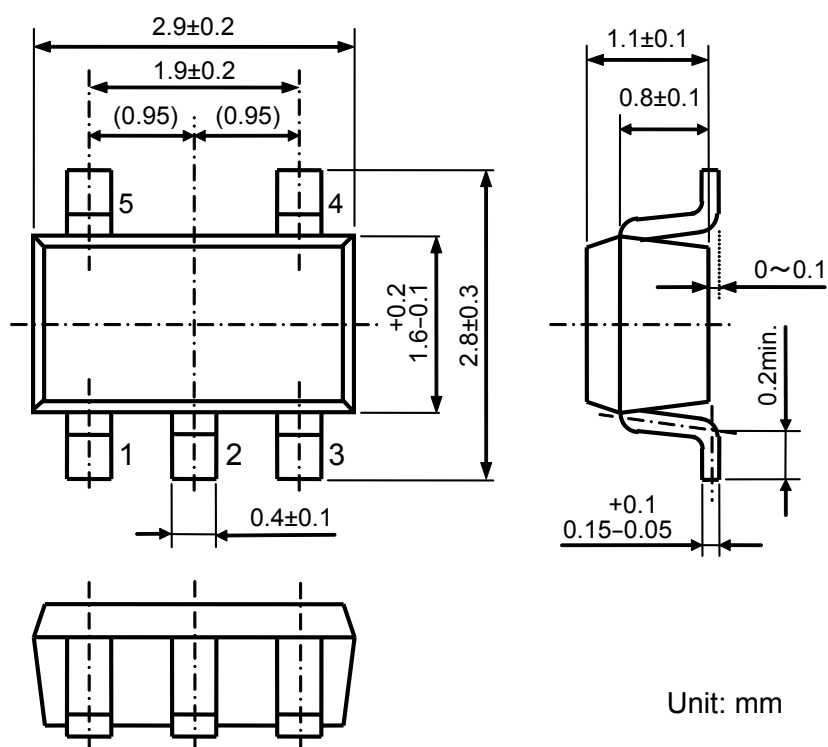

Unit: mm

**SOT-23-5 Package Dimensions**

**MARK SPECIFICATION (SOT-23-5)**

- ①②: Product Code ... **Refer to MARK SPECIFICATION TABLE (SOT-23-5)**
- ③④⑤: Lot Number ... Alphanumeric Serial Number
- ⑤: : Lot Sub Number ... Alphanumeric Serial Number

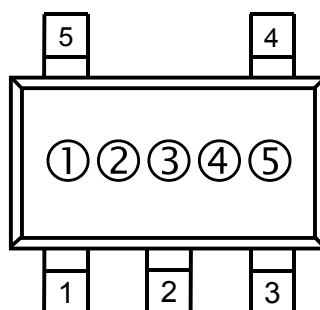

**SOT-23-5 Mark Specification**

---

**R8160x**NO.EC-348-160930

---

**MARK SPECIFICATION TABLE (SOT-23-5)****R8160NxxxB**

<b>Product Name</b>	<b>①</b>	<b>②</b>	<b>V<sub>SET</sub></b>
R8160N033B	A	0	3.3 V
R8160N034B	A	1	3.4 V
R8160N050B	A	2	5.0 V
R8160N060B	A	3	6.0 V
R8160N080B	A	4	8.0 V
R8160N085B	A	5	8.5 V
R8160N090B	A	6	9.0 V

**POWER DISSIPATION (SOT-89-5)**

Power Dissipation ( $P_D$ ) depends on conditions of mounting on board. This specification is based on the measurement at the condition below:

Measurement Conditions

	High Wattage Land Pattern	Standard Land Pattern
Environment	Mounting on Board (Wind velocity = 0 m/s)	Mounting on Board (Wind velocity = 0 m/s)
Board Material	Glass cloth epoxy plastic (Double sided)	Glass cloth epoxy plastic (Double sided)
Board Dimensions	30 mm × 30 mm × 1.6 mm	50 mm × 50 mm × 1.6 mm
Copper Ratio	Top side : Approx. 20% , Back side : Approx. 100%	Top side : Approx. 10% , Back side : Approx. 100%
Through-hole	φ0.85 mm × 10 pcs	-

Measurement Result

( $T_a = 25^\circ\text{C}$ ,  $T_{j\text{max}} = 150^\circ\text{C}$ )

	High Wattage Land Pattern	Standard Land Pattern	Free Air
Power Dissipation	1620 mW	1120 mW	620 mW
Thermal Resistance	77°C/W	111°C/W	200°C/W

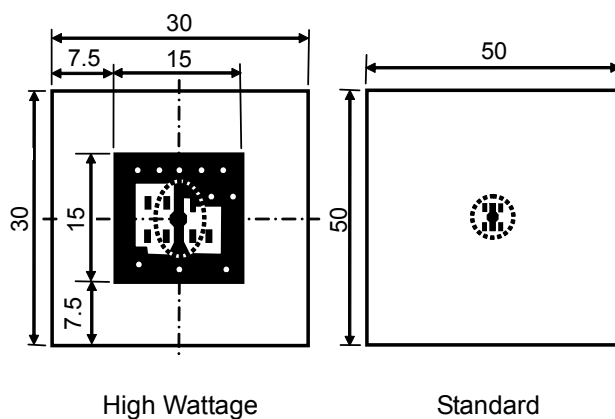
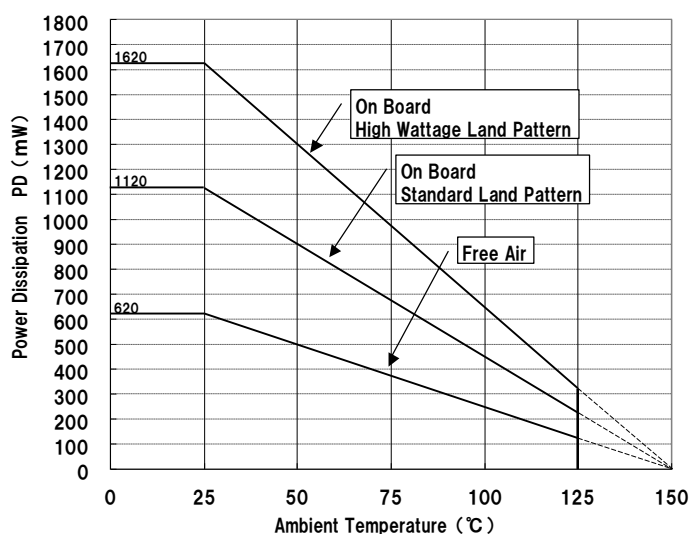

○ IC Mount Area (Unit: mm)

Measurement Board Pattern

Power Dissipation vs. Ambient Temperature

PACKAGE DIMENSIONS (SOT-89-5)

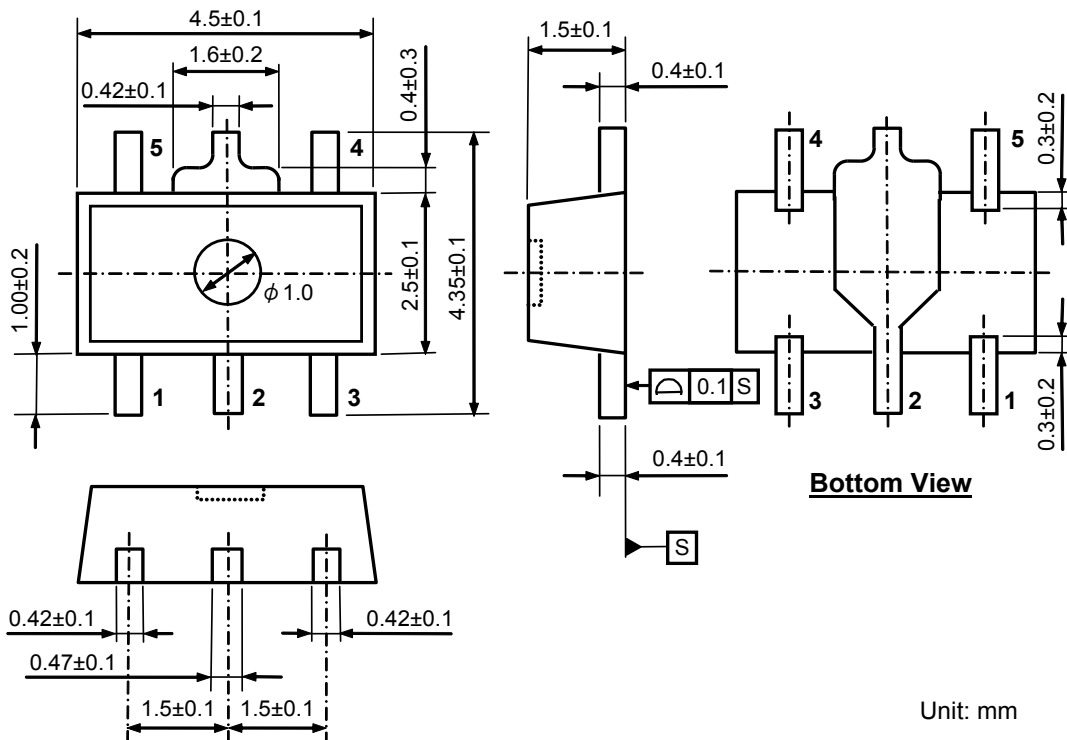

Unit: mm

SOT-89-5 Package Dimensions

MARK SPECIFICATION (SOT-89-5)

- ①②③④: Product Code ... **Refer to MARK SPECIFICATION TABLE (SOT-89-5)**
- ⑤⑥⑦⑧: Lot Number ... Alphanumeric Serial Number
- ⑨: Lot Sub Number ... Alphanumeric Serial Number

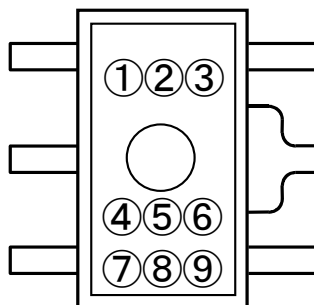

SOT-89-5 Mark Specification

**MARK SPECIFICATION TABLE (SOT-89-5)****R8160HxxxB**

<b>Product Name</b>	<b>①</b>	<b>②</b>	<b>③</b>	<b>④</b>	<b>V<sub>SET</sub></b>
R8160H033B	K	3	3	B	3.3 V
R8160H034B	K	3	4	B	3.4 V
R8160H050B	K	5	0	B	5.0 V
R8160H060B	K	6	0	B	6.0 V
R8160H080B	K	8	0	B	8.0 V
R8160H085B	K	8	5	B	8.5 V
R8160H090B	K	9	0	B	9.0 V

**R8160x**

NO.EC-348-160930

**POWER DISSIPATION (HSOP-6J)**

The power dissipation of the package is dependent on PCB material, layout, and environmental conditions. The following conditions are used in this measurement.

**Measurement Conditions**

	<b>Ultra-high Wattage Land Pattern</b>	<b>Standard Land Pattern</b>
Environment	Mounting on Board (Wind Velocity = 0 m/s)	Mounting on Board (Wind Velocity = 0 m/s)
Board Material	Glass Cloth Epoxy Plastic (Four-layer Board)	Glass Cloth Epoxy Plastic (Double-sided Board)
Board Dimensions	76.2 mm × 114.3 mm × 0.8 mm	50 mm × 50 mm × 1.6 mm
Copper Ratio	96%	50%
Through-holes	φ 0.3 mm × 28 pcs	φ 0.5 mm × 24 pcs

**Measurement Result**

(Ta = 25°C, Tjmax = 150°C)

	<b>Ultra-high Wattage Land Pattern</b>	<b>Standard Land Pattern</b>	<b>Free Air</b>
Power Dissipation	3400 mW	2100 mW	675 mW
Thermal Resistance	37°C/W	59°C/W	185°C/W

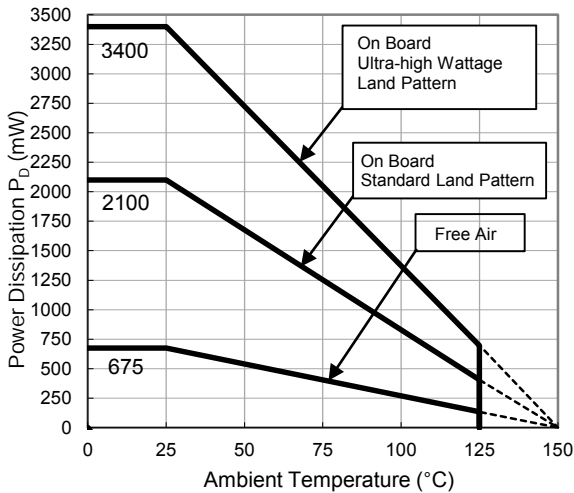

**Power Dissipation vs. Ambient Temperature**

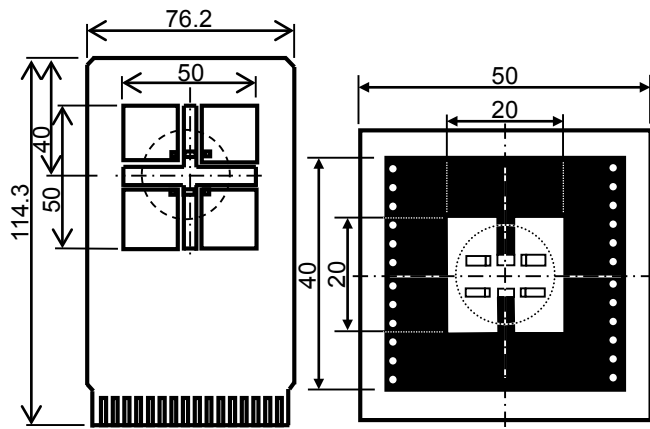

**Ultra-high Wattage**

**Standard**

○ IC Mount Area (mm)

**Measurement Board Pattern**

**PACKAGE DIMENSIONS (HSOP-6J)**

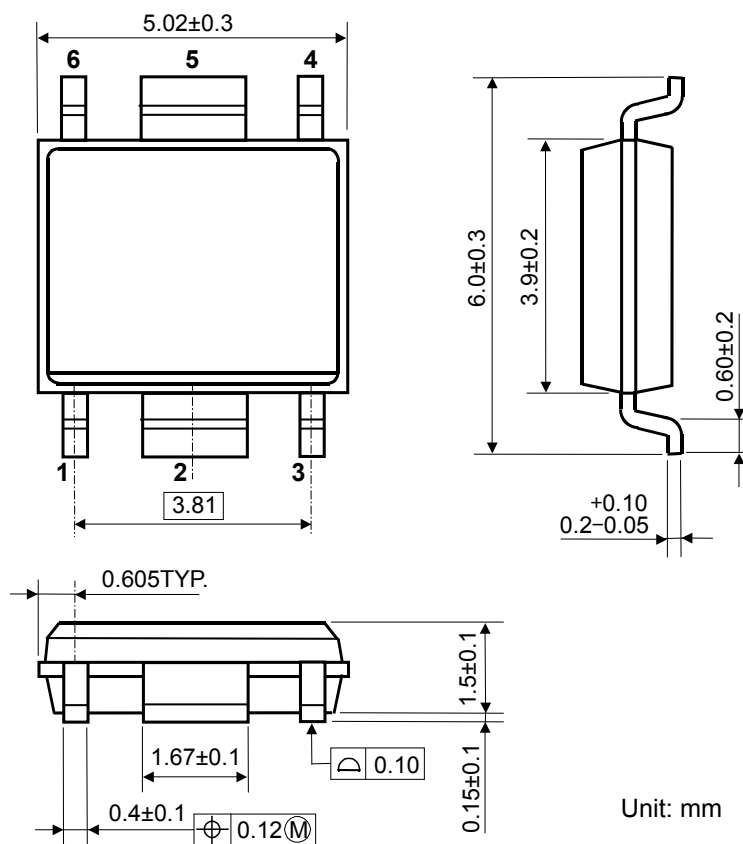

**HSOP-6J Package Dimensions**

**MARK SPECIFICATION (HSOP-6J)**

- ①②③④: Product Code ... **Refer to MARK SPECIFICATION TABLE (HSOP-6J)**
- ⑤⑥: Lot Number ... Alphanumeric Serial Number
- ⑦: Lot Sub Number ... Alphanumeric Serial Number

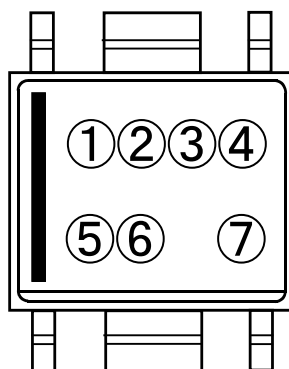

**HSOP-6J Mark Specification**

---

**R8160x**NO.EC-348-160930

---

**MARK SPECIFICATION TABLE (HSOP-6J)****R8160SxxxB**

<b>Product Name</b>	<b>①</b>	<b>②</b>	<b>③</b>	<b>④</b>	<b>V<sub>SET</sub></b>
R8160S033B	B	3	3	B	3.3 V
R8160S034B	B	3	4	B	3.4 V
R8160S050B	B	5	0	B	5.0 V
R8160S060B	B	6	0	B	6.0 V
R8160S080B	B	8	0	B	8.0 V
R8160S085B	B	8	5	B	8.5 V
R8160S090B	B	9	0	B	9.0 V



## TYPICAL CHARACTERISTICS

Note: Typical Characteristics are intended to be used as reference data; they are not guaranteed.

### 1) Output Voltage vs. Output Current (Ta = 25°C)

R8160x033B

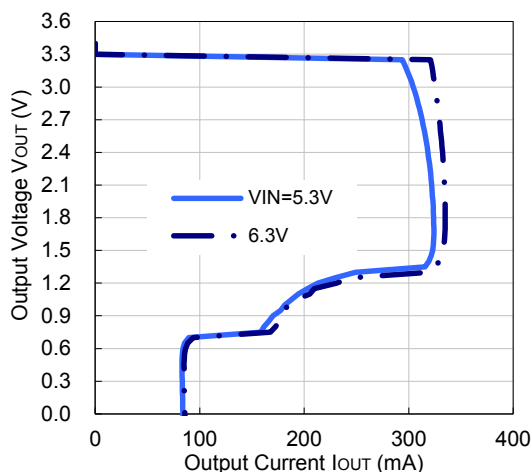

R8160x050B

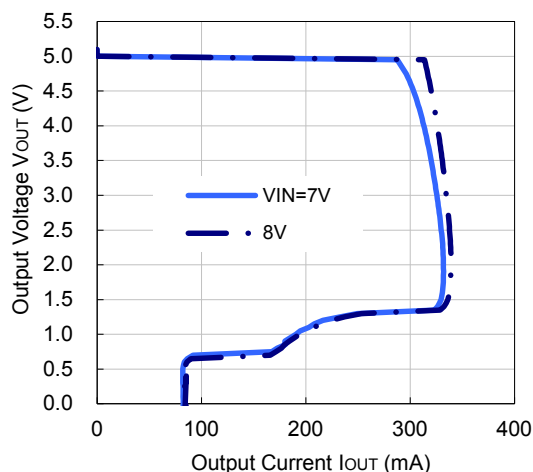

R8160x090B

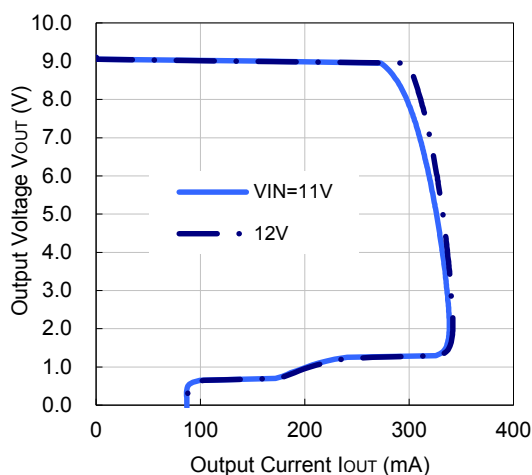

### 2) Output Voltage vs. Input Voltage (Ta = 25°C)

R8160x033B

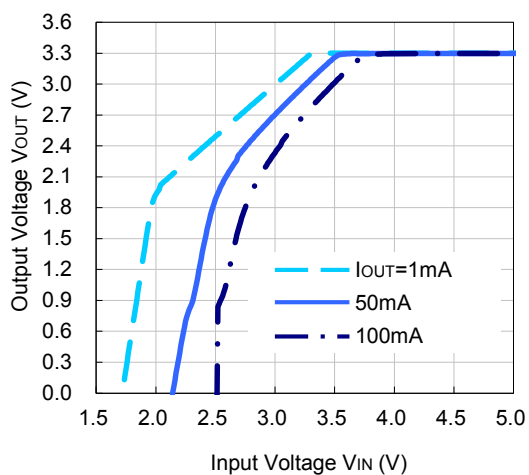

R8160x050B

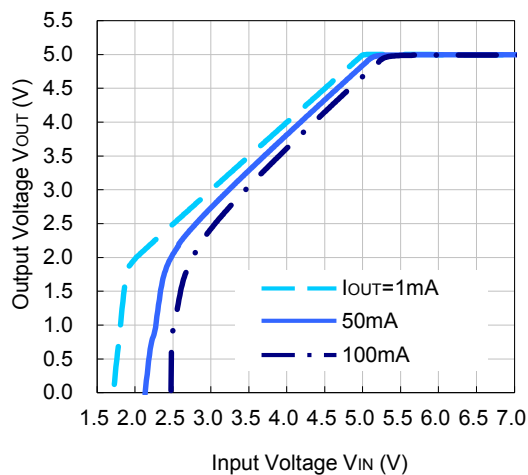

**R8160x090B**

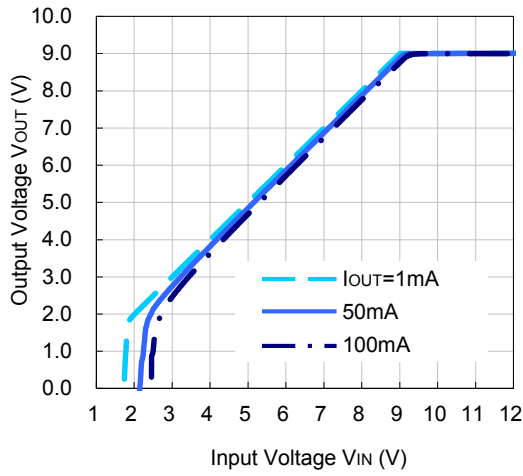

**3) Supply Current vs. Temperature**

**R8160x033B**

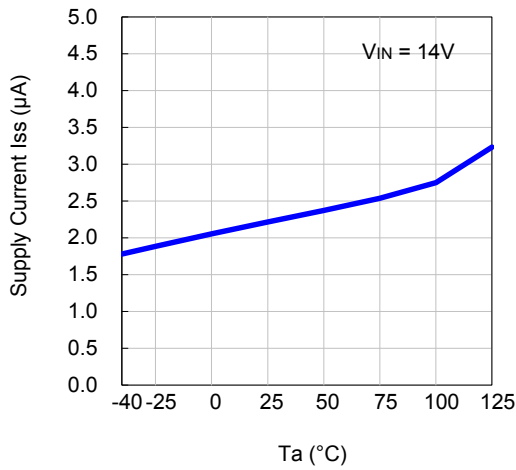

**R8160x050B**

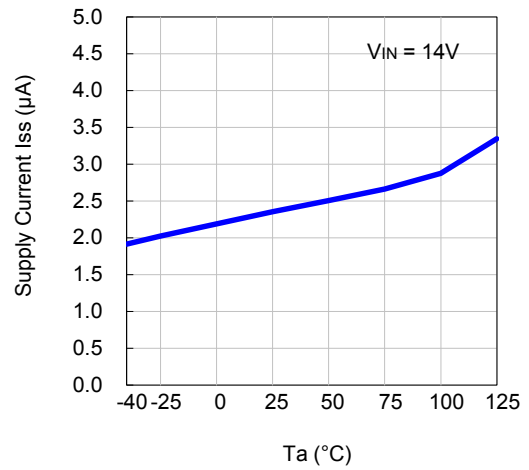

**R8160x090B**

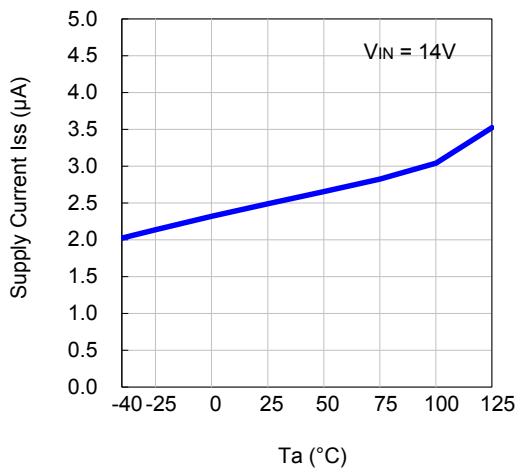

**4) Supply Current vs. Input Voltage (R8160x033B)**

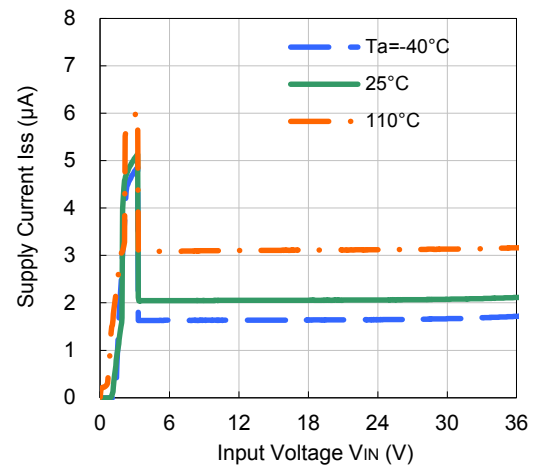

5) Output Voltage vs. Temperature ( $I_{OUT} = 1mA$ )

R8160x033B

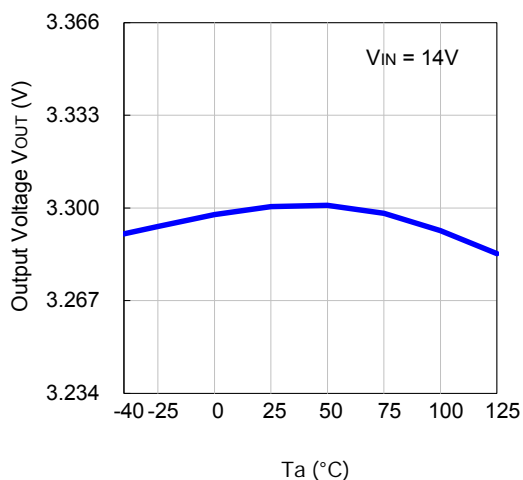

R8160x050B

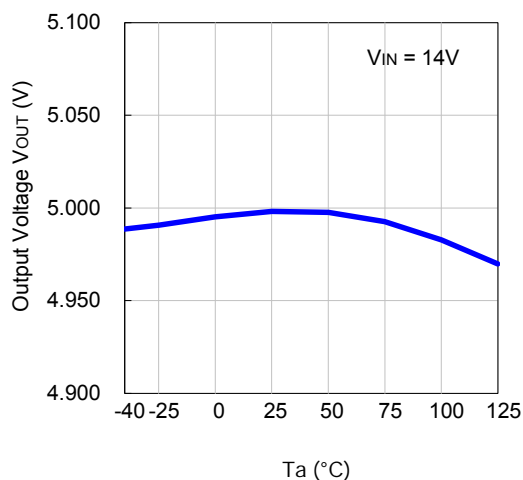

R8160x090B

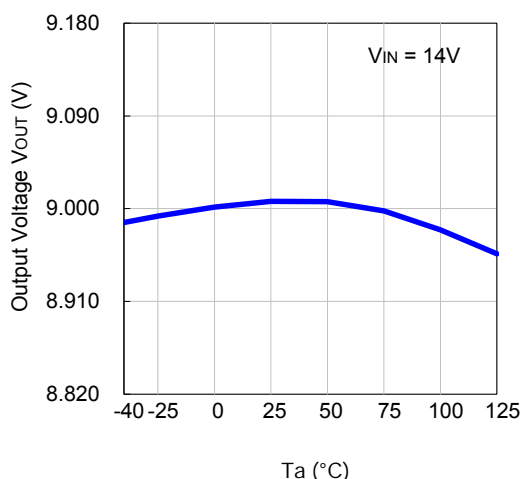

6) Dropout Voltage vs. Output Current

R8160x033B

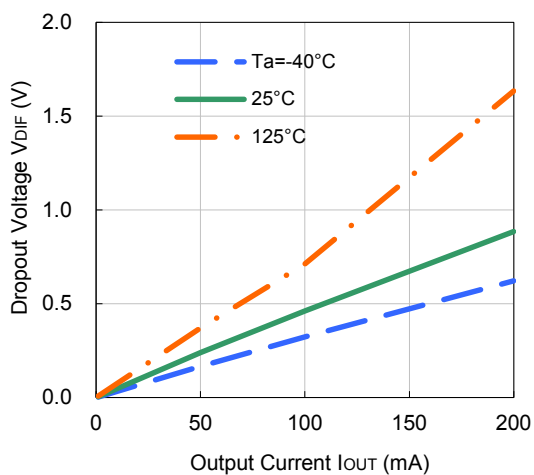

R8160x050B

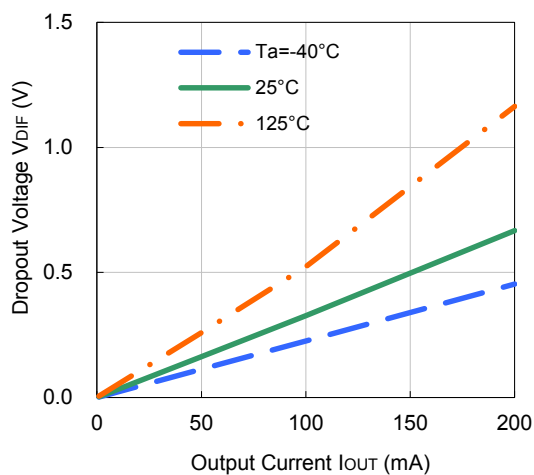

**R8160x090B**

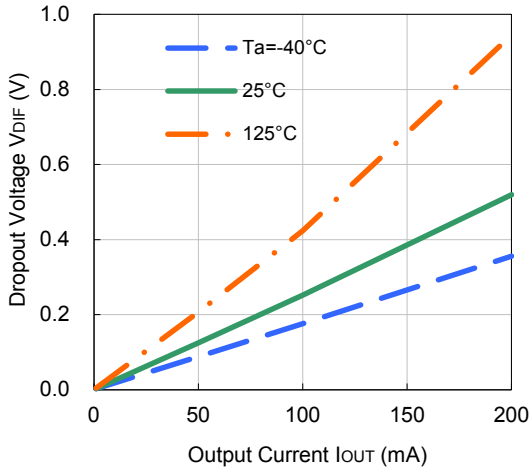

**7) Dropout Voltage vs. Output Voltage ( $T_a = 25^\circ\text{C}$ )**

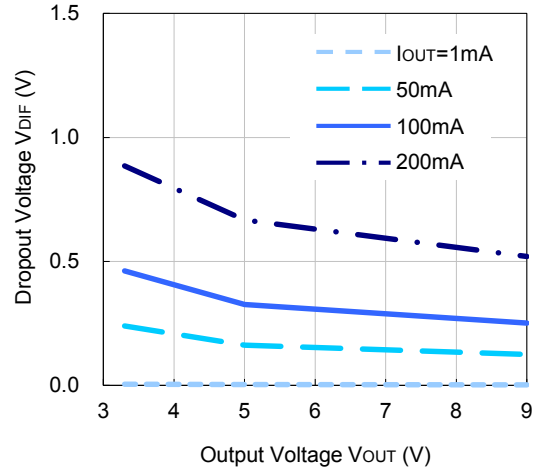

**8) Ripple Rejection vs. Input Voltage ( $T_a = 25^\circ\text{C}$ , Ripple = 0.2 Vpp)**

**R8160x033B**

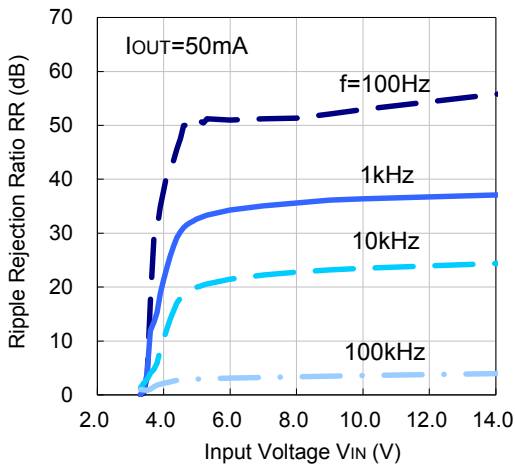

**R8160x050B**

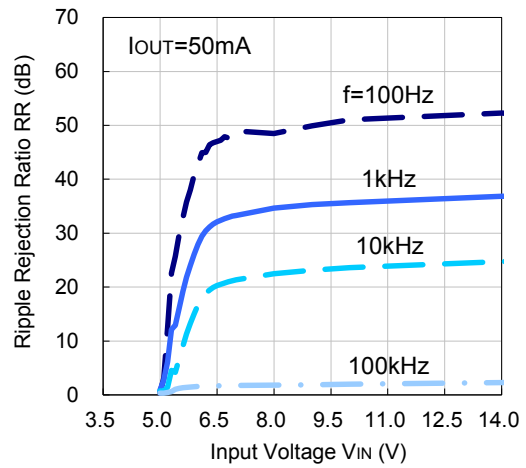

**R8160x090B**

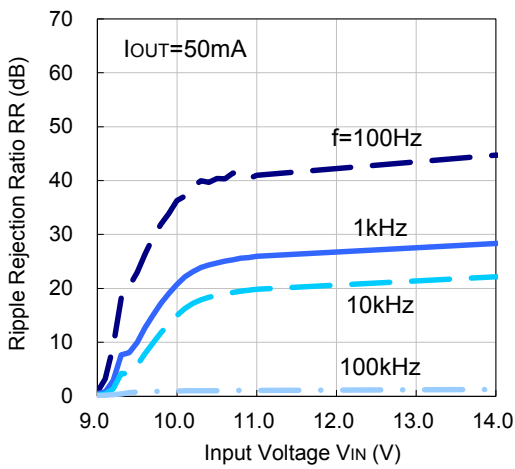

9) Ripple Rejection vs. Frequency ( $T_a = 25^\circ\text{C}$ , Ripple = 0.2 Vpp)

R8160x033B

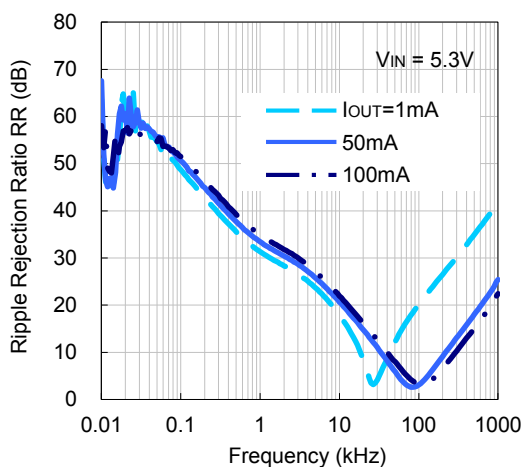

R8160x050B

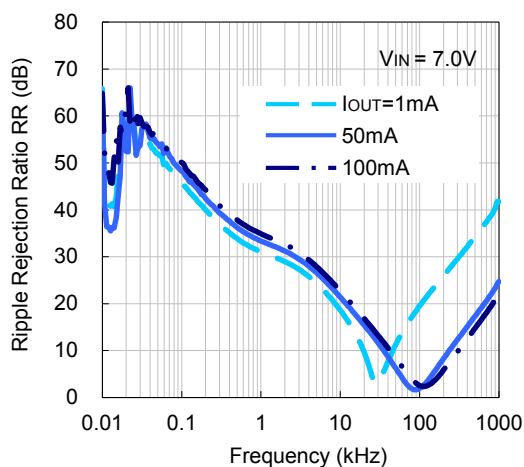

R8160x090B

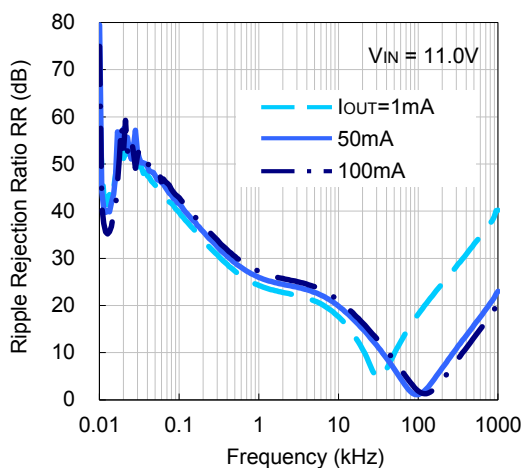

10) Input Transient Response ( $T_a = 25^\circ\text{C}$ )

R8160x033B

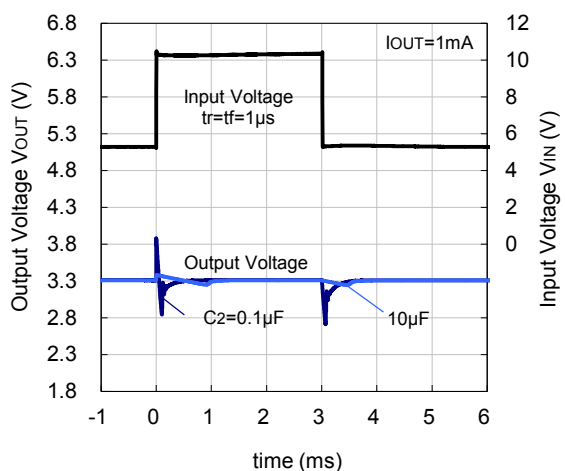

R8160x050B

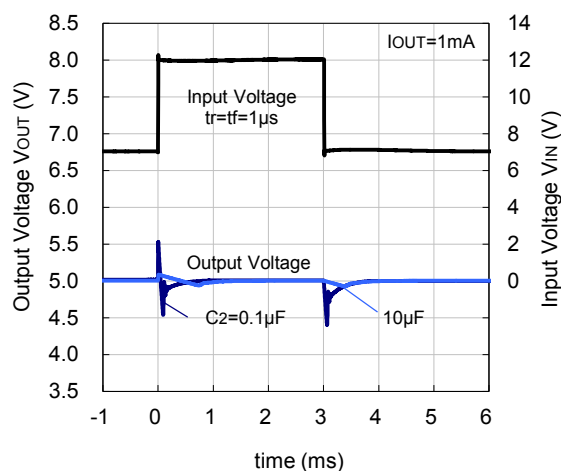

# R8160x

NO.EC-348-160930

## R8160x090B

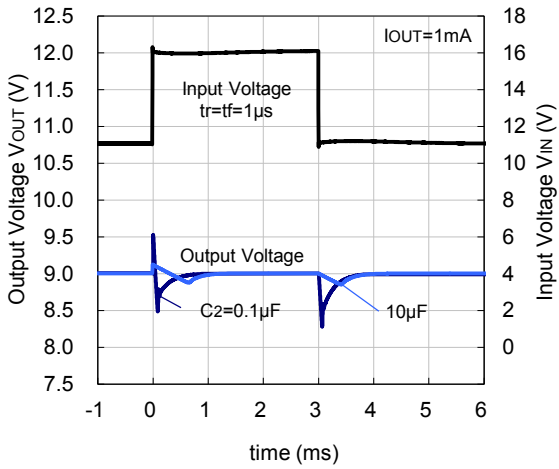

### 11) Load Transient Response ( $T_a = 25^\circ C$ )

#### R8160x033B

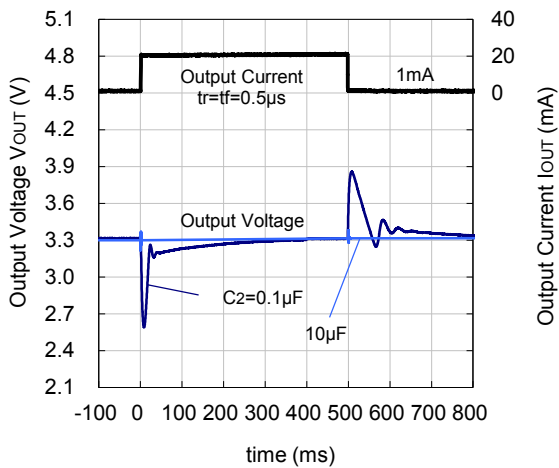

#### R8160x050B

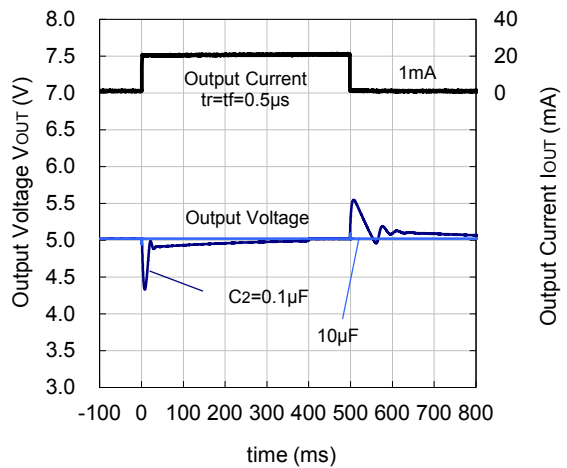

#### R8160x090B

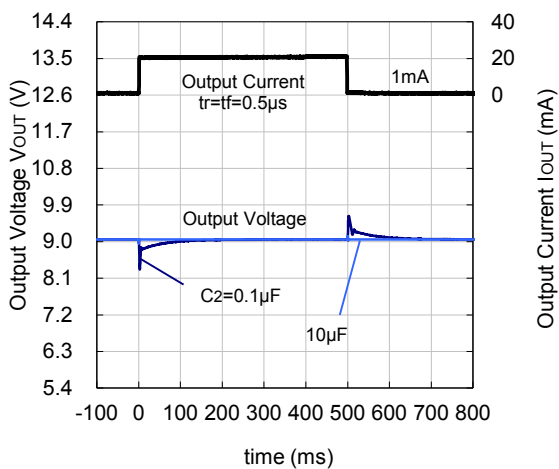

12) CE Transient Response (Ta = 25°C)

R8160x033B

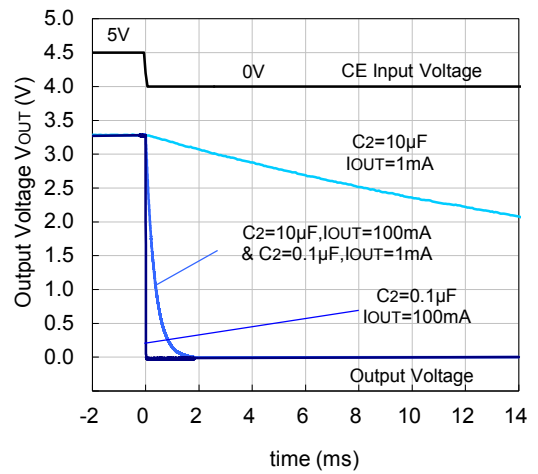
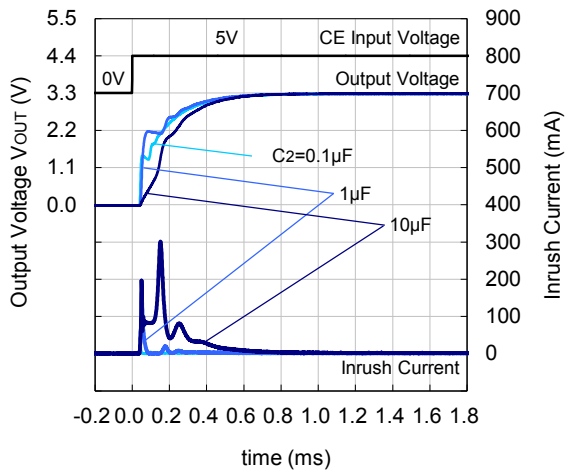

R8160x050B

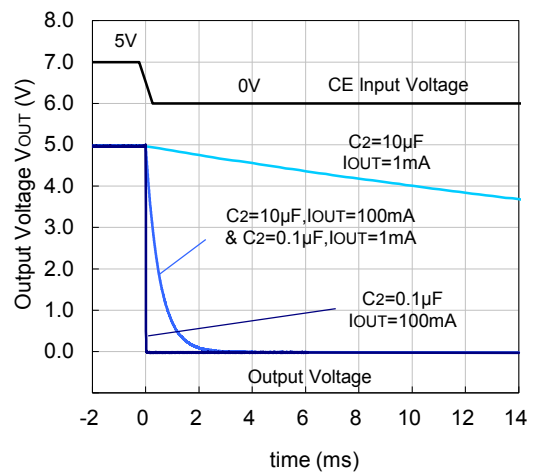
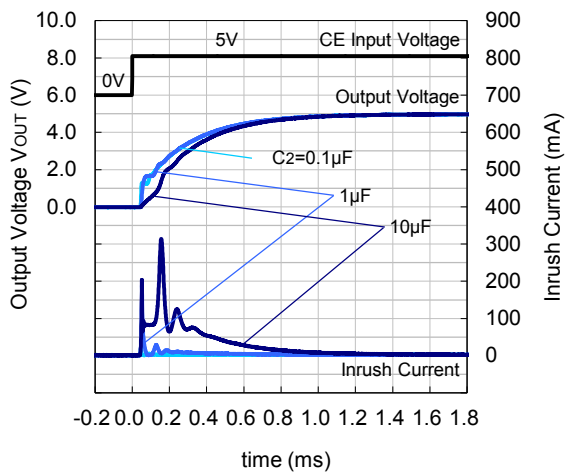

R8160x090B

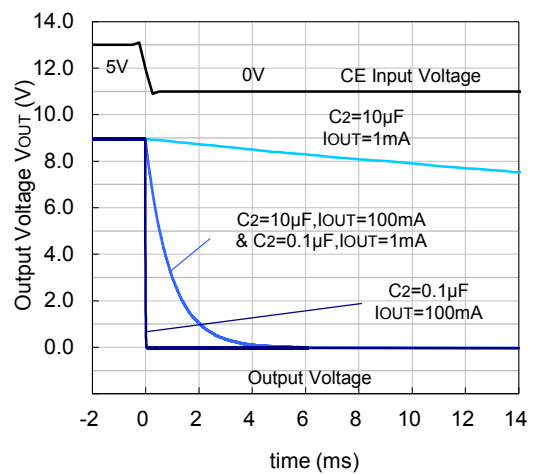
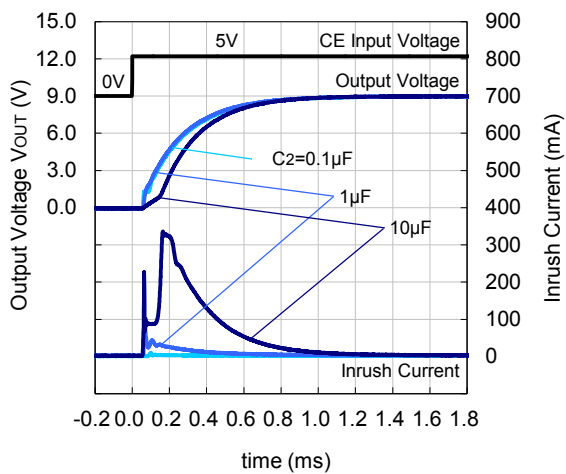

# R8160x

NO.EC-348-160930

## 13) Power-on Transient Response ( $T_a = 25^\circ\text{C}$ , $V_{CE} = 5\text{ V}$ )

### R8160x033B

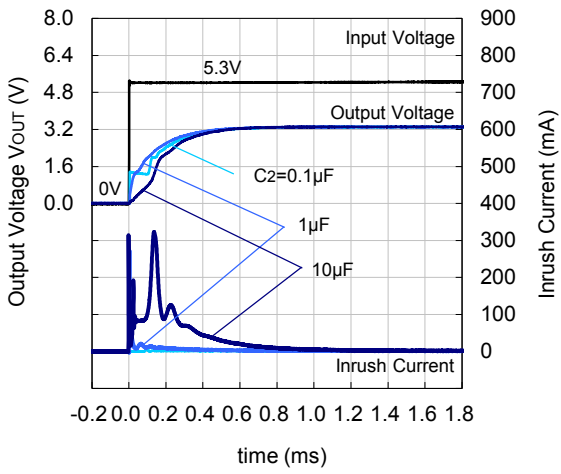

### R8160x050B

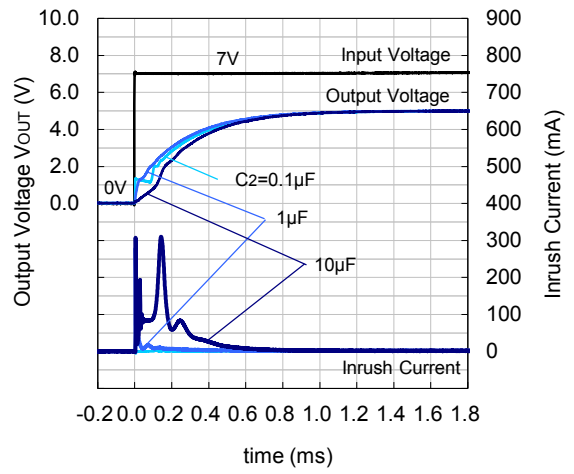

### R8160x090B

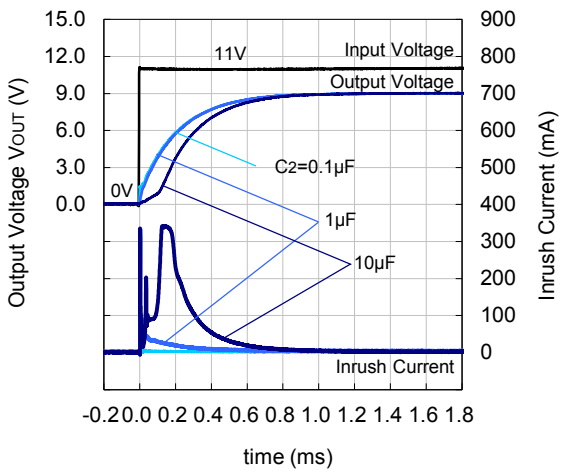



14) Load Dump (Ta = 25°C)

R8160x033B

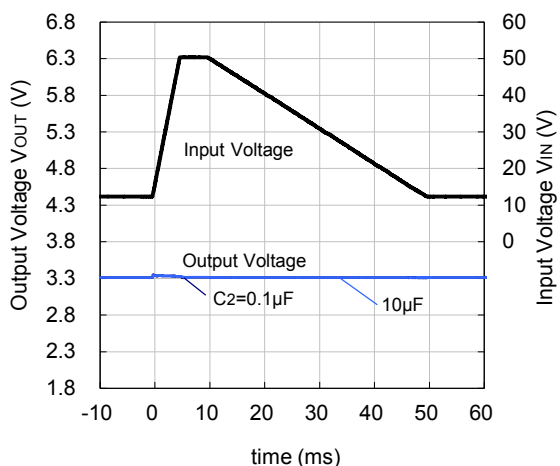

R8160x050B

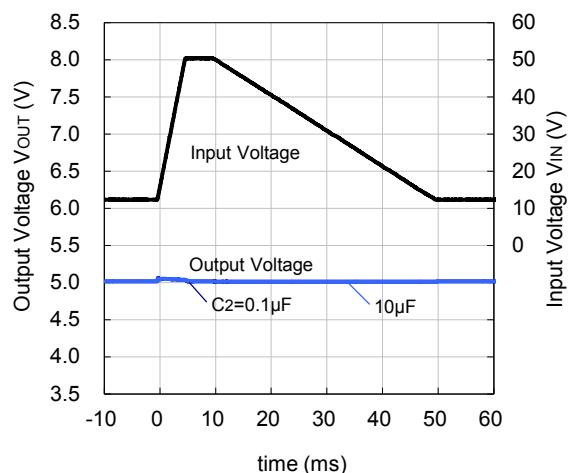

R8160x090B

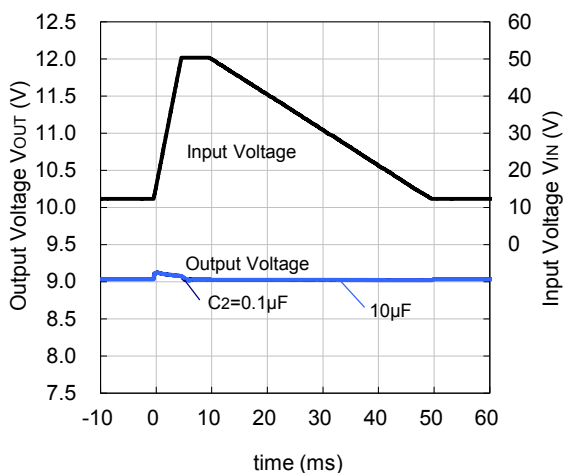

15) Cranking (Ta = 25°C)

R8160x050B

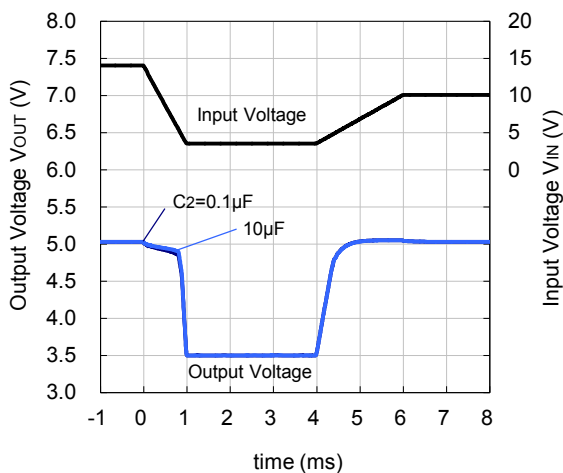

R8160x090B

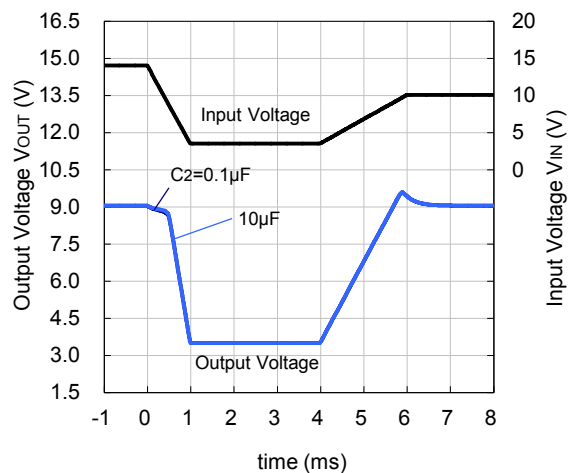

**Input Transient/Load Transient vs. Output Capacity (C2)**

R8160 performs a stable operation by using 0.1  $\mu\text{F}$  of ceramic capacitor as the output capacitor. However, the variation of output voltage may not meet the demand of the system when input voltage and load current vary. In such cases, the variation of output voltage can be minimized significantly by using 10  $\mu\text{F}$  or higher ceramic capacitor. When using a high-capacity electrolytic capacitor for the output line, place the electrolytic capacitor a few centimeters apart from the IC after arranging the ceramic capacitor close to the IC.

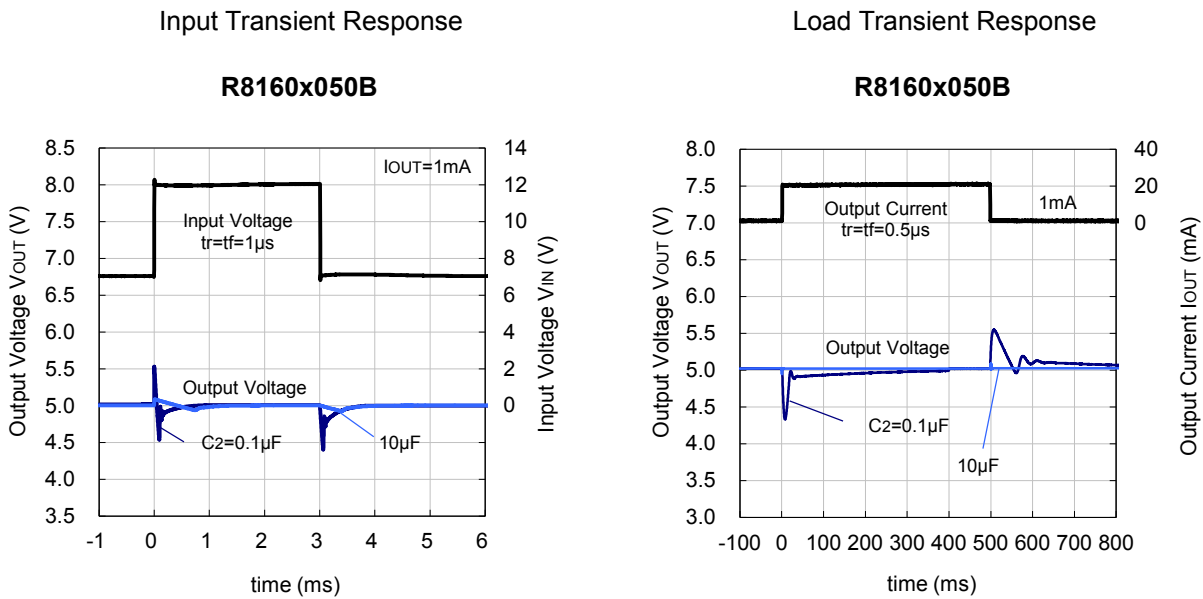

## ESR vs. Output Current

It is recommended that a ceramic type capacitor be used for this device. However, other types of capacitors having lower ESR can also be used. The relation between the output current ( $I_{OUT}$ ) and the ESR of output capacitor is shown below.

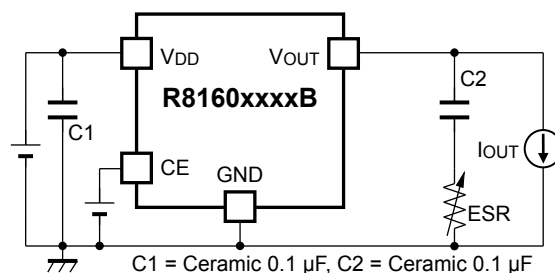

### Measurement Conditions

Frequency Band: 10 Hz to 2 MHz

Measurement Temperature:  $-40^{\circ}\text{C}$  to  $125^{\circ}\text{C}$

Hatched area: Noise level is 40  $\mu\text{V}$  (average) or below

Ceramic Capacitors: C1 = 0.1  $\mu\text{F}$ , C2 = 0.1  $\mu\text{F}$

#### R8160x033B

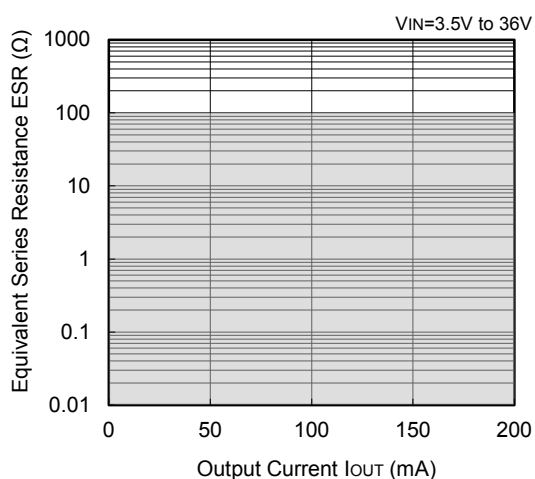

#### R8160x050B

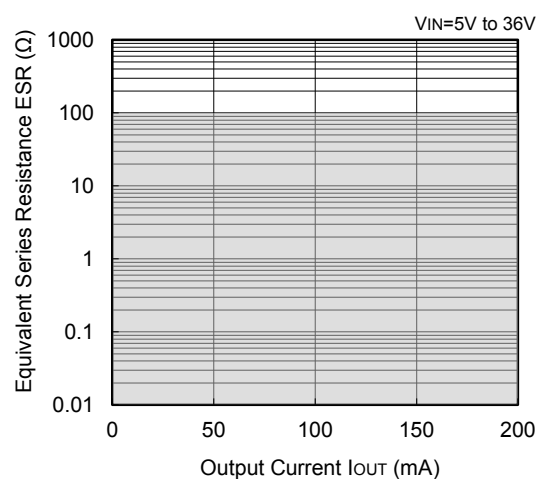

#### R8160x090B

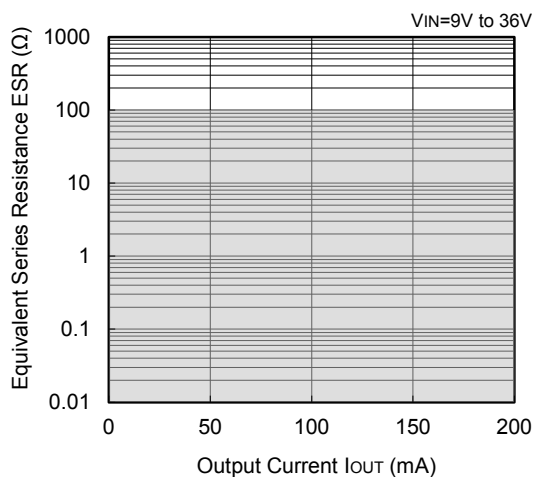



1. The products and the product specifications described in this document are subject to change or discontinuation of production without notice for reasons such as improvement. Therefore, before deciding to use the products, please refer to our sales representatives for the latest information thereon.
2. The materials in this document may not be copied or otherwise reproduced in whole or in part without prior written consent of our company.
3. Please be sure to take any necessary formalities under relevant laws or regulations before exporting or otherwise taking out of your country the products or the technical information described herein.
4. The technical information described in this document shows typical characteristics of and example application circuits for the products. The release of such information is not to be construed as a warranty of or a grant of license under our company's or any third party's intellectual property rights or any other rights.
5. The products in this document are designed for automotive applications. However, when using the products for automotive applications, please make sure to contact our sales representative in advance due to confirming the quality level.
6. We are making our continuous effort to improve the quality and reliability of our products, but semiconductor products are likely to fail with certain probability. In order to prevent any injury to persons or damages to property resulting from such failure, customers should be careful enough to incorporate safety measures in their design, such as redundancy feature, fire containment feature and fail-safe feature. We do not assume any liability or responsibility for any loss or damage arising from misuse or inappropriate use of the products.
7. Anti-radiation design is not implemented in the products described in this document.
8. The X-ray exposure can influence functions and characteristics of the products. Confirm the product functions and characteristics in the evaluation stage.
9. WLCSP products should be used in light shielded environments. The light exposure can influence functions and characteristics of the products under operation or storage.
10. There can be variation in the marking when different AOI (Automated Optical Inspection) equipment is used. In the case of recognizing the marking characteristic with AOI, please contact our sales or our distributor before attempting to use AOI.
11. Please contact our sales representatives should you have any questions or comments concerning the products or the technical information.



**Nisshinbo Micro Devices Inc.**

**Official website**

<https://www.nisshinbo-microdevices.co.jp/en/>

**Purchase information**

<https://www.nisshinbo-microdevices.co.jp/en/buy/>

