

## 42 V Input Ultra Low Supply Current VR with RESET for Industrial Applications

No. EA-407-220325

### OUTLINE

R5112S is an ultra-low supply current voltage regulator with a voltage detector featuring 200 mA output current and 42 V input voltage. This device consists of an Output Short-circuit Protection Circuit, an Overcurrent Protection Circuit, and a Thermal Shutdown Circuit in addition to the basic regulator circuits. The operating temperature range is between  $-40^{\circ}\text{C}$  to  $125^{\circ}\text{C}$ , and the maximum input voltage is 42 V. The output voltages are internally fixed at either of the following: 1.8 V, 2.5 V, 2.8 V, 3.0 V, 3.3 V, 3.4 V, or 5.0 V. The output voltage accuracy is  $\pm 0.6\%$ . The detector threshold accuracy of the voltage detector is  $\pm 0.6\%$ . This device is offered in an 8-pin HSOP-8E package with high power dissipation.

This is a high-reliability semiconductor device for industrial application (-Y) that has passed both the screening at high temperature and the reliability test with extended hours.

### FEATURES

- Input Voltage Range (Maximum Rating)..... 3.5 V to 42 V (50 V)
- Operating Temperature Range.....  $-40^{\circ}\text{C}$  to  $125^{\circ}\text{C}$
- Supply Current..... Typ.  $3.8\ \mu\text{A}$
- Standby Current..... Typ.  $0.1\ \mu\text{A}$
- Dropout Voltage..... Typ. 0.6 V ( $I_{\text{OUT}} = 200\ \text{mA}$ ,  $V_{\text{SET}} = 5.0\ \text{V}$ )
- Output Voltage Range..... 1.8 V / 2.5 V / 2.8 V / 3.0 V / 3.3 V / 3.4 V / 5.0 V  
\*Contact sales representatives for other voltages.
- Output Voltage Accuracy.....  $\pm 0.6\%$  ( $T_a = 25^{\circ}\text{C}$ )
- Output Voltage Temperature-Drift Coefficient..... Typ.  $\pm 60\ \text{ppm}/^{\circ}\text{C}$
- Detector Threshold Range..... R5112Sxx1B: 1.6 V to 4.8 V  
R5112Sxx1D: 2.9 V to 4.8 V
- Detector Threshold Accuracy.....  $\pm 0.6\%$  ( $T_a = 25^{\circ}\text{C}$ )
- Detector Threshold Temperature Coefficient..... Typ.  $\pm 60\ \text{ppm}/^{\circ}\text{C}$
- Line Regulation..... Typ.  $0.01\%/V$  ( $2.5\ \text{V} \leq V_{\text{SET}}: V_{\text{SET}} + 1\ \text{V} \leq V_{\text{IN}} \leq 42\ \text{V}$ )
- Built-in Output Short-circuit Protection Circuit..... Typ. 80 mA
- Built-in Overcurrent Protection Circuit..... Typ. 350 mA
- Built-in Thermal Shutdown Circuit..... Thermal Shutdown Temperature: Typ.  $170^{\circ}\text{C}$
- Ceramic capacitors are recommended  
to be used with this device.....  $C_{\text{OUT}} = 0.1\ \mu\text{F}$  or more
- Package..... HSOP-8E

### APPLICATIONS

- Industrial equipments such as FAs and smart meters.
- Equipments used under high-temperature conditions such as surveillance camera and vending machine.
- Equipments accompanied by self-heating such as motor and lighting.

## SELECTION GUIDE

The set output voltage is user-selectable.

Product Name	Package	Quantity per Reel	Pb Free	Halogen Free
R5112Sxx1*-E2-YE	HSOP-8E	1,000 pcs	Yes	Yes

xx: Specify the set output voltage ( $V_{SET}$ ) and the set detector threshold ( $-V_{SET}$ ) by using serial numbers starting from 01.<sup>(1)</sup>

\*: Select the voltage detection type from the following

B: SENSE pin detection

D: VOUT pin detection

---

<sup>(1)</sup> The combinations of  $V_{SET}$  and  $-V_{SET}$  are the following three conditions.

SENSE pin detection:  $V_{SET} = 3.3\text{ V to }5.0\text{ V}$ ,  $-V_{SET} = 2.5\text{ V to }4.8\text{ V}$

SENSE pin detection:  $V_{SET} = 1.8\text{ V to }3.2\text{ V}$ ,  $-V_{SET} = 1.6\text{ V to }2.9\text{ V}$

VOUT pin detection:  $V_{SET} = 3.3\text{ V to }5.0\text{ V}$ ,  $-V_{SET} = 2.9\text{ V to }4.8\text{ V}$

---

### BLOCK DIAGRAMS

**R5112SxxxB  
(SENSE Pin Detection)**

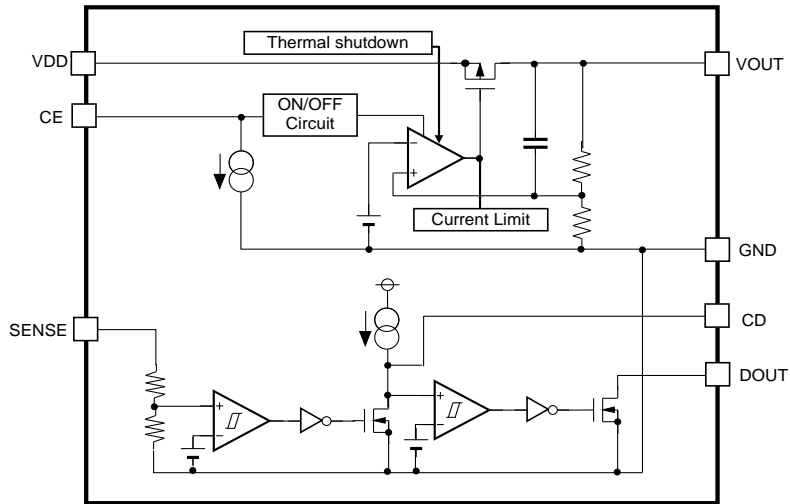

**R5112SxxxD  
(VOUT Pin Detection)**

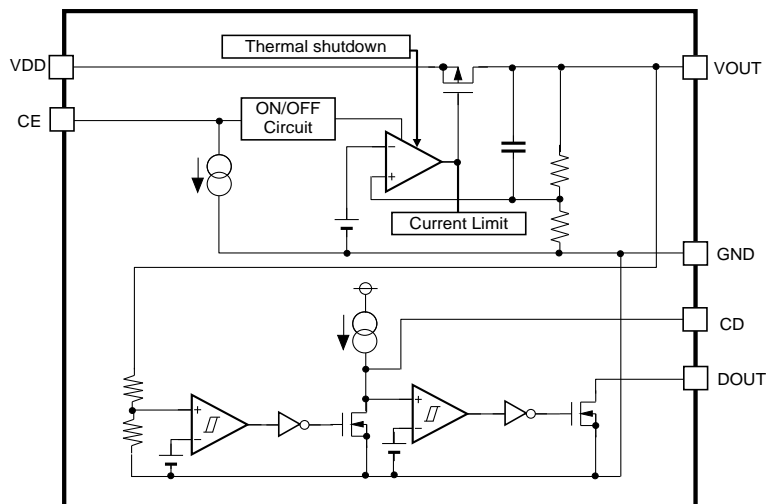

## PIN DESCRIPTIONS

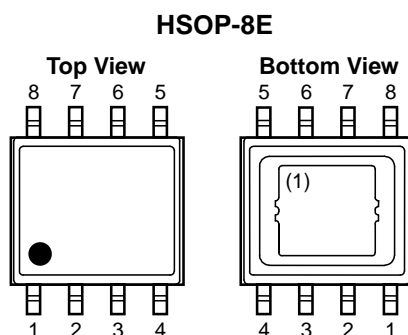

### HSOP-8E (R5112SxxxB/D)

Pin No.	Symbol	Description
1	VDD	Input Pin
2	CE	Chip Enable Pin (Active-high)
3	NC <sup>(3)</sup>	No Connection
4	DOUT <sup>(2)</sup>	VD Output Pin (Nch Open Drain)
5	CD	Pin for setting VD Release Output Delay Time (power-on reset time)
6	SENSE	VD Voltage SENSE Pin (R5112SxxxB)
	NC <sup>(3)</sup>	No Connection (R5112SxxxD)
7	GND	Ground Pin
8	VOUT	Output Pin

<sup>(1)</sup> The tab on the bottom of the package enhances thermal performance and is electrically connected to GND (substrate level). The tab is recommended to connect to the ground plane on the board. Otherwise it may be left floating.

<sup>(2)</sup> DOUT pin should be pulled-up to an external voltage level.

<sup>(3)</sup> NC pin is recommended to connect to the ground plane on the board. Otherwise it may be left floating

**PIN EQUIVALENT CIRCUIT DIAGRAMS**

**VOUT Pin**

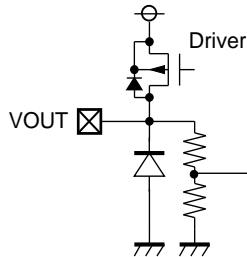

**CE Pin**

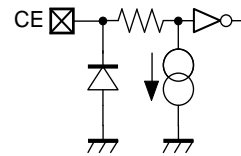

**CD Pin**

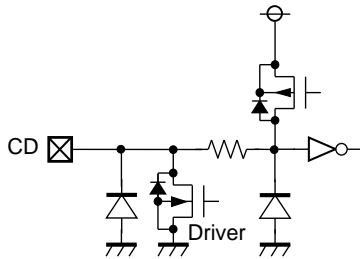

**DOUT Pin**

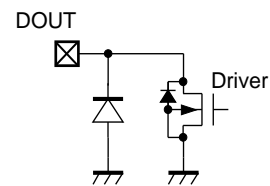

**SENSE Pin**

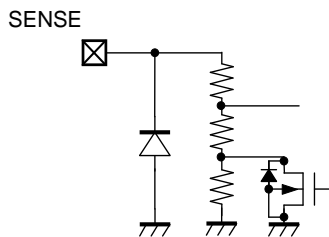

**ABSOLUTE MAXIMUM RATINGS**

Symbol	Item	Rating	Unit
V <sub>IN</sub>	Input Voltage	-0.3 to 50	V
	Peak Input Voltage <sup>(1)</sup>	60	V
V <sub>CE</sub>	Input Voltage (CE Pin)	-0.3 to 50	V
V <sub>OUT</sub>	Output Voltage	-0.3 to V <sub>IN</sub> + 0.3 ≤ 50	V
V <sub>CD</sub>	CD Pin Output Voltage	-0.3 to 7.0	V
V <sub>DOUT</sub>	DOUT Pin Output Voltage	-0.3 to 7.0	V
V <sub>SENSE</sub>	SENSE Pin Input Voltage	-0.3 to 7.0	V
I <sub>DOUT</sub>	DOUT Pin Current	16	mA
P <sub>D</sub>	Power Dissipation <sup>(2)</sup> (HSOP-8E, JEDEC STD. 51-7)	3600	mW
T <sub>j</sub>	Junction Temperature	-40 to 150	°C
T <sub>stg</sub>	Storage Temperature	-55 to 150	°C

**ABSOLUTE MAXIMUM RATINGS**

Electronic and mechanical stress momentarily exceeded absolute maximum ratings may cause permanent damage and may degrade the lifetime and safety for both device and system using the device in the field. The functional operation at or over these absolute maximum ratings are not assured.

**RECOMMENDED OPERATING CONDITIONS**

Symbol	Item	Rating	Unit
V <sub>IN</sub>	Input Voltage	3.5 to 42	V
V <sub>CE</sub>	Input Voltage (CE Pin)	0 to 42	V
V <sub>DOUT</sub>	DOUT Pin Output Voltage	0 to 5.5	V
V <sub>SENSE</sub>	SENSE Pin Input Voltage	0 to 5.5	V
T <sub>a</sub>	Operating Temperature	-40 to 125	°C

**RECOMMENDED OPERATING CONDITIONS**

All of electronic equipment should be designed that the mounted semiconductor devices operate within the recommended operating conditions. The semiconductor devices cannot operate normally over the recommended operating conditions, even if they are used over such conditions by momentary electronic noise or surge. And the semiconductor devices may receive serious damage when they continue to operate over the recommended operating conditions.

<sup>(1)</sup> Duration time: 200 ms

<sup>(2)</sup> Refer to *POWER DISSIPATION* for detailed information.

## ELECTRICAL CHARACTERISTICS

$C_{IN} = C_{OUT} = 0.1 \mu\text{F}$ ,  $V_{IN} = 14 \text{ V}$ , unless otherwise noted.

The specifications surrounded by  $\square$  are guaranteed by design engineering at  $-40^\circ\text{C} \leq T_a \leq 125^\circ\text{C}$ .

### R5112Sxxxx-YE

#### For All

( $T_a = 25^\circ\text{C}$ )

Symbol	Item	Conditions	Min.	Typ.	Max.	Unit
$I_{SS}$	Supply Current	$I_{OUT} = 0 \text{ mA}$		3.8	$\square 9.8$	$\mu\text{A}$
$I_{standby}$	Standby Current	$V_{IN} = 42 \text{ V}$ , $V_{CE} = 0 \text{ V}$		0.1	1.0	$\mu\text{A}$
$I_{PD}$	CE Pull-down Current			0.2	$\square 0.6$	$\mu\text{A}$
$V_{CEH}$	CE Input Voltage "H"		$\square 2.2$		$\square 42$	V
$V_{CEL}$	CE Input Voltage "L"		0		$\square 1.0$	V

All test items listed under Electrical Characteristics are done under the pulse load condition ( $T_j \approx T_a = 25^\circ\text{C}$ ).

#### VR

( $T_a = 25^\circ\text{C}$ )

Symbol	Item	Conditions	Min.	Typ.	Max.	Unit
$V_{OUT}$	Output Voltage	$V_{SET} + 1 \text{ V} \leq V_{IN} \leq 42 \text{ V}$ ( $V_{SET} < 2.5 \text{ V}$ : $V_{SET} + 1 \text{ V} = 3.5 \text{ V}$ ), $I_{OUT} = 1 \text{ mA}$	$\times 0.994$		$\times 1.006$	V
		$-40^\circ\text{C} \leq T_a \leq 125^\circ\text{C}$	$\square \times 0.984$		$\square \times 1.016$	
$\frac{\Delta V_{OUT}}{\Delta I_{OUT}}$	Load Regulation	$V_{IN} = V_{SET} + 3.0 \text{ V}$ $1 \text{ mA} \leq I_{OUT} \leq 200 \text{ mA}$	$\square -10$	0	$\square 40$	mV
$V_{DIF}$	Dropout Voltage	$I_{OUT} = 200 \text{ mA}$		1.6	$\square 2.5$	V
		$V_{SET} < 2.5 \text{ V}$		1.2	$\square 2.2$	
		$2.5 \text{ V} \leq V_{SET} < 3.3 \text{ V}$		0.8	$\square 2.0$	
		$3.3 \text{ V} \leq V_{SET} < 5.0 \text{ V}$		0.6	$\square 1.2$	
$\frac{\Delta V_{OUT}}{\Delta V_{IN}}$	Line Regulation	$V_{SET} + 1 \text{ V} \leq V_{IN} \leq 42 \text{ V}$ ( $V_{SET} < 2.5 \text{ V}$ : $V_{SET} + 1 \text{ V} = 3.5 \text{ V}$ ), $I_{OUT} = 1 \text{ mA}$	$\square -0.02$	0.01	$\square 0.02$	%/V
$I_{LIM}$	Output Current Limit	$V_{IN} = V_{SET} + 3.0 \text{ V}$	$\square 220$	350	$\square 420$	mA
$I_{SC}$	Short current Limit	$V_{OUT} = 0 \text{ V}$	$\square 60$	80	$\square 110$	mA
$T_{TSD}$	Thermal Shutdown Detection Temperature	Junction Temperature		170		$^\circ\text{C}$
$T_{TSR}$	Thermal Shutdown Release Temperature	Junction Temperature		135		$^\circ\text{C}$

All test items listed under Electrical Characteristics are done under the pulse load condition ( $T_j \approx T_a = 25^\circ\text{C}$ ).

$C_{IN} = C_{OUT} = 0.1 \mu\text{F}$ ,  $V_{IN} = 14 \text{ V}$ , unless otherwise noted.

The specifications surrounded by  $\square$  are guaranteed by design engineering at  $-40^\circ\text{C} \leq T_a \leq 125^\circ\text{C}$ .

**VD**

(Ta = 25°C)

Symbol	Item	Conditions	Min.	Typ.	Max.	Unit	
$-V_{DET}$	Detector Threshold	$V_{DD} = V_{OUT}$ ( $V_{OUT}$ detection)	$T_a = 25^\circ\text{C}$	$\times 0.994$		$\times 1.006$	V
			$-40^\circ\text{C} \leq T_a \leq 125^\circ\text{C}$	$\square \times 0.984$		$\square \times 1.016$	
$V_{HYS}$	Detector Threshold Hysteresis		$\frac{-V_{DET}}{\square \times 0.011}$	$-V_{DET} \times 0.018$	$\frac{-V_{DET}}{\square \times 0.025}$	V	
$t_{delay}$	Release Output Delay Time (Power-on Reset)	$C_D = 10 \text{ nF}$	$\square 3$	6	$\square 15$	ms	
$V_{DOUT}$	$D_{OUT}$ Pull-up Voltage				$\square 5.5$	V	
$I_{OUTDOUT}$	Nch. Output Current ( $D_{OUT}$ Output Pin)	$V_{IN} = 3.5 \text{ V}$ , $V_{DOUT} = 0.1 \text{ V}$	$\square 1.0$	2.6		mA	
$I_{LEAKDOUT}$	Nch. Leakage Current ( $D_{OUT}$ Output Pin)	$V_{DOUT} = 5.5 \text{ V}$			$\square 0.3$	$\mu\text{A}$	
$R_{LCD}$	$C_D$ Pin Discharge Nch Tr.ON Resistance	$V_{CE} = 0 \text{ V}$ , $V_{CD} = 0.1 \text{ V}$		12	$\square 30$	k $\Omega$	
$R_{SENSE}$	SENSE Resistance		$\square 2$		$\square 50$	M $\Omega$	

All test items listed under Electrical Characteristics are done under the pulse load condition ( $T_j \approx T_a = 25^\circ\text{C}$ ).



## Product-specific Electrical Characteristics

## R5112SxxxB-YE

(Ta = 25°C)

Product Name	V <sub>OUT</sub> [V]					V <sub>DET</sub> [V]					V <sub>HYS</sub> [V]	
	Ta = 25°C			-40°C ≤ Ta ≤ 125°C		Ta = 25°C			-40°C ≤ Ta ≤ 125°C			
	Min.	Typ.	Max.	Min.	Max.	Min.	Typ.	Max.	Min.	Max.	Min.	Max.
R5112x011B	4.970	5.000	5.030	4.920	5.080	4.572	4.600	4.628	4.526	4.674	0.050	0.115
R5112x021B	1.789	1.800	1.811	1.771	1.829	1.590	1.600	1.610	1.574	1.626	0.017	0.040
R5112x031B	4.970	5.000	5.030	4.920	5.080	4.473	4.500	4.527	4.428	4.572	0.049	0.113
R5112x041B	4.970	5.000	5.030	4.920	5.080	4.373	4.400	4.427	4.329	4.471	0.048	0.110
R5112x051B	4.970	5.000	5.030	4.920	5.080	4.274	4.300	4.326	4.231	4.369	0.047	0.108
R5112x061B	4.970	5.000	5.030	4.920	5.080	4.174	4.200	4.226	4.132	4.268	0.046	0.105
R5112x071B	4.970	5.000	5.030	4.920	5.080	3.677	3.700	3.723	3.640	3.760	0.040	0.093
R5112x081B	3.280	3.300	3.320	3.247	3.353	2.982	3.000	3.018	2.952	3.048	0.033	0.075
R5112x091B	3.280	3.300	3.320	3.247	3.353	2.882	2.900	2.918	2.853	2.947	0.031	0.073
R5112x101B	3.280	3.300	3.320	3.247	3.353	2.783	2.800	2.817	2.755	2.845	0.030	0.070
R5112x111B	3.280	3.300	3.320	3.247	3.353	2.683	2.700	2.717	2.656	2.744	0.029	0.068
R5112x121B	4.970	5.000	5.030	4.920	5.080	4.075	4.100	4.125	4.034	4.166	0.045	0.103
R5112x131B	3.379	3.400	3.421	3.345	3.455	3.081	3.100	3.119	3.050	3.150	0.034	0.078
R5112x141B	3.280	3.300	3.320	3.247	3.353	3.081	3.100	3.119	3.050	3.150	0.034	0.078
R5112x151B	4.970	5.000	5.030	4.920	5.080	2.982	3.000	3.018	2.952	3.048	0.033	0.075
R5112x161B	2.982	3.000	3.018	2.952	3.048	2.683	2.700	2.717	2.656	2.744	0.029	0.068

## R5112SxxxD-YE

(Ta = 25°C)

Product Name	V <sub>OUT</sub> [V]					V <sub>DET</sub> [V]					V <sub>HYS</sub> [V]	
	Ta = 25°C			-40°C ≤ Ta ≤ 125°C		Ta = 25°C			-40°C ≤ Ta ≤ 125°C			
	Min.	Typ.	Max.	Min.	Max.	Min.	Typ.	Max.	Min.	Max.	Min.	Max.
R5112x011D	4.970	5.000	5.030	4.920	5.080	4.572	4.600	4.628	4.526	4.674	0.050	0.115
R5112x031D	4.970	5.000	5.030	4.920	5.080	4.473	4.500	4.527	4.428	4.572	0.049	0.113
R5112x041D	4.970	5.000	5.030	4.920	5.080	4.373	4.400	4.427	4.329	4.471	0.048	0.110
R5112x051D	4.970	5.000	5.030	4.920	5.080	4.274	4.300	4.326	4.231	4.369	0.047	0.108
R5112x061D	4.970	5.000	5.030	4.920	5.080	4.174	4.200	4.226	4.132	4.268	0.046	0.105
R5112x071D	4.970	5.000	5.030	4.920	5.080	3.677	3.700	3.723	3.640	3.760	0.040	0.093
R5112x081D	3.280	3.300	3.320	3.247	3.353	2.982	3.000	3.018	2.952	3.048	0.033	0.075
R5112x091D	3.280	3.300	3.320	3.247	3.353	2.882	2.900	2.918	2.853	2.947	0.031	0.073
R5112x121D	4.970	5.000	5.030	4.920	5.080	4.075	4.100	4.125	4.034	4.166	0.045	0.103
R5112x131D	3.379	3.400	3.421	3.345	3.455	3.081	3.100	3.119	3.050	3.150	0.034	0.078
R5112x141D	3.280	3.300	3.320	3.247	3.353	3.081	3.100	3.119	3.050	3.150	0.034	0.078
R5112x151D	4.970	5.000	5.030	4.920	5.080	2.982	3.000	3.018	2.952	3.048	0.033	0.075

## THEORY OF OPERATION

### Timing Chart

#### R5112SxxxB/D Voltage Detector

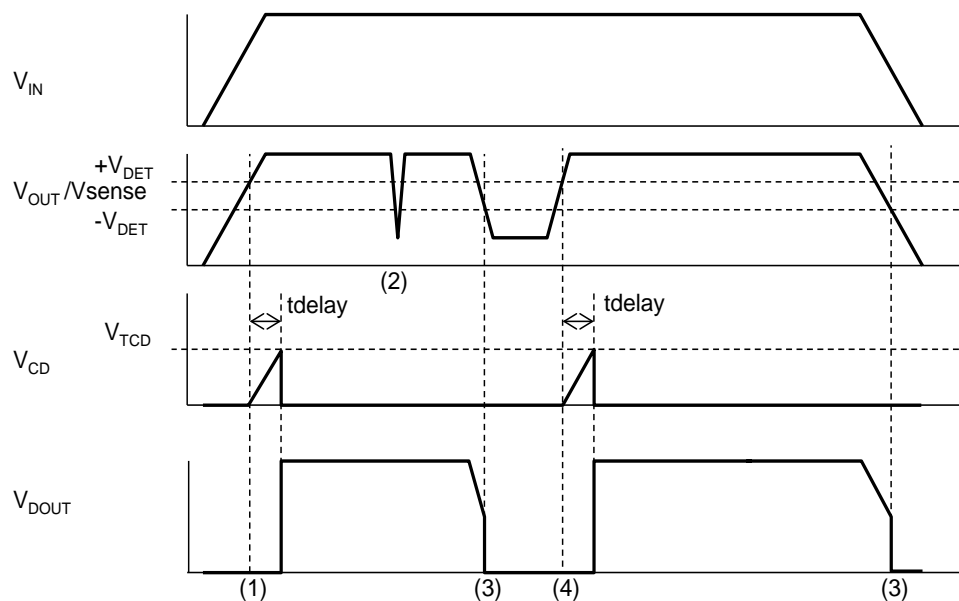

R5112SxxxB/D VD Timing Chart

- (1) When the  $V_{OUT}$  pin voltage ( $V_{OUT}$ )/SENSE pin voltage ( $V_{SENSE}$ ) becomes more than the release voltage ( $+V_{DET}$ ), the  $D_{OUT}$  pin voltage ( $V_{DOUT}$ ) becomes "H" after the release output delay time ( $t_{delay}$ ).
- (2) When the detect output delay time is 25  $\mu\text{s}$  (Typ.) or less even if  $V_{OUT}/V_{SENSE}$  becomes lower than the detector threshold ( $-V_{DET}$ ), the voltage detector (VD) does not go into the detecting state.
- (3) When  $V_{OUT}/V_{SENSE}$  becomes lower than  $-V_{DET}$ ,  $V_{DOUT}$  becomes "L" after the detect output delay time ( $t_{PHL}$ , Typ. 25  $\mu\text{s}$ ) and the VD goes into the detecting state.
- (4) When  $V_{OUT}/V_{SENSE}$  becomes more than  $+V_{DET}$ ,  $V_{DOUT}$  becomes "H" after the release output delay time ( $V_{TCD} = \text{Typ. } 0.73 \text{ V}$ ).

### Delay Operation and Released Output Delay Time ( $t_{\text{delay}}$ )

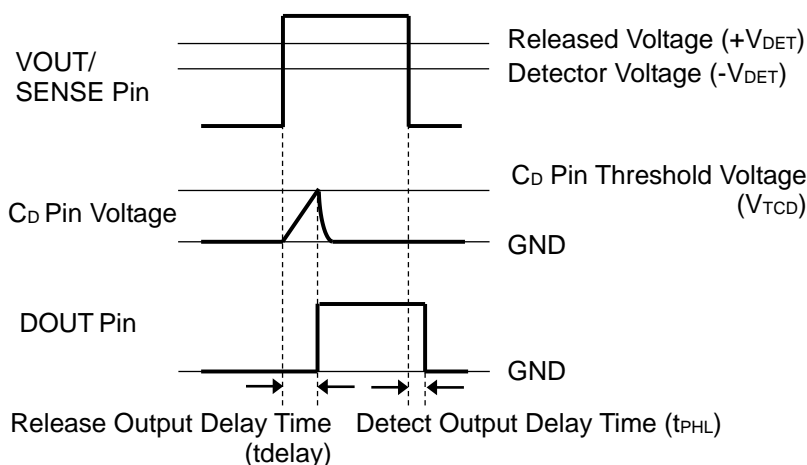

### Released Output Delay Timing Diagram

When the operating voltage higher than the released voltage is applied to VOUT pin (R5112SxxxD) or SENSE pin (R5112SxxxB), charge to an external capacitor starts, then C<sub>D</sub> pin voltage (V<sub>CD</sub>) increases. DOUT pin (R5112SxxxB/D) maintains the released output until V<sub>CD</sub> reaches the threshold voltage of the release output delay pin (V<sub>TCD</sub>). And when V<sub>CD</sub> is over V<sub>TCD</sub>, DOUT pin is inverted from "L" to "H". That is, the charged external capacitor starts discharging.

When the operating voltage lower than the detector threshold is applied to VOUT pin/SENSE pin, the detect output delay time, which is the time until the output voltage is inverted from "H" to "L", remains constant independent of the external capacitor.

### Released Output Delay Time

Released Output Delay Time ( $t_{\text{delay}}$ ) is determined by the following formula. C<sub>D</sub> (F) represents capacitance of the external capacitor

$$t_{\text{delay}} \text{ (s)} = 0.73 \times C_D \text{ (F)} / (1.2 \times 10^{-6})$$

Use 100 pF or higher C<sub>D</sub> when allowing this device to detect VOUT/SENSE pin decreasing slower than 0.1 V/s. Released Output Delay Time indicates the time between the instance when VOUT pin (R5112SxxxD) or SENSE pin (R5112SxxxB) shifts from "1.5 V" to "-V<sub>DET</sub> + 2.0 V" by the application of a pulse voltage and the instance when the output voltage reaches 2.5 V after pulled up DOUT pin (R5112SxxxB/D) to 5.0 V with a resistor of 100 kΩ.

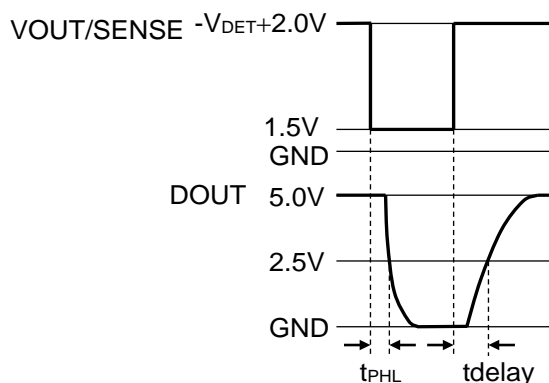

### Voltage Setting (R5112SxxxB/D)

VD detects the drop of the VR output voltage ( $V_{OUT}$ ). When the VD release voltage ( $+V_{DET}$ ) is set to a voltage above the VR output voltage, the reset signal of VD is not released even if VD monitors the VR output voltage returns to the normal value after detecting the drop of VR. To prevent this issue, the following condition is required between  $V_{OUT}$  and  $+V_{DET}$ .

$$(VR \text{ Set Output Voltage}) \times 0.984 - 40 \text{ mV} > (VD \text{ Set Detector Threshold}) \times 1.016 \times 1.025$$

When using a device without the above conditions of  $V_{OUT}$  and  $+V_{DET}$ , careful consideration must be given to the system operation before use.

### Standby Function

When the CE pin voltage ( $V_{CE}$ ) is low, the R5112S goes into the standby mode. During the standby mode, the voltage regulator (VR) stops the output, and the voltage detector (VD) stops the voltage monitoring. When  $V_{CE}$  is low, the DOUT pin voltage ( $V_{DOUT}$ ) is fixed to low regardless of the  $V_{OUT}$  and SENSE pin voltage.

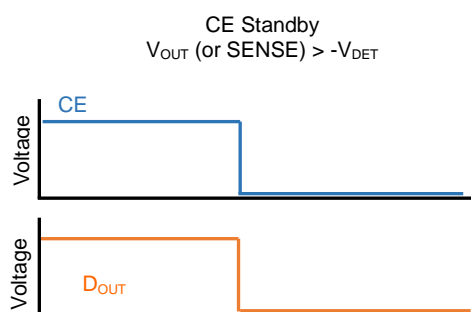

## APPLICATION INFORMATION

### TYPICAL APPLICATIONS

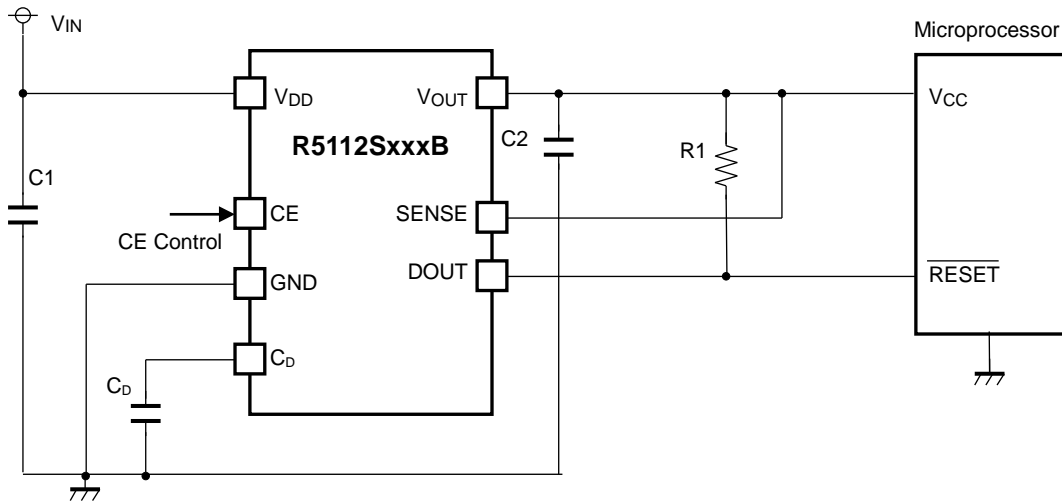

R5112SxxxB Typical Applications

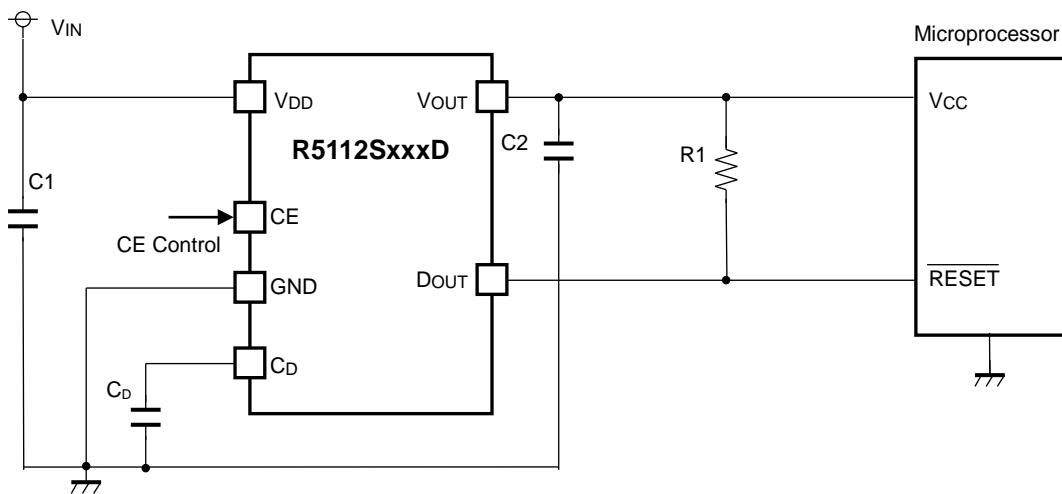

R5112SxxxD Typical Applications

## Recommended Components

Symbol	Description
C1 (C <sub>IN</sub> )	Ceramic Capacitor, 0.1 μF or more, 50V Rated Voltage, CGA3E3X8R1H104K080AB, TDK
C2 (C <sub>OUT</sub> )	Ceramic Capacitor, 0.1 μF or more, 50V Rated Voltage, CGA3E3X8R1H104K080AB, TDK
C <sub>D</sub>	A capacitor corresponding to setting for Release Output Delay Time is required. Refer to <i>Delay Operation and Released Output Delay Time (t<sub>delay</sub>)</i> in <i>THEORY OF OPERATION</i> for details.
R1	A resistor is required to set with consideration of the output current and the leakage current. Refer to <i>ELECTRICAL CHARACTERISTICS</i> for details.

## TYPICAL APPLICATION FOR IC CHIP BREAKDOWN PREVENTION

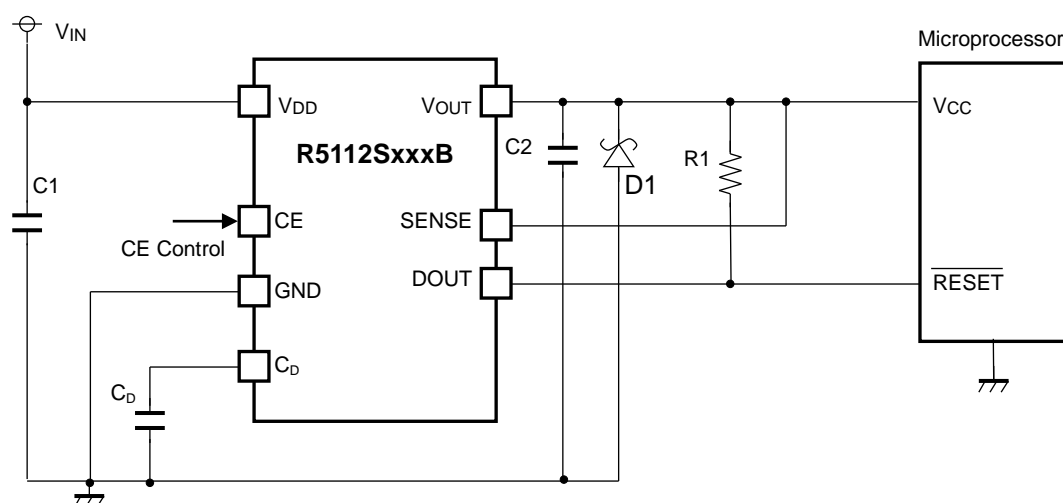

R5112SxxxB Typical Application for IC Chip Breakdown Prevention

When a sudden surge of electrical current travels along the VOUT pin and GND due to a short-circuit, electrical resonance of a circuit involving an output capacitor (C2) and a short circuit inductor generates a negative voltage and may damage the device or the load devices. Connecting a schottky diode (D1) between the VOUT pin and GND has the effect of preventing damage to them.

### Input Transient/Load Transient vs. Output Capacity (C2)

R5112 performs a stable operation by using 0.1  $\mu\text{F}$  of ceramic capacitor as the output capacitor. However, the variation of output voltage may not meet the demand of the system when input voltage and load current vary. In such cases, the variation of output voltage can be minimized significantly by using 10  $\mu\text{F}$  or higher ceramic capacitor. When using a high-capacity electrolytic capacitor for the output line, place the electrolytic capacitor a few centimeters apart from the IC after arranging the ceramic capacitor close to the IC.

Input Transient Response ( $V_{\text{SET}} = 3.3 \text{ V}$ )

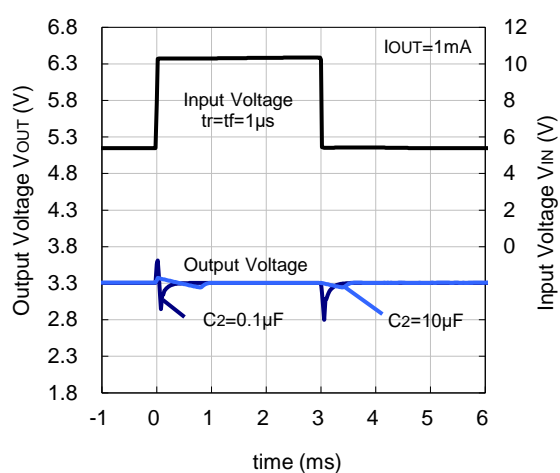

Load Transient Response ( $V_{\text{SET}} = 3.3 \text{ V}$ )

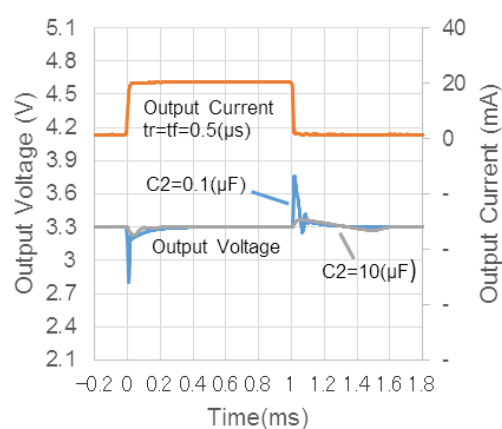

**ESR vs. OUTPUT CURRENT**

It is recommended that a ceramic type capacitor be used for this device. However, other types of capacitors having lower ESR can also be used. The relation between the output current ( $I_{OUT}$ ) and the ESR of output capacitor is shown below.

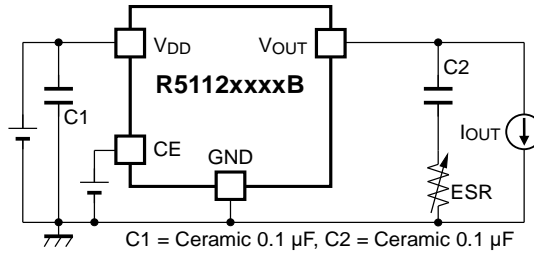

**Measurement Conditions**

Frequency Band: 10 Hz to 2 MHz

Measurement Temperature:  $-40^{\circ}\text{C}$  to  $125^{\circ}\text{C}$

Hatched Area: Noise level is 40  $\mu\text{V}$  (average) or below

Ceramic Capacitors:  $C1 = 0.1 \mu\text{F}$ ,  $C2 = 0.1 \mu\text{F}$

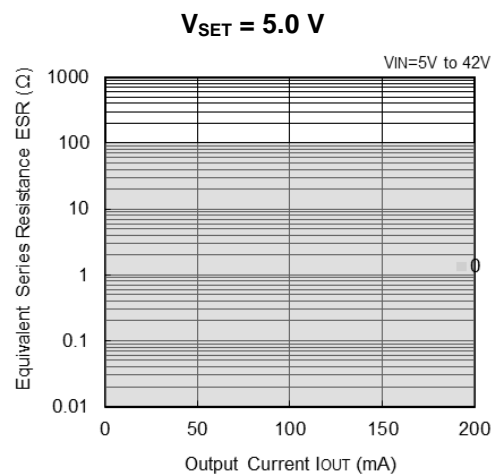
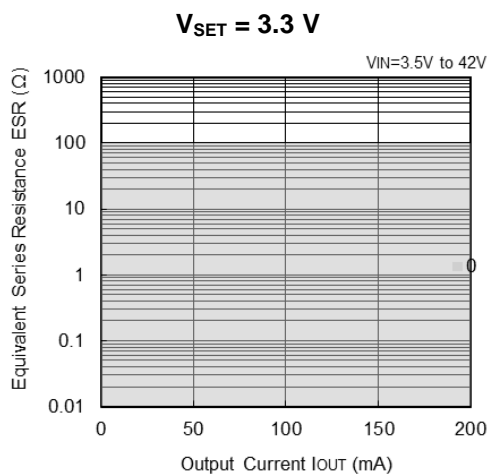
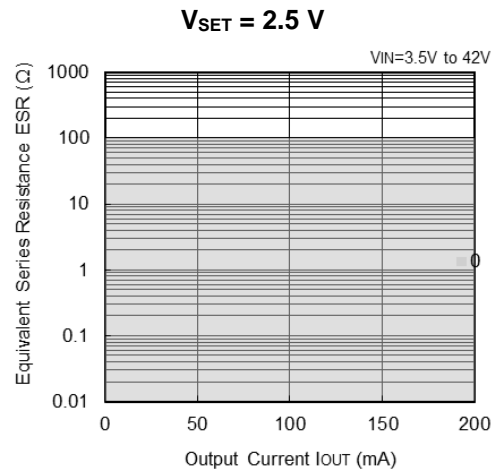
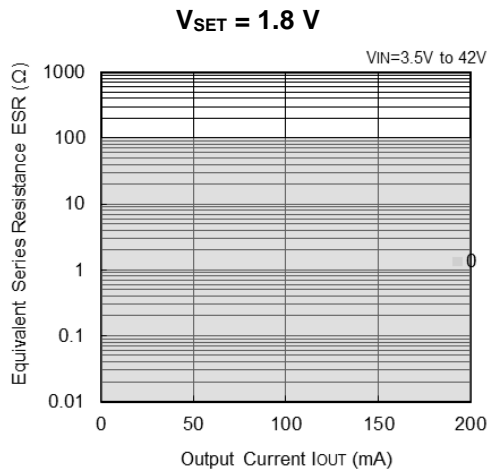



## TECHNICAL NOTES

### Phase Compensation

In the R5112S, phase compensation is provided to secure stable operation even when the load current is varied. For this purpose, be sure to use 0.1  $\mu\text{F}$  or more of a capacitor (C2).

In case of using a tantalum type capacitor and the ESR (Equivalent Series Resistance) value of the capacitor is large, the output might be unstable. Evaluate the circuit including consideration of frequency characteristics.

### PCB Layout

Ensure the VDD and GND lines are sufficiently robust. If their impedance is too high, noise pickup or unstable operation may result. Connect 0.1  $\mu\text{F}$  or more of the capacitor C1 between the VDD and GND, and as close as possible to the pins. In addition, connect the capacitor C2 between VOUT and GND, and as close as possible to the pins.

### Prohibited Area of the Input Voltage Variation

When the input voltage is steeply changed in the following prohibited area, the device may fail to detect or fail to release.

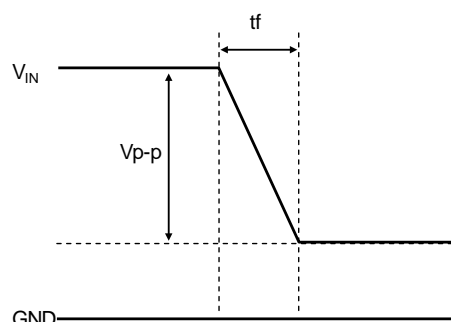
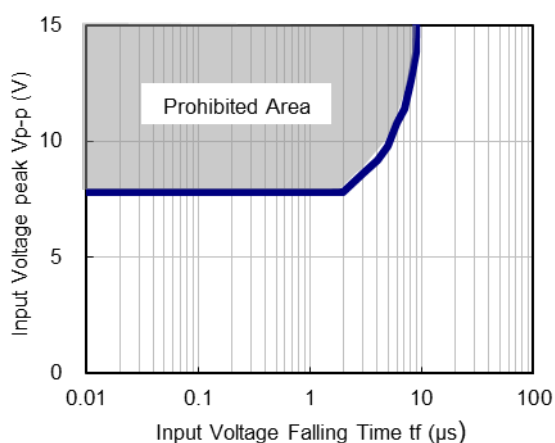

Variation Prohibited Area at Input Voltage ( $V_{IN}$ ) Falling

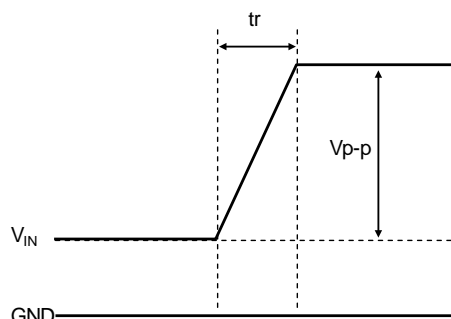
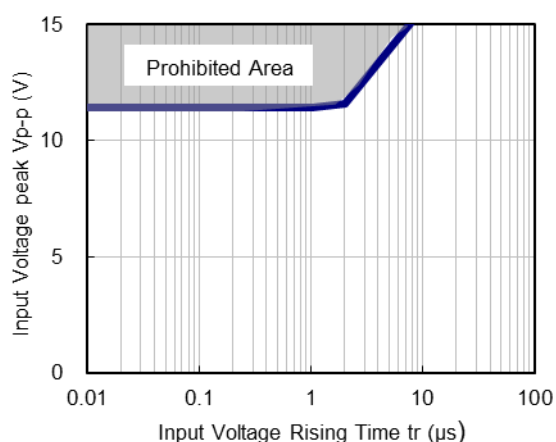

Variation Prohibited Area at Input Voltage ( $V_{IN}$ ) Rising

## TYPICAL CHARACTERISTICS

Note: Typical Characteristics are intended to be used as reference data; they are not guaranteed.

### 1) Output Voltage vs. Output Current (Ta = 25°C)

V<sub>SET</sub> = 1.8 V

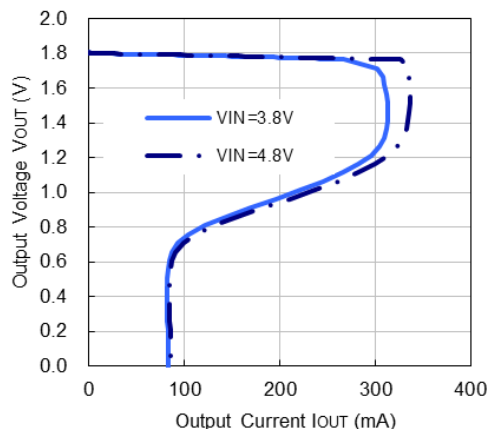

V<sub>SET</sub> = 2.5 V

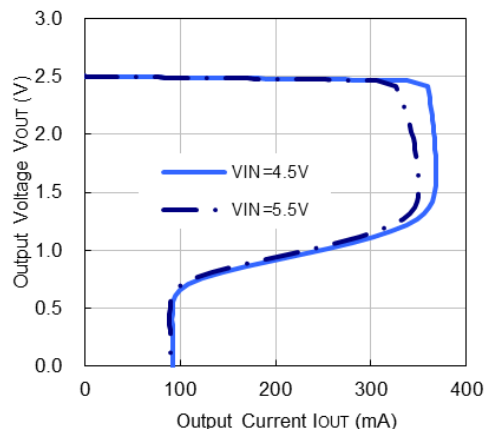

V<sub>SET</sub> = 3.3 V

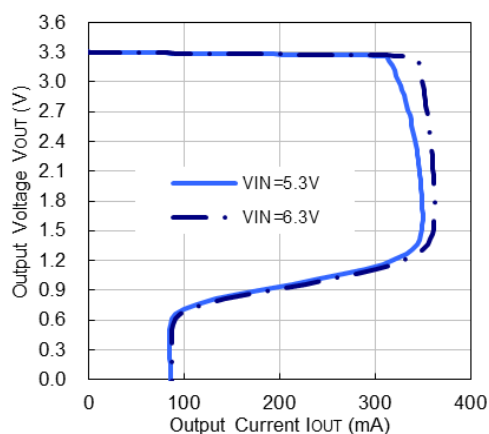

V<sub>SET</sub> = 5.0 V

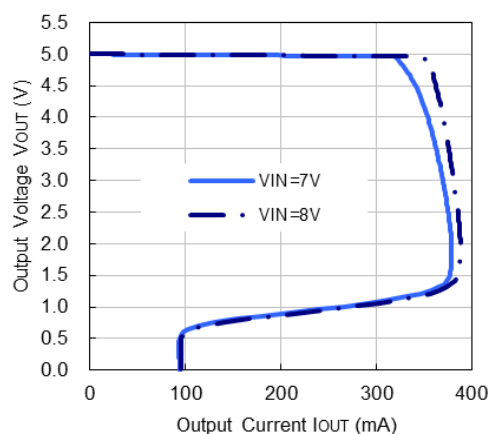

### 2) Output Voltage vs. Input Voltage (Ta = 25°C)

V<sub>SET</sub> = 1.8 V

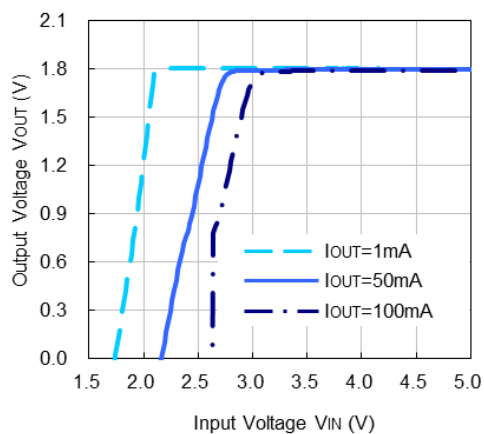

V<sub>SET</sub> = 2.5 V

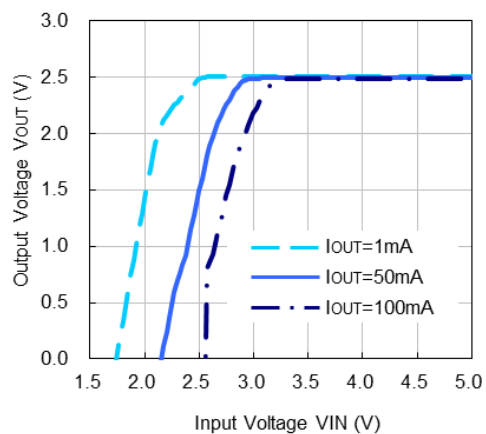

$V_{SET} = 3.3\text{ V}$

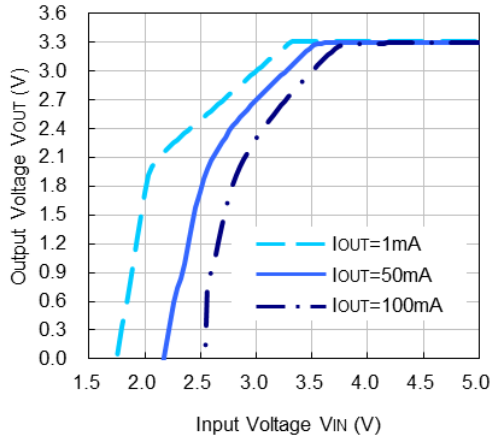

$V_{SET} = 5.0\text{ V}$

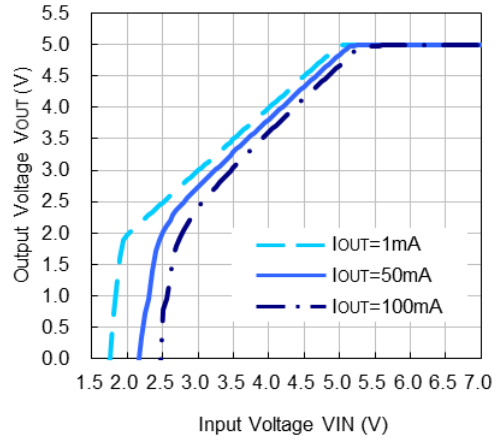

**3) Supply Current vs. Temperature**

$V_{SET} = 1.8\text{ V}$

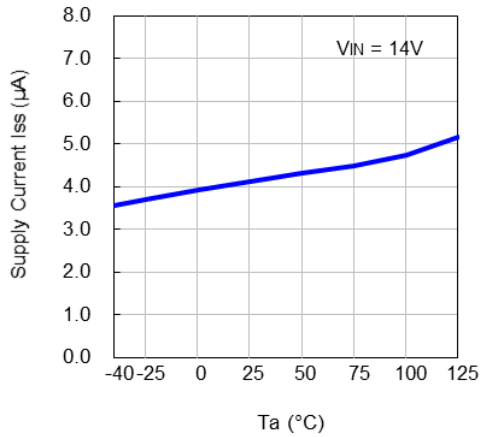

$V_{SET} = 2.5\text{ V}$

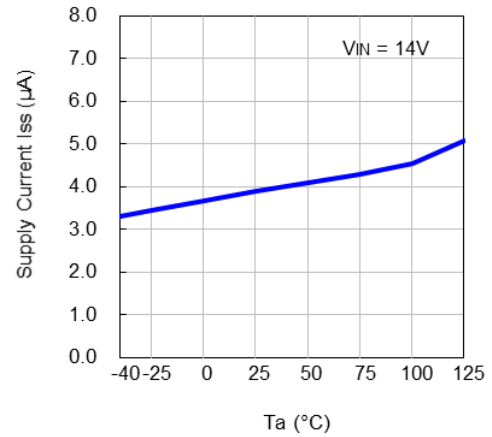

$V_{SET} = 3.3\text{ V}$

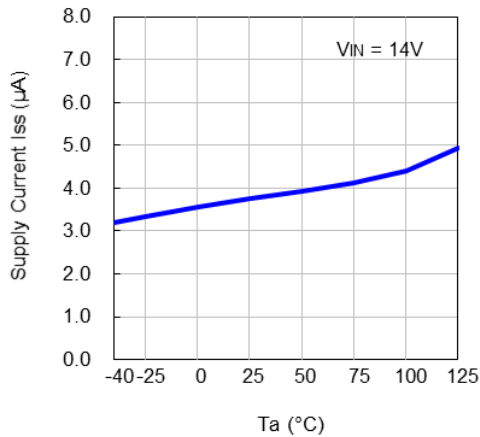

$V_{SET} = 5.0\text{ V}$

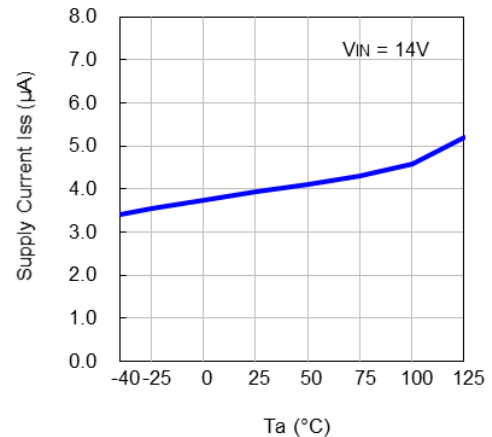

**4) Supply Current vs. Input Voltage**

$V_{SET} = 1.8\text{ V}$

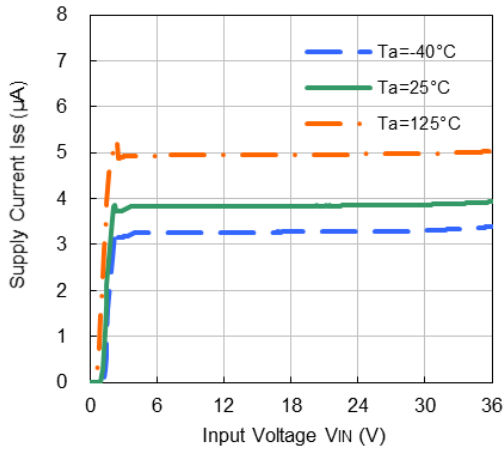

$V_{SET} = 2.5\text{ V}$

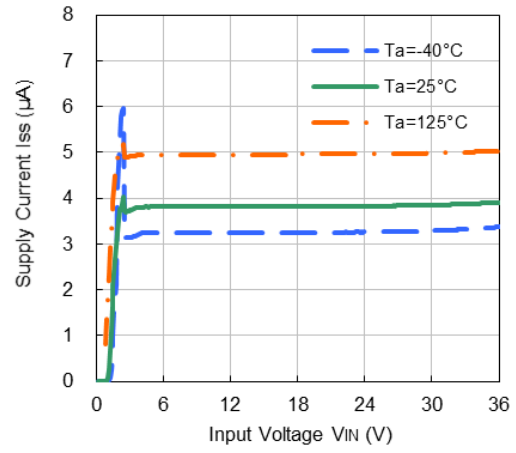

$V_{SET} = 3.3\text{ V}$

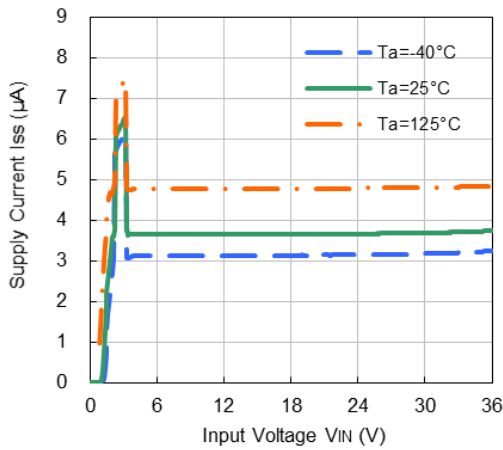

$V_{SET} = 5.0\text{ V}$

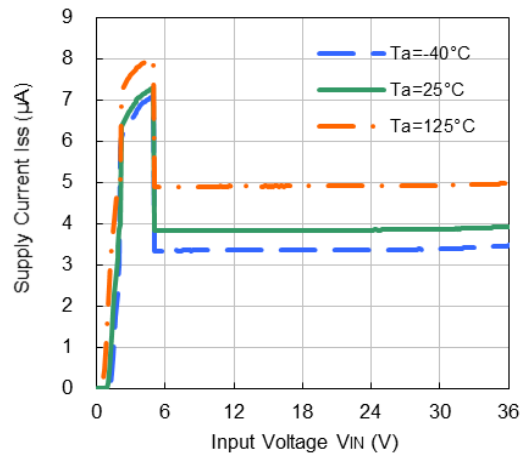

**5) Output Voltage vs. Temperature**

$V_{SET} = 1.8\text{ V}$

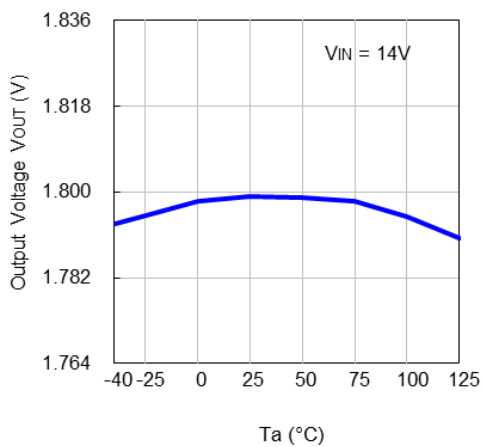

$V_{SET} = 2.5\text{ V}$

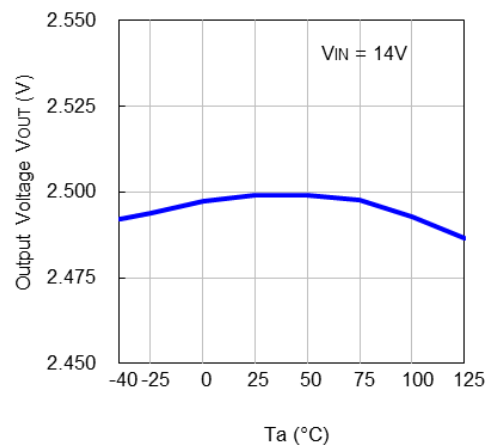

$V_{SET} = 3.3\text{ V}$

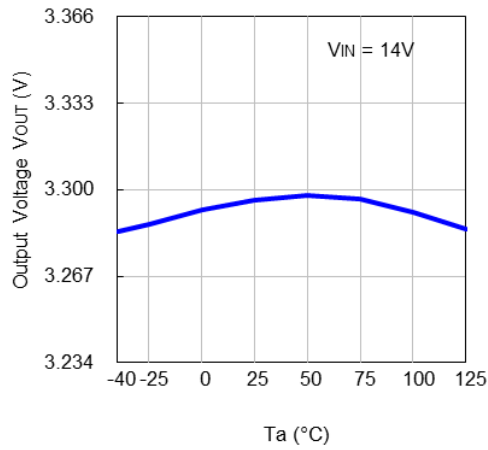

$V_{SET} = 5.0\text{ V}$

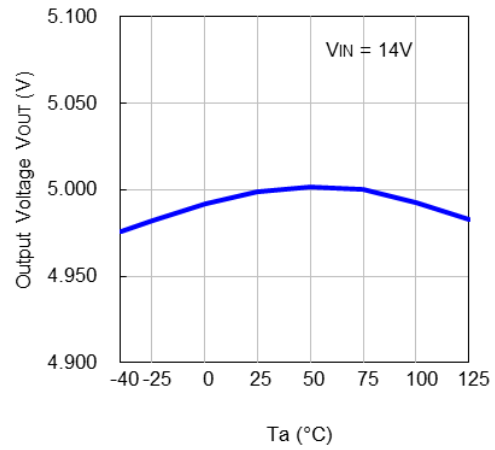

**6) Dropout Voltage vs. Output Current**

$V_{SET} = 1.8\text{ V}$

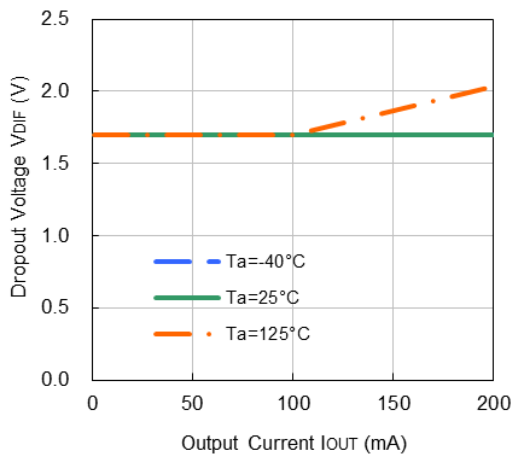

$V_{SET} = 2.5\text{ V}$

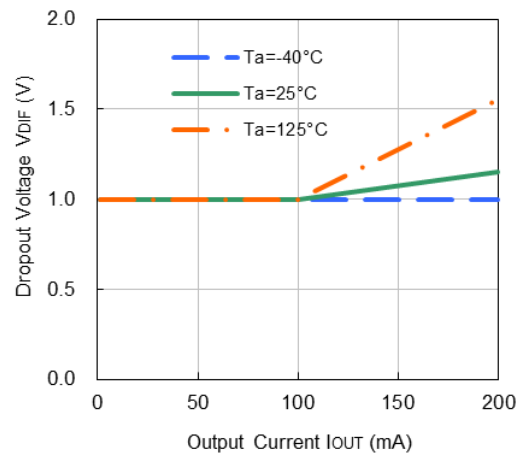

$V_{SET} = 3.3\text{ V}$

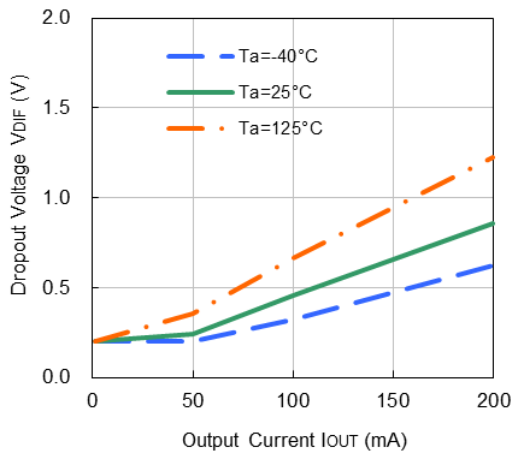

$V_{SET} = 5.0\text{ V}$

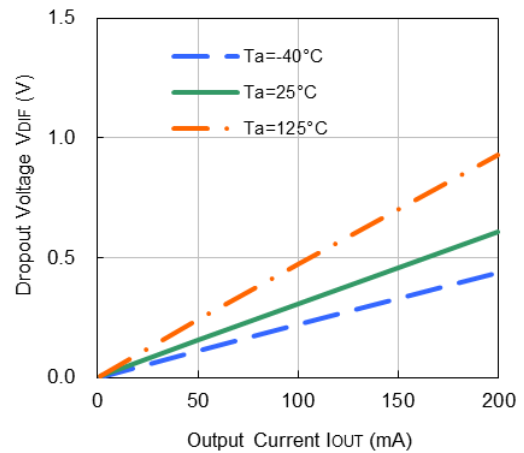

**7) Dropout Voltage vs. Output Voltage (Ta = 25°C)**

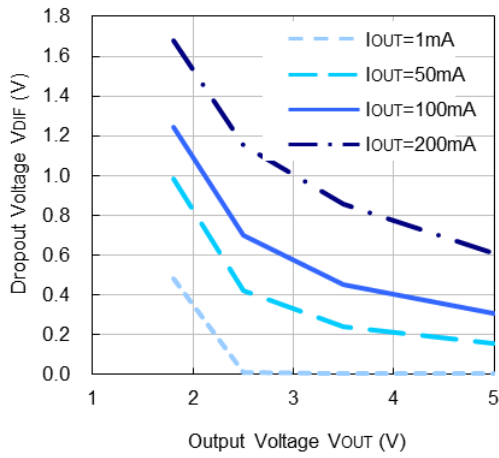

**8) Ripple Rejection vs. Input Voltage (Ta = 25°C, Ripple = 0.2 Vpp)**

V<sub>SET</sub> = 1.8 V

V<sub>SET</sub> = 2.5 V

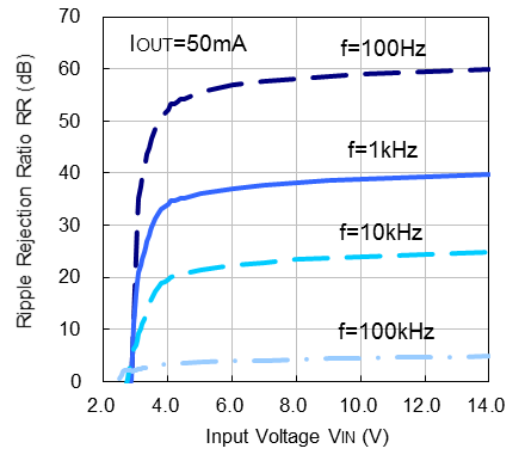
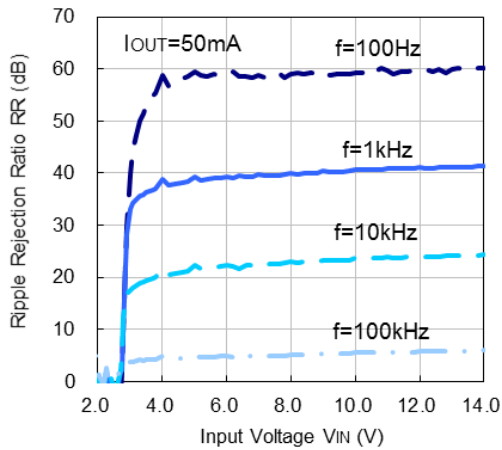

V<sub>SET</sub> = 3.3 V

V<sub>SET</sub> = 5.0 V

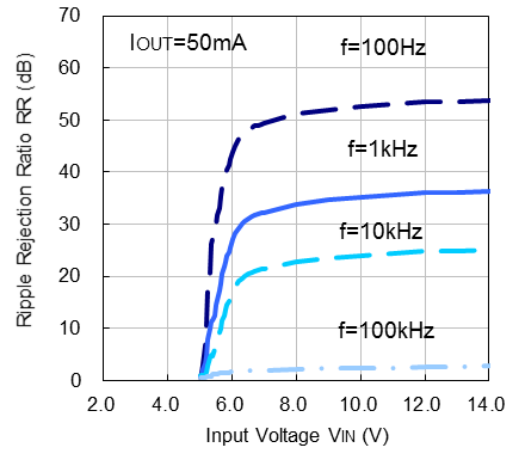
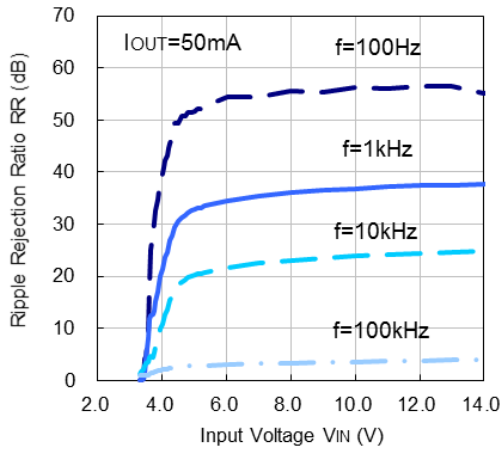

**9) Ripple Rejection vs. Frequency (Ta = 25°C, Ripple = 0.2 Vpp)**

V<sub>SET</sub> = 1.8 V

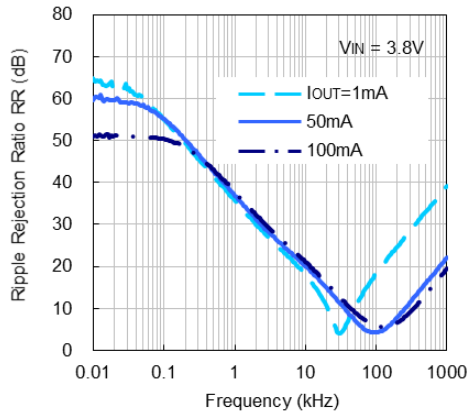

V<sub>SET</sub> = 2.5 V

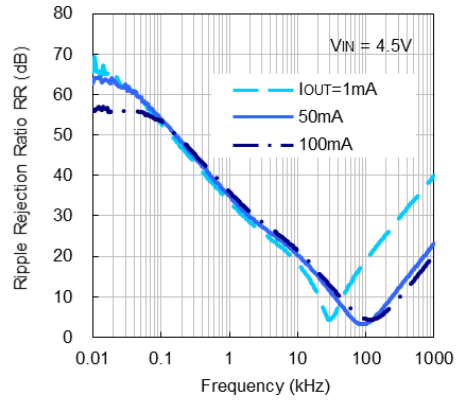

V<sub>SET</sub> = 3.3 V

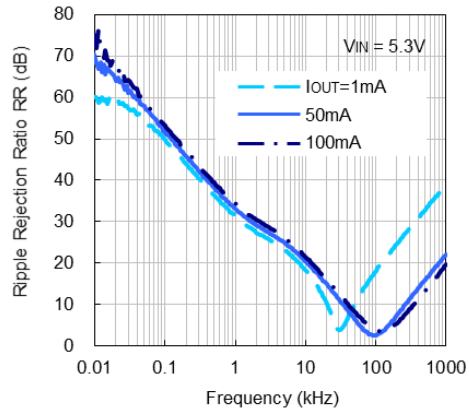

V<sub>SET</sub> = 5.0 V

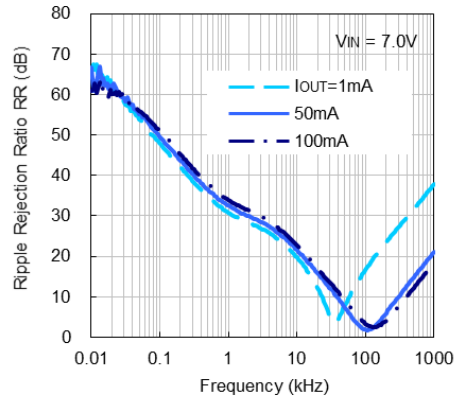

**10) Input Transient Response (Ta = 25°C)**

V<sub>SET</sub> = 1.8 V

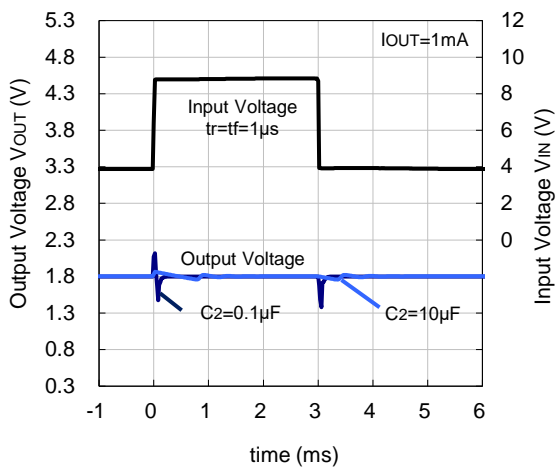

V<sub>SET</sub> = 2.5 V

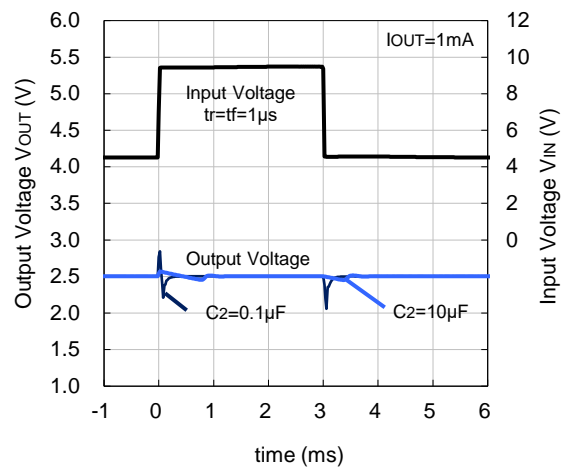

V<sub>SET</sub> = 3.3 V

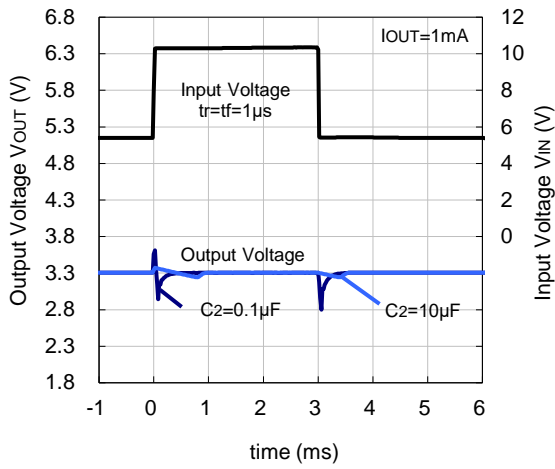

V<sub>SET</sub> = 5.0 V

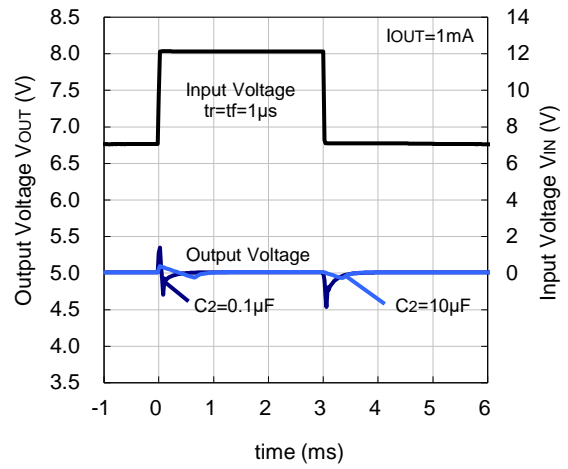

11) Load Transient Response (T<sub>a</sub> = 25°C)

V<sub>SET</sub> = 1.8 V

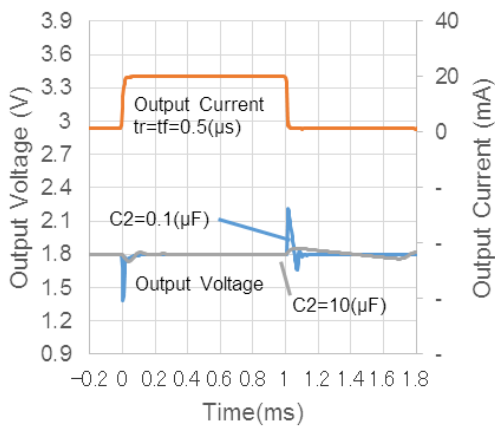

V<sub>SET</sub> = 2.5 V

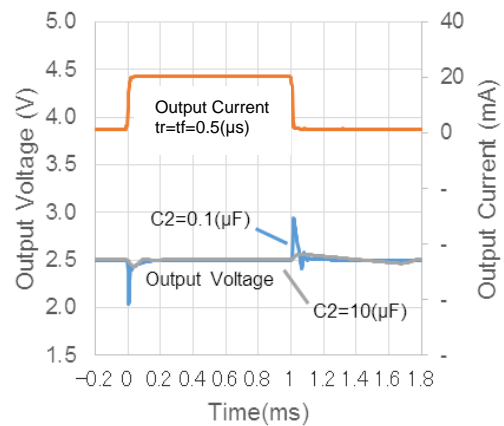

V<sub>SET</sub> = 3.3 V

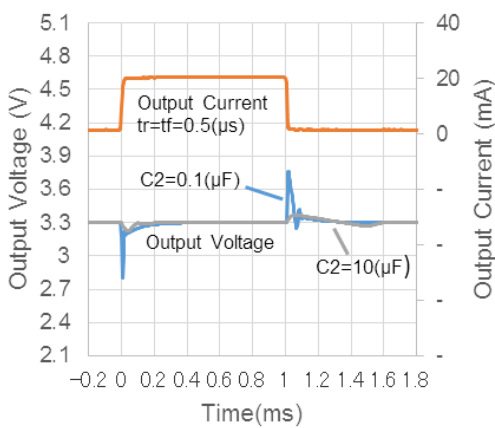

V<sub>SET</sub> = 5.0 V

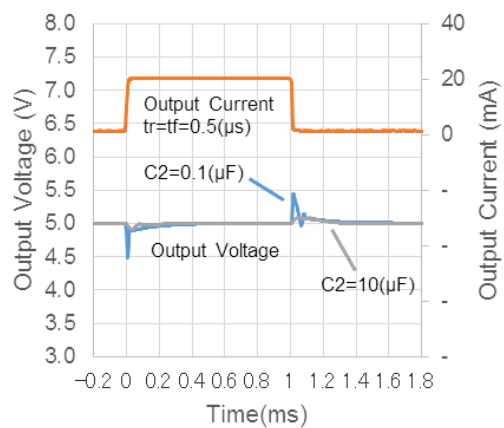



12) CE Transient Response ( $T_a = 25^\circ\text{C}$ )

$V_{\text{SET}} = 1.8\text{ V}$

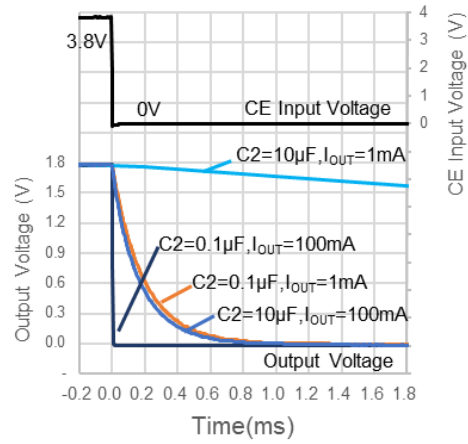
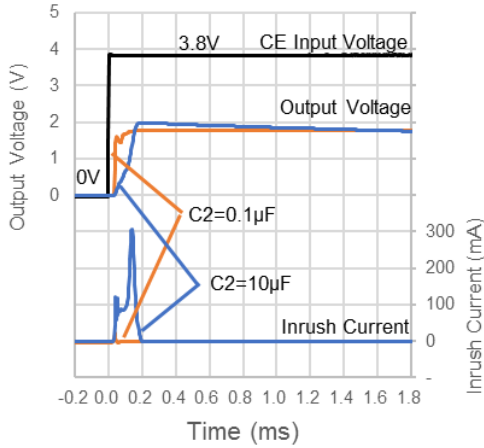

$V_{\text{SET}} = 2.5\text{ V}$

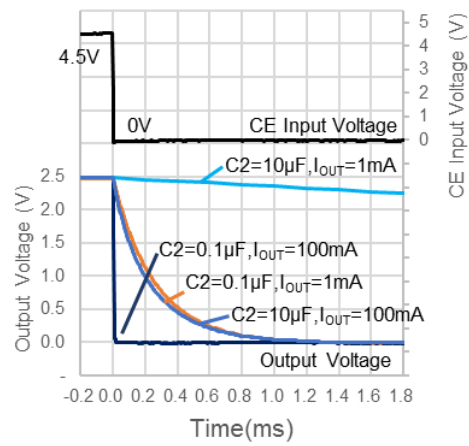
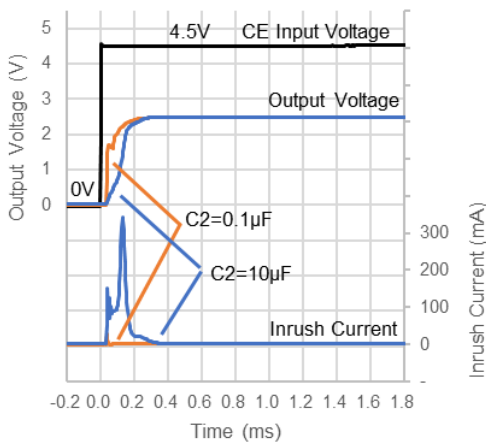

$V_{\text{SET}} = 3.3\text{ V}$

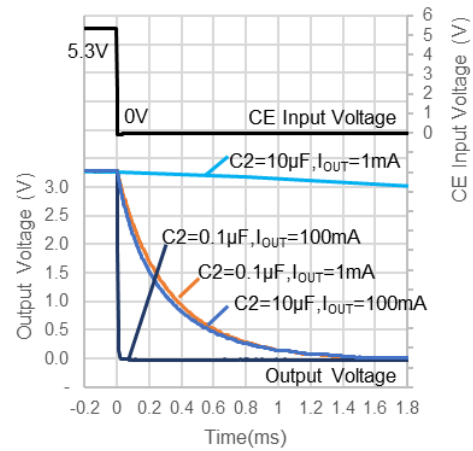
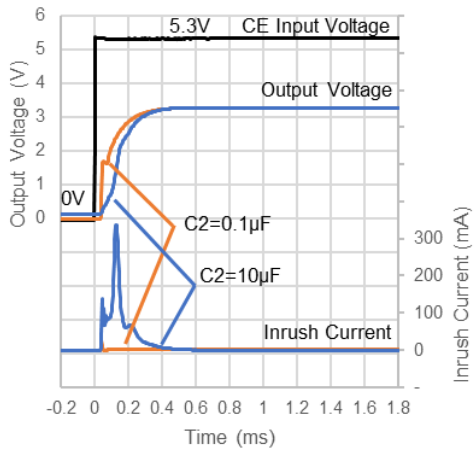

$V_{SET} = 5.0\text{ V}$

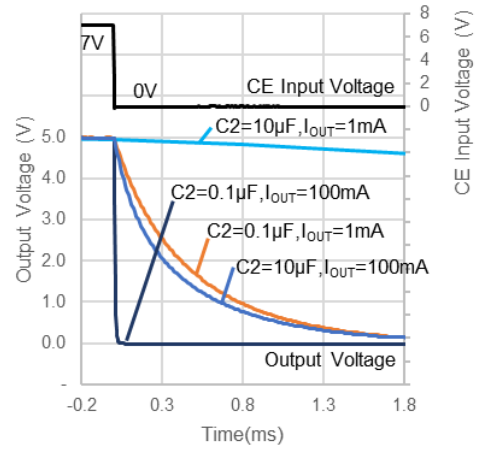
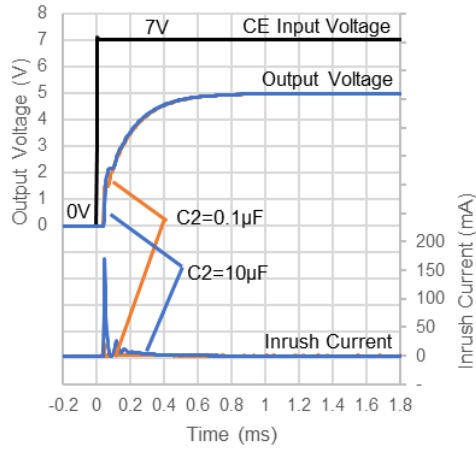

**13) Power-on Transient Response (Ta = 25°C)**

V<sub>SET</sub> = 1.8 V

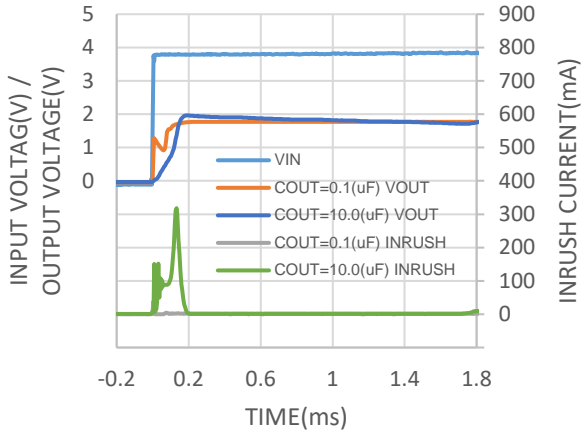

V<sub>SET</sub> = 2.5 V

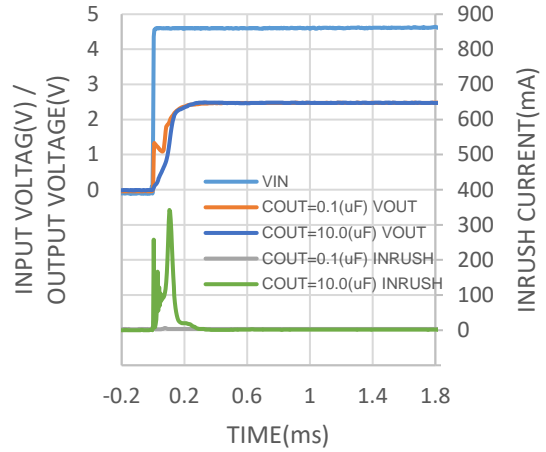

V<sub>SET</sub> = 3.3 V

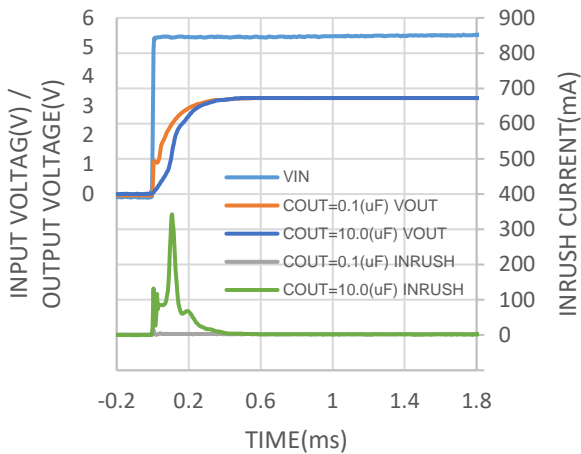

V<sub>SET</sub> = 5.0 V

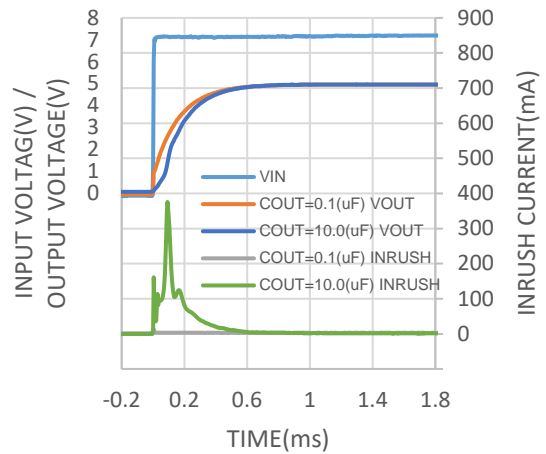

**14) Load Dump (Ta = 25°C)**

V<sub>SET</sub> = 1.8 V

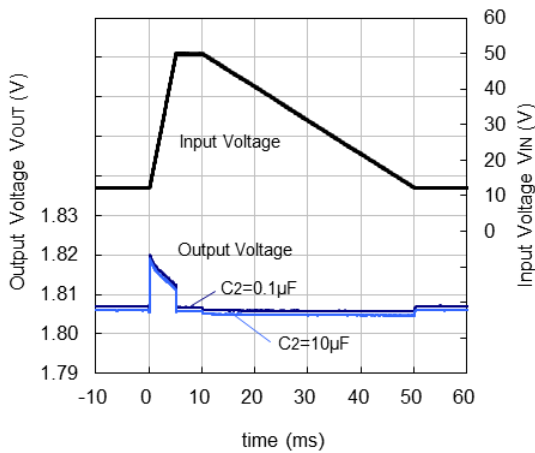

V<sub>SET</sub> = 2.5 V

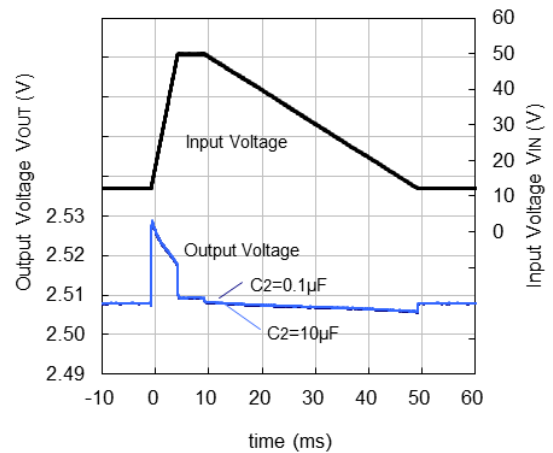

$V_{SET} = 3.3\text{ V}$

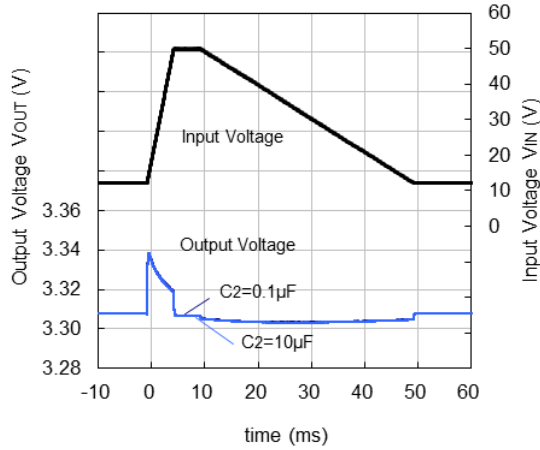

$V_{SET} = 5.0\text{ V}$

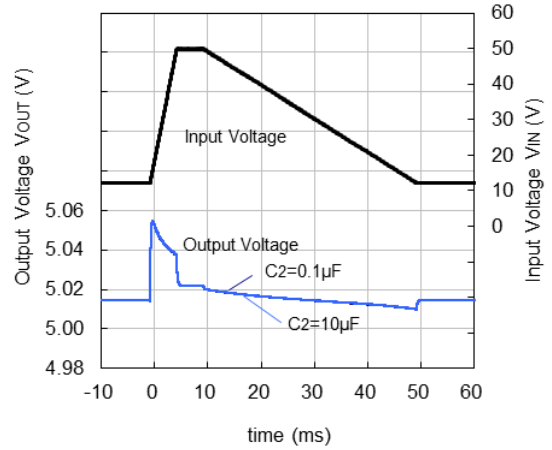

**15) Cranking ( $T_a = 25^\circ\text{C}$ )**

$V_{SET} = 5.0\text{ V}$

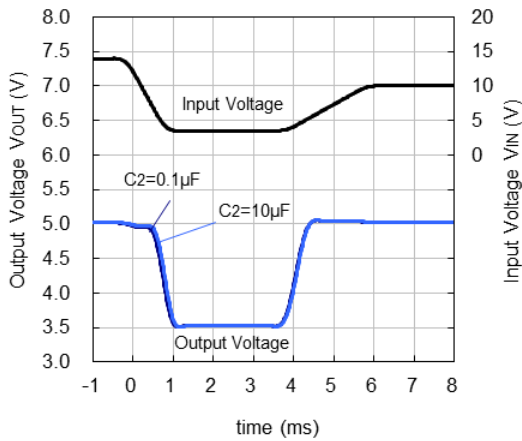

**16) Detect/Release Delay Time vs. Temperature**

Detect Output Delay Time

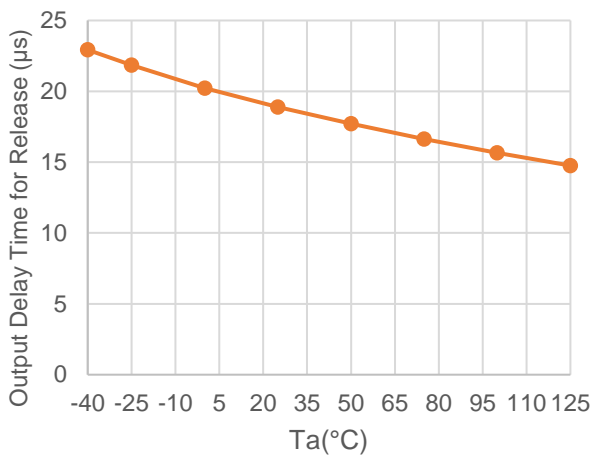

Release Output Delay Time

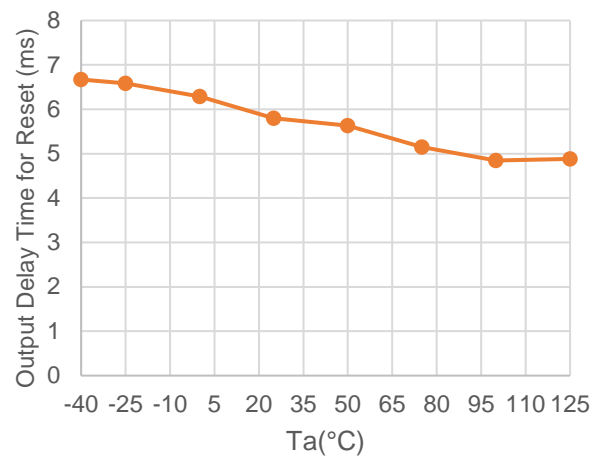

**17) Detect/Release Delay Time vs. Input Voltage**

Detect Output Delay Time

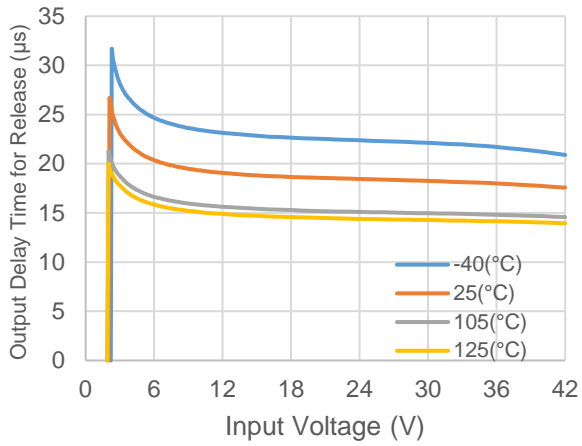

Release Output Delay Time

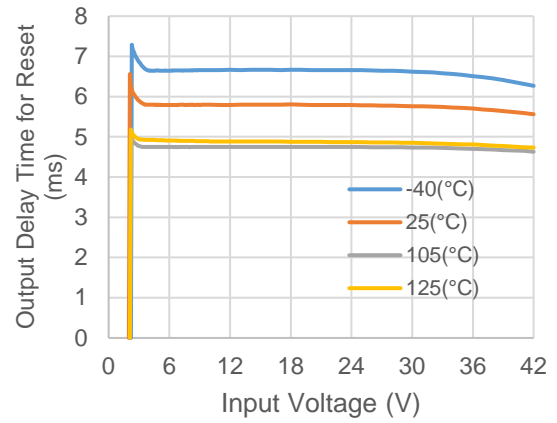

**18) Detect (Release) Delay Time vs. External Capacitance for CD Pin (Ta = 25°C)**

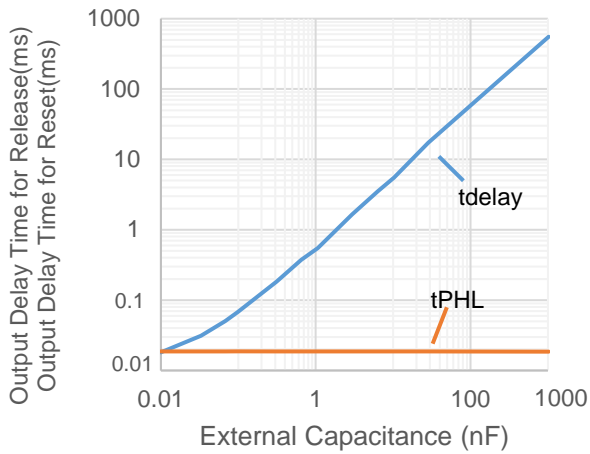

**19) Pulse Width vs. Overdrive Voltage (Ta = 25°C)**

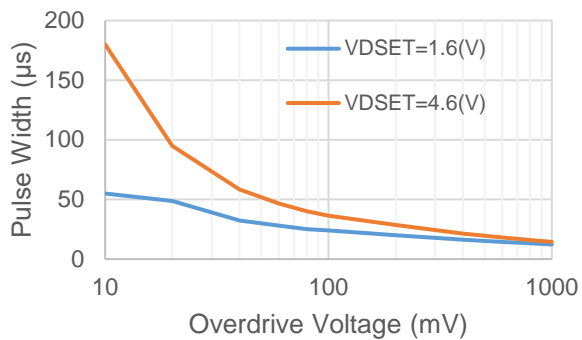

**20) D<sub>OUT</sub> Pin Voltage vs. SENSE Pin Input Voltage (Ta = 25°C)**

-V<sub>SET</sub> = 1.6 V

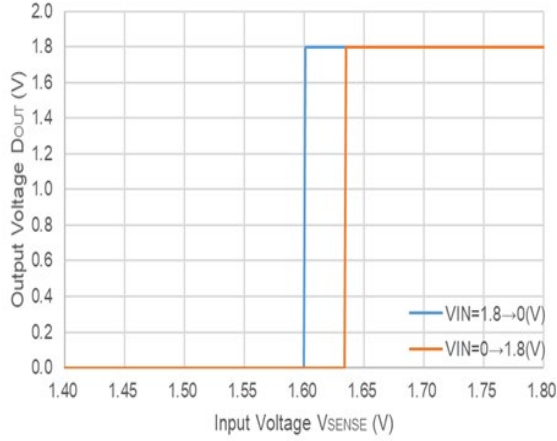

-V<sub>SET</sub> = 2.2 V

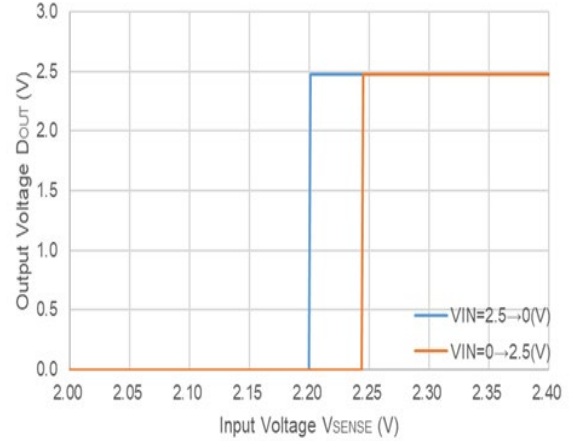

-V<sub>SET</sub> = 3.0 V

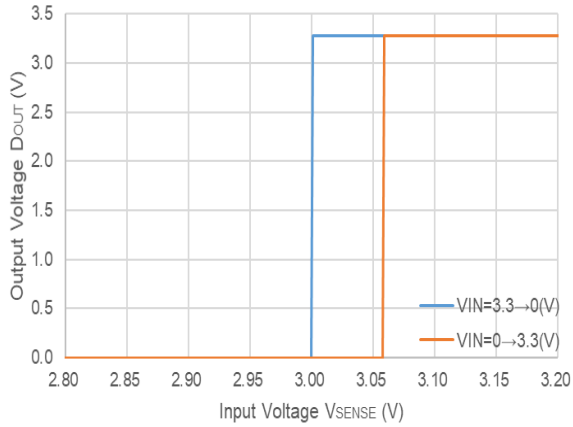

-V<sub>SET</sub> = 4.6 V

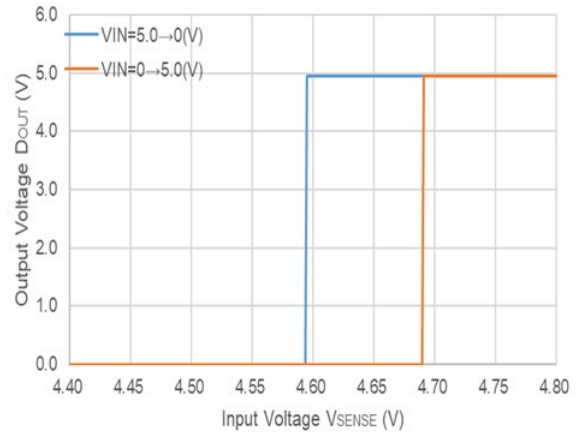

**21) C<sub>D</sub> Driver Output Current vs. Input Voltage**

CE = 5.0 V, SENSE = 5.5 V

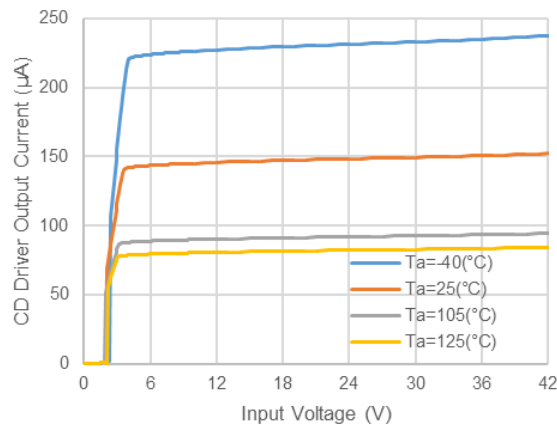

**22) Nch Driver Output Current vs. Input Voltage**

D<sub>OUT</sub> = 0.1 V

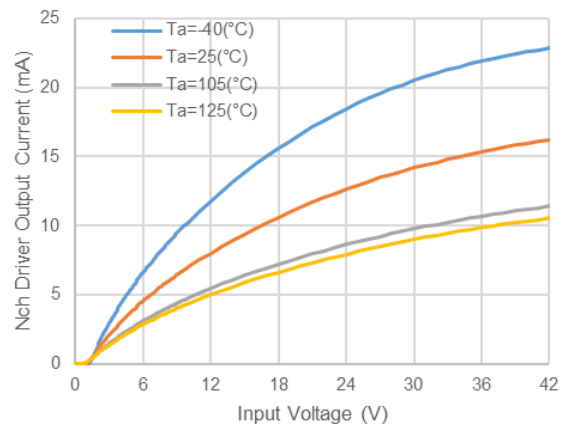

**23) D<sub>OUT</sub> Pin Voltage vs. Input Voltage (V<sub>OUT</sub> Detection) (Ta = 25°C)**

-V<sub>SET</sub> = 1.6 V

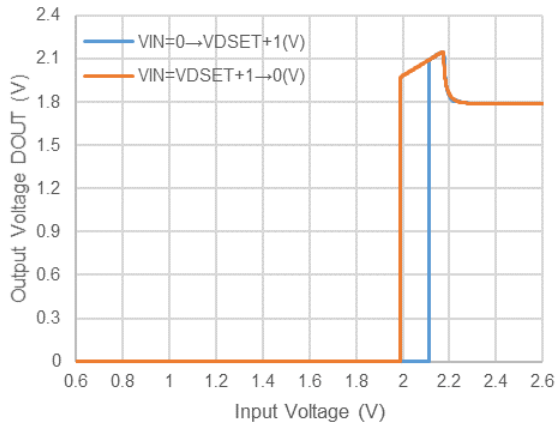

-V<sub>SET</sub> = 2.2 V

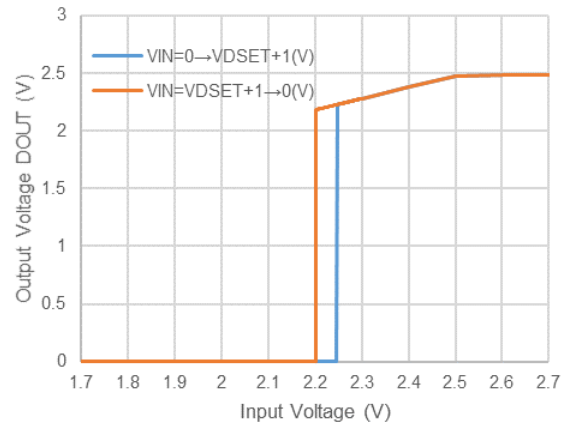

-V<sub>SET</sub> = 3.0 V

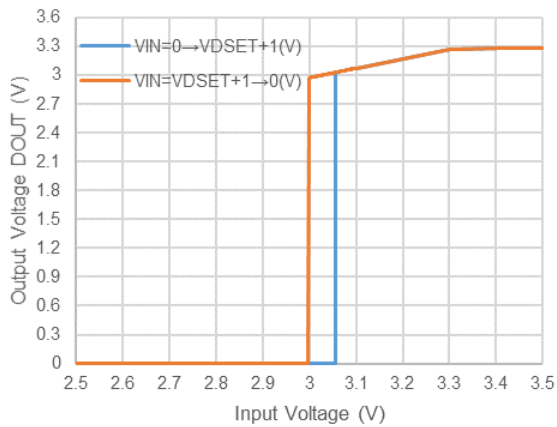

-V<sub>SET</sub> = 4.6 V

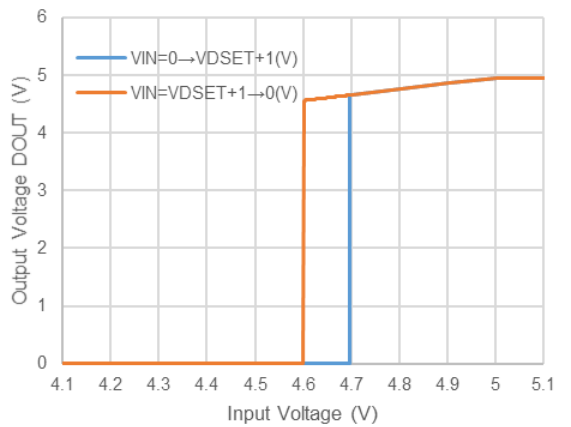

The power dissipation of the package is dependent on PCB material, layout, and environmental conditions. The following measurement conditions are based on JEDEC STD. 51-7.

**Measurement Conditions**

Item	Measurement Conditions
Environment	Mounting on Board (Wind Velocity = 0 m/s)
Board Material	Glass Cloth Epoxy Plastic (Four-Layer Board)
Board Dimensions	76.2 mm × 114.3 mm × 0.8 mm
Copper Ratio	Outer Layer (First Layer): Less than 95% of 50 mm Square Inner Layers (Second and Third Layers): Approx. 100% of 50 mm Square Outer Layer (Fourth Layer): Approx. 100% of 50 mm Square
Through-holes	φ 0.3 mm × 21 pcs

**Measurement Result**

(Ta = 25°C, Tjmax = 150°C)

Item	Measurement Result
Power Dissipation	3600 mW
Thermal Resistance (θja)	θja = 34.5°C/W
Thermal Characterization Parameter (ψjt)	ψjt = 10°C/W

θja: Junction-to-Ambient Thermal Resistance

ψjt: Junction-to-Top Thermal Characterization Parameter

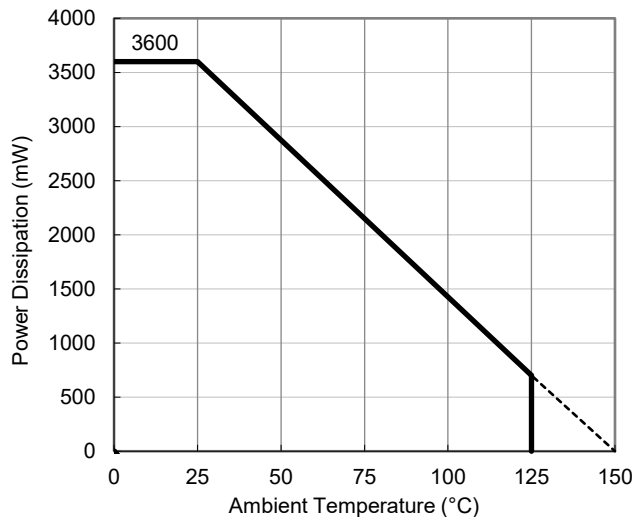

**Power Dissipation vs. Ambient Temperature**

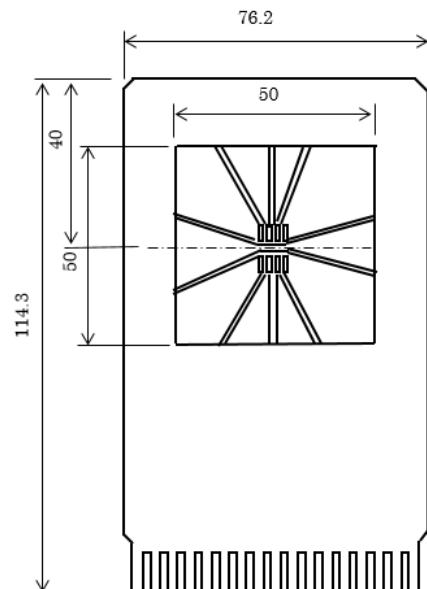

**Measurement Board Pattern**



# PACKAGE DIMENSIONS

# HSOP-8E

DM-HSOP-8E-JE-B

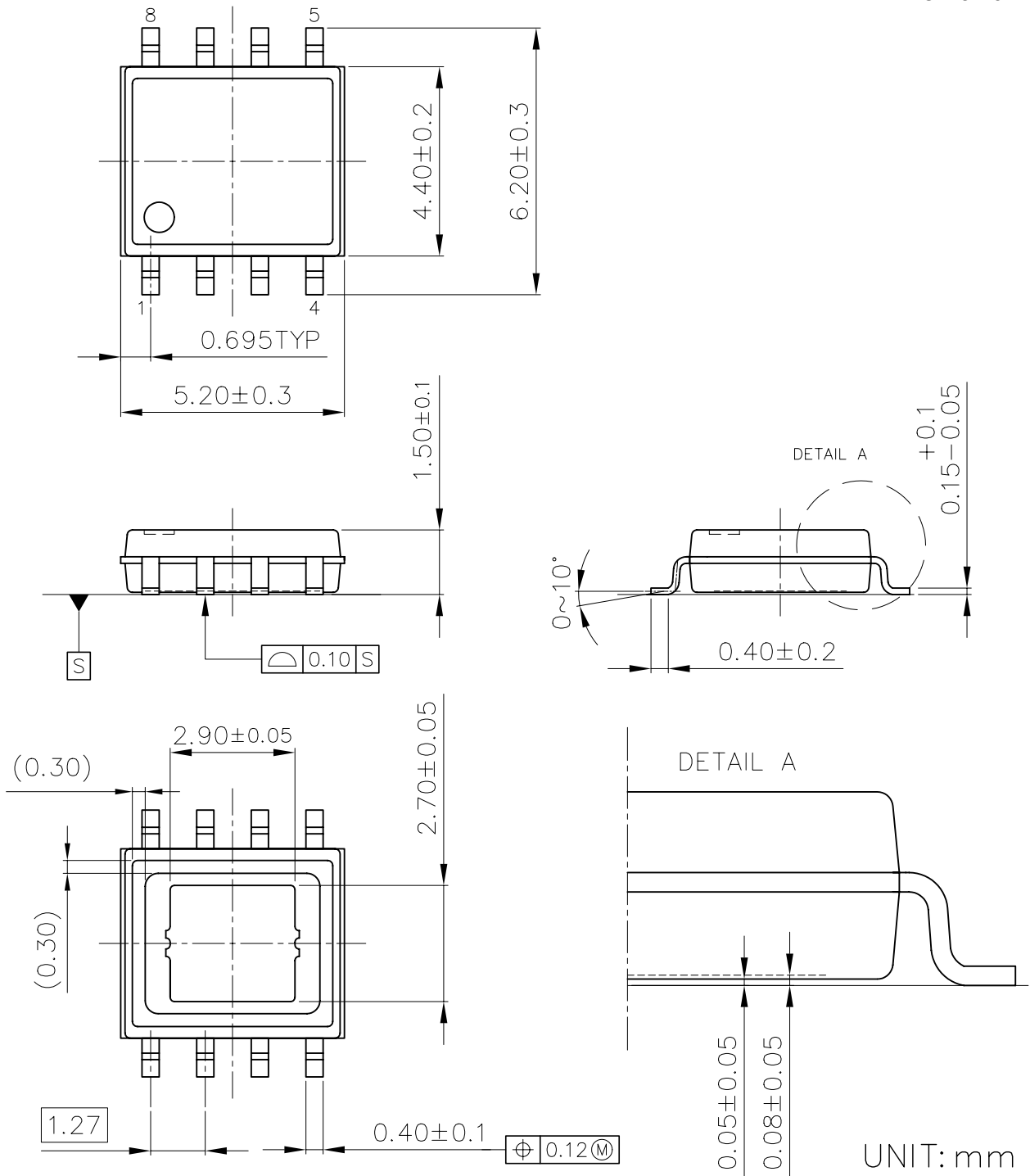

UNIT: mm

HSOP-8E Package Dimensions

# PART MARKINGS

**R5112S**

MK-R5112S-JE-C

①②③④⑤⑥: Product Code ... Refer to *Part Marking List*

⑦⑧⑨: Lot Number ... Alphanumeric Serial Number

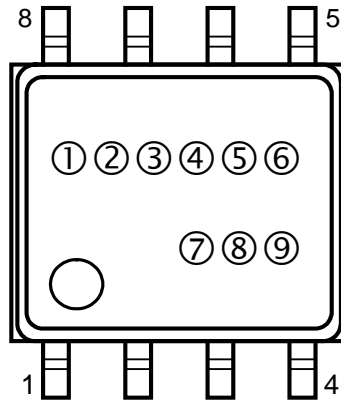

**HSOP-8E Part Markings**

## Part Marking List

### R5112Sxx1B

Product Name	① ② ③ ④ ⑤ ⑥	V <sub>SET</sub>	
		VR	VD
R5112S011B	R S 1 2 0 A	5.0 V	4.6 V
R5112S021B	R S 1 2 0 B	1.8 V	1.6 V
R5112S031B	R S 1 2 0 C	5.0 V	4.5 V
R5112S041B	R S 1 2 0 D	5.0 V	4.4 V
R5112S051B	R S 1 2 0 E	5.0 V	4.3 V
R5112S061B	R S 1 2 0 F	5.0 V	4.2 V
R5112S071B	R S 1 2 0 G	5.0 V	3.7 V
R5112S081B	R S 1 2 0 H	3.3 V	3.0 V
R5112S091B	R S 1 2 0 J	3.3 V	2.9 V
R5112S101B	R S 1 2 0 K	3.3 V	2.8 V
R5112S111B	R S 1 2 0 L	3.3 V	2.7 V
R5112S121B	R S 1 2 0 M	5.0 V	4.1 V
R5112S131B	R S 1 2 0 N	3.4 V	3.1 V
R5112S141B	R S 1 2 0 P	3.3 V	3.1 V
R5112S151B	R S 1 2 0 R	5.0 V	3.0 V
R5112S161B	R S 1 2 0 S	3.0 V	2.7 V

### R5112Sxx1D

Product Name	① ② ③ ④ ⑤ ⑥	V <sub>SET</sub>	
		VR	VD
R5112S011D	R S 1 2 1 A	5.0 V	4.6 V
R5112S031D	R S 1 2 1 C	5.0 V	4.5 V
R5112S041D	R S 1 2 1 D	5.0 V	4.4 V
R5112S051D	R S 1 2 1 E	5.0 V	4.3 V
R5112S061D	R S 1 2 1 F	5.0 V	4.2 V
R5112S071D	R S 1 2 1 G	5.0 V	3.7 V
R5112S081D	R S 1 2 1 H	3.3 V	3.0 V
R5112S091D	R S 1 2 1 J	3.3 V	2.9 V
R5112S121D	R S 1 2 1 M	5.0 V	4.1 V
R5112S131D	R S 1 2 1 N	3.4 V	3.1 V
R5112S141D	R S 1 2 1 P	3.3 V	3.1 V
R5112S151D	R S 1 2 1 R	5.0 V	3.0 V

1. The products and the product specifications described in this document are subject to change or discontinuation of production without notice for reasons such as improvement. Therefore, before deciding to use the products, please refer to our sales representatives for the latest information thereon.
2. The materials in this document may not be copied or otherwise reproduced in whole or in part without the prior written consent of us.
3. This product and any technical information relating thereto are subject to complementary export controls (so-called KNOW controls) under the Foreign Exchange and Foreign Trade Law, and related politics ministerial ordinance of the law. (Note that the complementary export controls are inapplicable to any application-specific products, except rockets and pilotless aircraft, that are insusceptible to design or program changes.) Accordingly, when exporting or carrying abroad this product, follow the Foreign Exchange and Foreign Trade Control Law and its related regulations with respect to the complementary export controls.
4. The technical information described in this document shows typical characteristics and example application circuits for the products. The release of such information is not to be construed as a warranty of or a grant of license under our or any third party's intellectual property rights or any other rights.
5. The products listed in this document are intended and designed for use as general electronic components in standard applications (office equipment, telecommunication equipment, measuring instruments, consumer electronic products, amusement equipment etc.). Those customers intending to use a product in an application requiring extreme quality and reliability, for example, in a highly specific application where the failure or misoperation of the product could result in human injury or death should first contact us.
  - Aerospace Equipment
  - Equipment Used in the Deep Sea
  - Power Generator Control Equipment (nuclear, steam, hydraulic, etc.)
  - Life Maintenance Medical Equipment
  - Fire Alarms / Intruder Detectors
  - Vehicle Control Equipment (automotive, airplane, railroad, ship, etc.)
  - Various Safety Devices
  - Traffic control system
  - Combustion equipment

In case your company desires to use this product for any applications other than general electronic equipment mentioned above, make sure to contact our company in advance. Note that the important requirements mentioned in this section are not applicable to cases where operation requirements such as application conditions are confirmed by our company in writing after consultation with your company.

6. We are making our continuous effort to improve the quality and reliability of our products, but semiconductor products are likely to fail with certain probability. In order to prevent any injury to persons or damages to property resulting from such failure, customers should be careful enough to incorporate safety measures in their design, such as redundancy feature, fire containment feature and fail-safe feature. We do not assume any liability or responsibility for any loss or damage arising from misuse or inappropriate use of the products.
7. The products have been designed and tested to function within controlled environmental conditions. Do not use products under conditions that deviate from methods or applications specified in this datasheet. Failure to employ the products in the proper applications can lead to deterioration, destruction or failure of the products. We shall not be responsible for any bodily injury, fires or accident, property damage or any consequential damages resulting from misuse or misapplication of the products.
8. **Quality Warranty**
  - 8-1. **Quality Warranty Period**

In the case of a product purchased through an authorized distributor or directly from us, the warranty period for this product shall be one (1) year after delivery to your company. For defective products that occurred during this period, we will take the quality warranty measures described in section 8-2. However, if there is an agreement on the warranty period in the basic transaction agreement, quality assurance agreement, delivery specifications, etc., it shall be followed.
  - 8-2. **Quality Warranty Remedies**

When it has been proved defective due to manufacturing factors as a result of defect analysis by us, we will either deliver a substitute for the defective product or refund the purchase price of the defective product.  
Note that such delivery or refund is sole and exclusive remedies to your company for the defective product.
  - 8-3. **Remedies after Quality Warranty Period**

With respect to any defect of this product found after the quality warranty period, the defect will be analyzed by us. On the basis of the defect analysis results, the scope and amounts of damage shall be determined by mutual agreement of both parties. Then we will deal with upper limit in Section 8-2. This provision is not intended to limit any legal rights of your company.
9. Anti-radiation design is not implemented in the products described in this document.
10. The X-ray exposure can influence functions and characteristics of the products. Confirm the product functions and characteristics in the evaluation stage.
11. WLCSP products should be used in light shielded environments. The light exposure can influence functions and characteristics of the products under operation or storage.
12. Warning for handling Gallium and Arsenic (GaAs) products (Applying to GaAs MMIC, Photo Reflector). These products use Gallium (Ga) and Arsenic (As) which are specified as poisonous chemicals by law. For the prevention of a hazard, do not burn, destroy, or process chemically to make them as gas or power. When the product is disposed of, please follow the related regulation and do not mix this with general industrial waste or household waste.
13. Please contact our sales representatives should you have any questions or comments concerning the products or the technical information.



**Nisshinbo Micro Devices Inc.**

**Official website**

<https://www.nisshinbo-microdevices.co.jp/en/>

**Purchase information**

<https://www.nisshinbo-microdevices.co.jp/en/buy/>