



SM10xxxC SERIES



Schottky Barrier Rectifiers



DO-214AB(SMC)

Primary Characteristics

I_F	10	A
V_{RRM}	20~200	V
I_{FSM}	150	A
V_F	0.55, 0.75, 0.85, 0.92	V
T_J max	125, 150	°C

Features

- Low Profile Package
- Ideal for Automated Placement
- Guard Ring for Over Voltage Protection
- Low Forward Voltage Drop

Mechanical Data

- Case : DO-214AB (SMC)
- Case Material : Molded Plastic. UL Flammability Classification Rating 94V-0
- Terminals : Lead free Plating (Tin Finish)
Solderable per MIL-STD-202, Method 208
- Polarity : Cathode Band
- Weight : 0.231 grams (approximate)

Ordering Information

Part No.	Remark	Package	Packing
SM10xxxC	RoHS Compliant	SMC	3000 / Tape & Reel
SM10xxxC-H	Halogen Free		
SM10xxxC-Q	AEC-Q101 qualified		

Maximum Ratings (TA=25°C unless otherwise noted)

Parameter	Symbol	SM102 0C	SM103 0C	SM104 0C	SM105 0C	SM106 0C	SM108 0C	SM101 00C	SM101 50C	SM102 00C	Unit
Maximum Repetitive Peak Reverse Voltage	V_{RRM}	20	30	40	50	60	80	100	150	200	V
Maximum RMS Voltage	V_{RMS}	14	21	28	35	42	56	70	105	140	V
Maximum DC Blocking Voltage	V_{DC}	20	30	40	50	60	80	100	150	200	V
Maximum Average Forward Rectified Current	I_F	10									A
Peak Forward Surge Current 8.3ms Single Half Sine-Wave Superimposed on Rated Load	I_{FSM}	150									A
Maximum Instantaneous Forward Voltage IF=10A @ 25°C	V_F	0.55			0.75		0.85		0.92		V
Maximum DC Reverse Current @ TA=25°C at Rated DC Blocking Voltage @ TA=100°C	I_R	0.5 30					0.2 10				mA
Typical Junction Capacitance (NOTE 1)	C_J	440			355		245		175	140	pF
Typical Thermal Resistance	$R_{\theta JC}$	30									°C/W
Operating Temperature Range	T_J	-55 to +125					-55 to +150				°C
Storage Temperature Range	T_{STG}	-55 to +150									°C
Marking Code		SM102 0C	SM103 0C	SM104 0C	SM105 0C	SM106 0C	SM108 0C	SM101 00C	SM101 50C	SM102 00C	

NOTES :

1. Measured at 1.0MHz and applied reverse voltage of 4.0V DC



Rating and Characteristics Curves

FIG. 1-Typical Forward Current Derating Curve

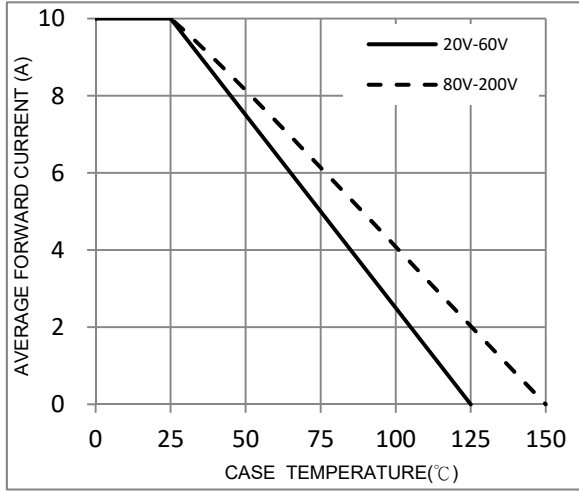

FIG. 2-Typical Forward Characteristics

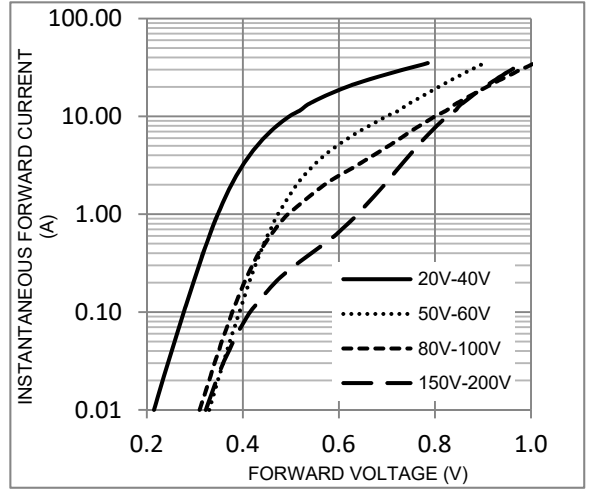

FIG. 3-Maximum Non-Repetitive Forward Surge Current

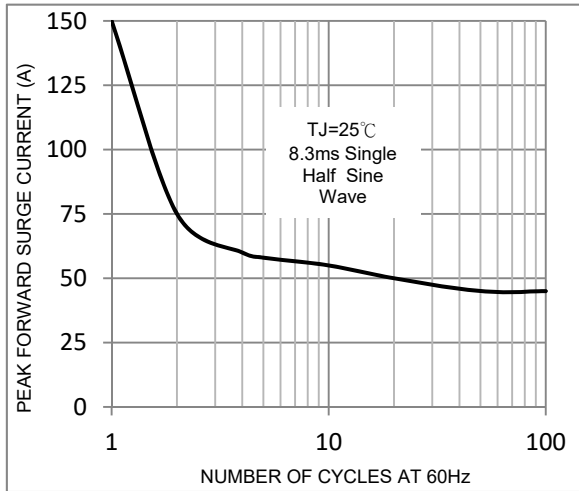

FIG. 4-Typical Reverse Characteristics

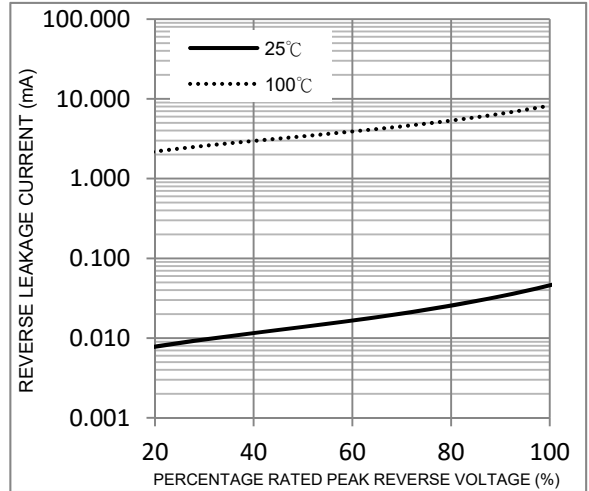
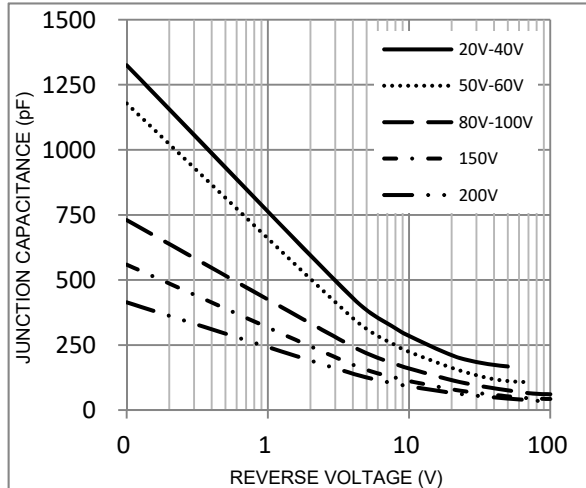
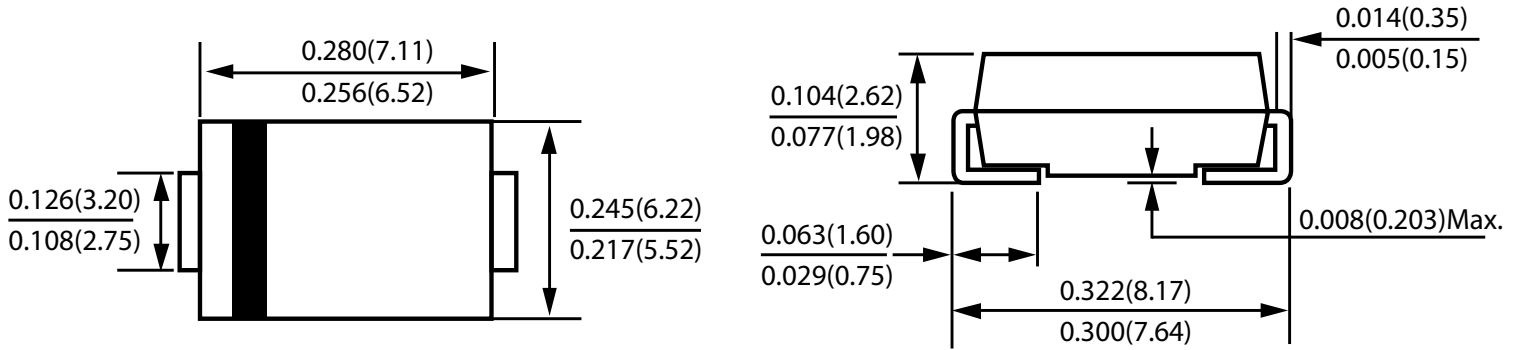

FIG. 5-Typical Junction Capacitance





Package Outline Dimensions



DO-214AB(SMC)

Dimensions in inches and (millimeters)

Marking Information

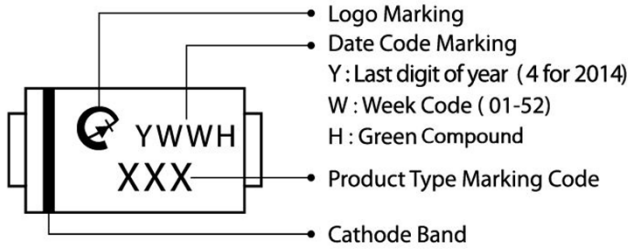

Suggested Pad Layout

Outline Dimension	SMC (DO-214AB)
A	9.40
B	4.40
C	3.30
D	2.50
E	6.80

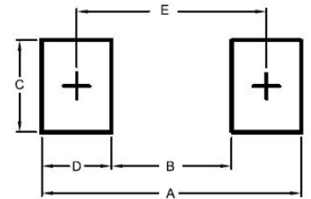

Tape & Reel Specification

Item	Symbol	SMC (mm) DO-214AB
Carrier width	A	6.3 (max)
Carrier length	B	8.6 (max)
Carrier depth	C	2.9 (max)
Sprocket hole	d	1.50 ± 0.1
Reel outside diameter	D	330 ± 2.0
Feed hole diameter	D0	13.5 ± 1.0
Reel inner diameter	D1	50 (min.)
Sprocket hole position	E	1.75 ± 0.1
Punch hole position	F	7.5 ± 0.1
Sprocket hole pitch	P	8.0 ± 0.1
Sprocket hole pitch	P0	4.0 ± 0.1
Embossment center	P1	2.0 ± 0.1
Overall tape thickness	T	0.6 (max)
Tape width	W	16.0 ± 0.3
Reel width	W2	22.4 (max)
Reel width	W1	18.4 (max)

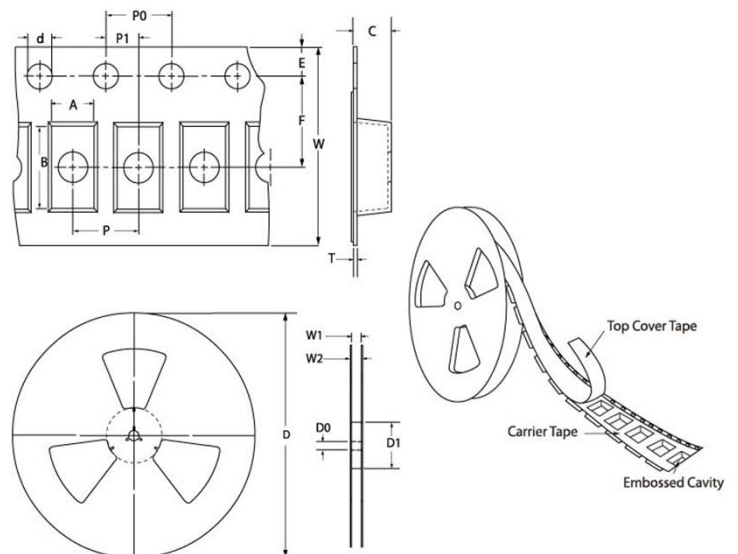



LEGAL DISCLAIMER

- The product is provided “AS IS” without any guarantees or warranty. In association with the product, Eris Technology Corporation, its affiliates, and their directors, officers, employees, agents, successors and assigns (collectively, the “Eris”) makes no warranties of any kind, either express or implied, including but not limited to warranties of merchantability, fitness for a particular purpose, of title, or of non-infringement of third party rights.
- The information in this document and any product described herein are subject to change without notice and should not be construed as a commitment by Eris. Eris assumes no responsibility for any errors that may appear in this document.
- Eris does not assume any liability arising out of the application or use of this document or any product described herein, any Customer or user of this document or products described herein in such applications shall assume all risks of such use and will agree to hold Eris and all the companies whose products are represented on Eris website, harmless against all damages.
- No license, express or implied, by estoppels or otherwise, to any intellectual property is granted by this document or by any conduct of Eris. Product name and markings notes herein may be trademarks of their respective owners.
- Eris does not warrant or accept any liability whatsoever in respect of any products purchased through unauthorized sales channel.
- Should Customers purchase or use Eris products for any unintended or unauthorized application, Customers shall indemnify and hold Eris and its representatives harmless against all claims, damages, expenses, and attorney fees arising out of, directly or indirectly, any claim of personal injury or death associated with such unintended or unauthorized application.
- The official text is written in English and the English version of this document is the only version endorsed by Eris. Any discrepancies or differences created in the translations are not binding and have no legal effect on Eris for compliance or enforcement purposes.