



# SGM8778-1

## High Voltage, 1.2 $\mu$ A Ultra-Low Current, High Precision, Single Differential Comparator

---

### GENERAL DESCRIPTION

The SGM8778-1 series is a single, rail-to-rail input and output, micro-power and high precision voltage comparator optimized for high voltage operation. The device can operate from 1.65V to 40V single supply or from  $\pm 0.85$ V to  $\pm 20$ V dual power supplies. The SGM8778-1 series supports rail-to-rail input while input signal range is from  $(-V_S) - 0.3$ V to  $(+V_S) + 0.3$ V and input common mode voltage range is from  $(-V_S) - 0.1$ V to  $(+V_S) + 0.1$ V. The SGM8778-1 series consumes only 1.2 $\mu$ A low supply current.

The SGM8778-1 series features low input offset voltage of  $\pm 2.2$ mV (MAX). It is suitable for applications requiring precision.

The SGM8778-1 series supports open-drain or push-pull output. The SGM8778A/B/C/D-1 have an open-drain output structure that needs external pull-up resistor. The SGM8778E-1 has a push-pull output structure, which is capable of sinking and sourcing milliamps of current when driving loads.

The SGM8778-1 series is available in a Green SOT-23-5 package. It is rated over the  $-40^{\circ}$ C to  $+125^{\circ}$ C operating temperature range.

### FEATURES

- **Wide Supply Ranges**
  - Single Supply: 1.65V to 40V
  - Dual Supplies:  $\pm 0.85$ V to  $\pm 20$ V
- **Ultra-Low Supply Current: 1.2 $\mu$ A (TYP)**
- **Low Input Offset Voltage:  $\pm 2.2$ mV (MAX) at  $+25^{\circ}$ C**
- **Low Input Bias Current:  $\pm 200$ pA (MAX)**
- **Rail-to-Rail Input and Output**
- **Internal Hysteresis:  $\pm 2.5$ mV (TYP)**
- **Common Mode Rejection Ratio: 105dB (TYP)**
- **Power Supply Rejection Ratio: 105dB (TYP)**
- **Open-Drain Output: SGM8778A/B/C/D-1**
- **Push-Pull Output: SGM8778E-1**
- **Support CMOS or TTL Logic**
- **$-40^{\circ}$ C to  $+125^{\circ}$ C Operating Temperature Range**
- **Available in a Green SOT-23-5 Package**

### APPLICATIONS

Power System Monitor  
Medical Equipment  
Industrial Application  
Battery Management System

# High Voltage, 1.2μA Ultra-Low Current, SGM8778-1 High Precision, Single Differential Comparator

## PACKAGE/ORDERING INFORMATION

MODEL	PACKAGE DESCRIPTION	SPECIFIED TEMPERATURE RANGE	ORDERING NUMBER	PACKAGE MARKING	PACKING OPTION
SGM8778A-1 (Open-Drain)	SOT-23-5	-40°C to +125°C	SGM8778A-1XN5G/TR	0E1XX	Tape and Reel, 3000
SGM8778B-1 (Open-Drain)	SOT-23-5	-40°C to +125°C	SGM8778B-1XN5G/TR	0E2XX	Tape and Reel, 3000
SGM8778C-1 (Open-Drain)	SOT-23-5	-40°C to +125°C	SGM8778C-1XN5G/TR	0E3XX	Tape and Reel, 3000
SGM8778D-1 (Open-Drain)	SOT-23-5	-40°C to +125°C	SGM8778D-1XN5G/TR	0CWXX	Tape and Reel, 3000
SGM8778E-1 (Push-Pull)	SOT-23-5	-40°C to +125°C	SGM8778E-1XN5G/TR	0E4XX	Tape and Reel, 3000

## MARKING INFORMATION

NOTE: XX = Date Code.

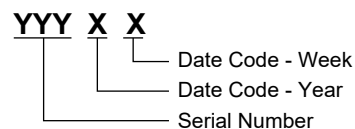

Green (RoHS & HSF): SG Micro Corp defines "Green" to mean Pb-Free (RoHS compatible) and free of halogen substances. If you have additional comments or questions, please contact your SGMICRO representative directly.

## ABSOLUTE MAXIMUM RATINGS

Supply Voltage, +V <sub>S</sub> to -V <sub>S</sub> .....	42V
Differential Input Voltage,  V <sub>ID</sub>   .....	42V
Input/Output Voltage Range..... (-V <sub>S</sub> ) - 0.3V to (+V <sub>S</sub> ) + 0.3V	
Junction Temperature .....	+150°C
Storage Temperature Range.....	-65°C to +150°C
Lead Temperature (Soldering, 10s) .....	+260°C
ESD Susceptibility	
HBM (SGM8778A/B/C/D-1) .....	4000V
HBM (SGM8778E-1).....	8000V
CDM .....	1000V

## RECOMMENDED OPERATING CONDITIONS

Power Supply Range .....	1.65V to 40V
Operating Temperature Range .....	-40°C to +125°C

## OVERSTRESS CAUTION

Stresses beyond those listed in Absolute Maximum Ratings may cause permanent damage to the device. Exposure to absolute maximum rating conditions for extended periods may affect reliability. Functional operation of the device at any

conditions beyond those indicated in the Recommended Operating Conditions section is not implied.

## ESD SENSITIVITY CAUTION

This integrated circuit can be damaged if ESD protections are not considered carefully. SGMICRO recommends that all integrated circuits be handled with appropriate precautions. Failure to observe proper handling and installation procedures can cause damage. ESD damage can range from subtle performance degradation to complete device failure. Precision integrated circuits may be more susceptible to damage because even small parametric changes could cause the device not to meet the published specifications.

## DISCLAIMER

SG Micro Corp reserves the right to make any change in circuit design, or specifications without prior notice.

**PIN CONFIGURATIONS**

**SGM8778A-1 (TOP VIEW)**

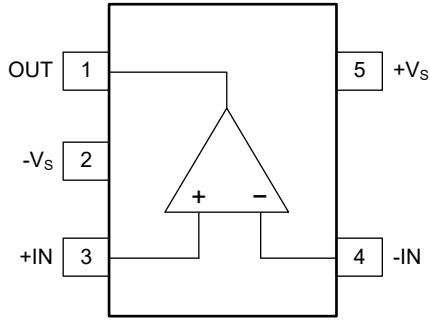

**SOT-23-5**

**SGM8778B-1 (TOP VIEW)**

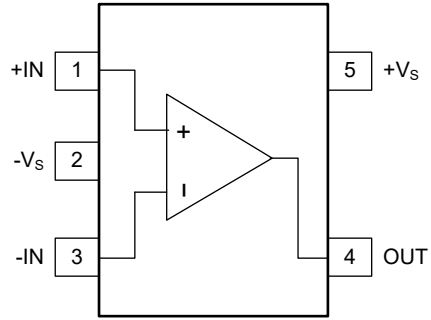

**SOT-23-5**

**SGM8778C-1 (TOP VIEW)**

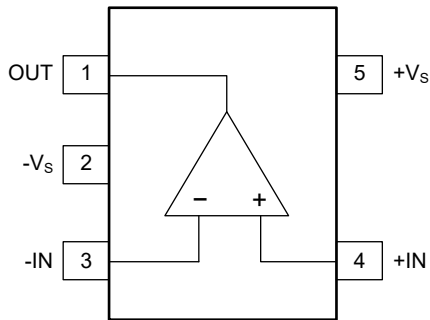

**SOT-23-5**

**SGM8778D-1 (TOP VIEW)**

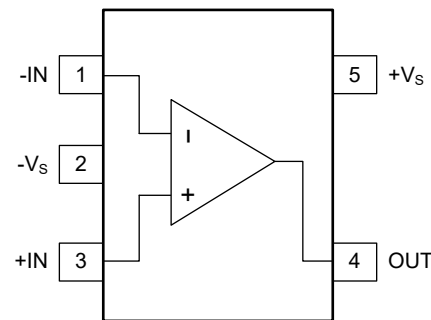

**SOT-23-5**

**SGM8778E-1 (TOP VIEW)**

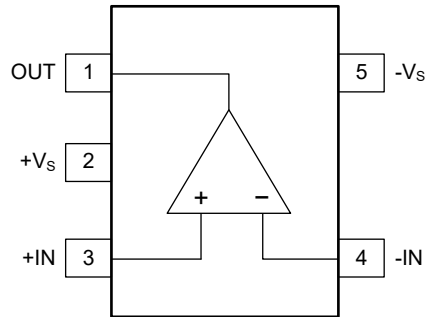

**SOT-23-5**

# SGM8778-1 High Voltage, 1.2µA Ultra-Low Current, High Precision, Single Differential Comparator

## ELECTRICAL CHARACTERISTICS (SGM8778A/B/C/D-1)

( $V_S = 1.65V$  to  $40V$ , Full =  $-40^\circ C$  to  $+125^\circ C$ , typical values are at  $T_A = +25^\circ C$ , unless otherwise noted.)

PARAMETER	SYMBOL	CONDITIONS	TEMP	MIN	TYP	MAX	UNITS
Input Offset Voltage	$V_{OS}$	$V_{CM} = 0V$	+25°C		±0.8	±2.2	mV
			Full			±2.5	
Input Bias Current	$I_B$	$V_{CM} = 0V$	+25°C		±10	±200	pA
			Full			6000	
Input Offset Current	$I_{OS}$	$V_{CM} = 0V$	+25°C		±10	±200	pA
			Full			2000	
Input Common Mode Voltage Range <sup>(1)</sup>	$V_{CM}$		Full	$(-V_S) - 0.1$		$(+V_S) + 0.1$	V
Common Mode Rejection Ratio	CMRR	$V_S = \pm 20V, V_{CM} = (-V_S) \text{ to } (+V_S)$	+25°C	93	105		dB
			Full	90			
Power Supply Rejection Ratio	PSRR		+25°C	93	105		dB
			Full	90			
Low-Level Output Voltage	$V_{OL}$	$V_S = 1.65V, I_{OL} = -8mA, V_{ID} = -0.2V$	+25°C		260	370	mV
			Full			520	
			+25°C		140	180	
			Full			300	
Output Short-Circuit Current	$I_{SINK}$	$V_S = 1.65V, V_{OL} = (-V_S) + 1.5V, V_{ID} = -0.2V$ $V_S = 5V \text{ to } 40V, V_{OL} = (-V_S) + 1.5V, V_{ID} = -0.2V$	+25°C	9	13		mA
			+25°C	51	62		
High-Level Output Current	$I_{OH}$	$V_{OH} - (-V_S) = 2.8V, V_{ID} = 0.2V$ $V_{OH} - (-V_S) = 36V, V_{ID} = 0.2V$	+25°C		40	75	nA
			Full			100	
			+25°C		40	85	
			Full			120	
Supply Current	$I_S$	$I_{OUT} = 0A$	+25°C		1.2	1.4	µA
			Full			2	
Input Hysteresis Voltage	$V_{HYS}$		+25°C	0.8	2.5	3.8	mV
			Full			4.9	

**NOTE:**

1. Any input voltage should not be lower than  $(-V_S) - 0.3V$ . The maximum input common mode voltage is  $(+V_S) + 0.1V$ .

# High Voltage, 1.2µA Ultra-Low Current, SGM8778-1 High Precision, Single Differential Comparator

## ELECTRICAL CHARACTERISTICS (SGM8778E-1)

( $V_S = 1.65V$  to  $40V$ , Full =  $-40^\circ C$  to  $+125^\circ C$ , typical values are at  $T_A = +25^\circ C$ , unless otherwise noted.)

PARAMETER	SYMBOL	CONDITIONS	TEMP	MIN	TYP	MAX	UNITS
Input Offset Voltage	$V_{OS}$	$V_{CM} = 0V$	+25°C		±0.8	±2.2	mV
			Full			±2.5	
Input Bias Current	$I_B$	$V_{CM} = 0V$	+25°C		±10	±200	pA
			Full			6000	
Input Offset Current	$I_{OS}$	$V_{CM} = 0V$	+25°C		±10	±200	pA
			Full			2000	
Input Common Mode Voltage Range <sup>(1)</sup>	$V_{CM}$		Full	$(-V_S) - 0.1$		$(+V_S) + 0.1$	V
Common Mode Rejection Ratio	CMRR	$V_S = \pm 20V, V_{CM} = (-V_S) \text{ to } (+V_S)$	+25°C	93	105		dB
			Full	90			
Power Supply Rejection Ratio	PSRR		+25°C	93	105		dB
			Full	90			
Low-Level Output Voltage	$V_{OL}$	$V_S = 1.65V, I_{OL} = -8mA, V_{ID} = -0.2V$	+25°C		260	370	mV
			Full			520	
		$V_S = 5V \text{ to } 40V, I_{OL} = -8mA, V_{ID} = -0.2V$	+25°C		140	180	
			Full			300	
High-Level Output Voltage	$V_{OH}$	$V_S = 1.65V, I_{OH} = 8mA, V_{ID} = 0.2V$	+25°C		560	850	mV
			Full			1200	
		$V_S = 5V \text{ to } 40V, I_{OH} = 8mA, V_{ID} = 0.2V$	+25°C		420	600	
			Full			900	
Output Short-Circuit Current	$I_{SINK}$	$V_S = 1.65V, V_{OL} = (-V_S) + 1.5V, V_{ID} = -0.2V$ $V_S = 5V \text{ to } 40V, V_{OL} = (-V_S) + 1.5V, V_{ID} = -0.2V$	+25°C	9	13		mA
			+25°C	51	62		
Output Short-Circuit Current <sup>(2)</sup>	$I_{SOURCE}$	$V_S = 1.65V, V_{OL} = (+V_S) - 1.5V, V_{ID} = 0.2V$ $V_S = 5V \text{ to } 40V, V_{OL} = (+V_S) - 1.5V, V_{ID} = 0.2V$	+25°C	9	16		mA
			+25°C	16	24		
Supply Current	$I_S$	$I_{OUT} = 0A$	+25°C		1.2	1.4	µA
			Full			2	
Input Hysteresis Voltage	$V_{HYS}$		+25°C	0.8	2.5	3.8	mV
			Full			4.9	

### NOTES:

- Any input voltage should not be lower than  $(-V_S) - 0.3V$ . The maximum input common mode voltage is  $(+V_S) + 0.1V$ .
- When the output is short-circuited to either  $(-V_S)$  or  $(+V_S)$ , continuous shorting at high supply voltages may cause significant overheating. This can elevate the junction temperature beyond its maximum limit, potentially resulting in irreversible damage to the device.

# High Voltage, 1.2µA Ultra-Low Current, SGM8778-1 High Precision, Single Differential Comparator

## SWITCHING CHARACTERISTICS (SGM8778A/B/C/D-1)

(V<sub>S</sub> = 5V, V<sub>CM</sub> = 0V or (+V<sub>S</sub>), C<sub>L</sub> = 15pF, Full = -40°C to +125°C, typical values are at T<sub>A</sub> = +25°C, unless otherwise noted.)

PARAMETER	SYMBOL	CONDITIONS	TEMP	MIN	TYP	MAX <sup>(1)</sup>	UNITS
Propagation Delay	t <sub>PLH</sub>	V <sub>OD</sub> = 20mV, R <sub>PULL</sub> = 4.7kΩ	+25°C		3.5	5.5	µs
			Full			6.5	
		V <sub>OD</sub> = 100mV, R <sub>PULL</sub> = 4.7kΩ	+25°C		2.5	4	
			Full			5	
	t <sub>PHL</sub>	V <sub>OD</sub> = 20mV	+25°C		3	4.5	
			Full			5	
		V <sub>OD</sub> = 100mV	+25°C		2	3	
			Full			3.5	
Propagation Delay Mismatch	t <sub>SKEW</sub>	V <sub>OD</sub> = 20mV or 100mV, R <sub>PULL</sub> = 4.7kΩ	Full		650	1500	ns
Maximum Toggle Frequency	f <sub>MAX</sub>	V <sub>CM</sub> = 0V, R <sub>PULL</sub> = 4.7kΩ	+25°C		250		kHz

NOTE:

- Specified by design and characterization, not production tested.

## SWITCHING CHARACTERISTICS (SGM8778E-1)

(V<sub>S</sub> = 5V, V<sub>CM</sub> = 0V or (+V<sub>S</sub>), C<sub>L</sub> = 15pF, Full = -40°C to +125°C, typical values are at T<sub>A</sub> = +25°C, unless otherwise noted.)

PARAMETER	SYMBOL	CONDITIONS	TEMP	MIN	TYP	MAX <sup>(1)</sup>	UNITS
Propagation Delay	t <sub>PLH</sub>	V <sub>OD</sub> = 20mV	+25°C		3.5	5.5	µs
			Full			7	
		V <sub>OD</sub> = 100mV	+25°C		2.5	4	
			Full			5.5	
	t <sub>PHL</sub>	V <sub>OD</sub> = 20mV	+25°C		3	4.5	
			Full			5.5	
		V <sub>OD</sub> = 100mV	+25°C		2	3	
			Full			4.5	
Propagation Delay Mismatch	t <sub>SKEW</sub>	V <sub>OD</sub> = 20mV or 100mV	Full		500	1150	ns
Maximum Toggle Frequency	f <sub>MAX</sub>	V <sub>CM</sub> = 0V	+25°C		250		kHz

NOTE:

- Specified by design and characterization, not production tested.

# SGM8778-1 High Voltage, 1.2µA Ultra-Low Current, High Precision, Single Differential Comparator

## TYPICAL PERFORMANCE CHARACTERISTICS

Performance measured with the SGM8778A/B/C/D/E-1 at  $T_A = +25^\circ\text{C}$ , unless otherwise noted.

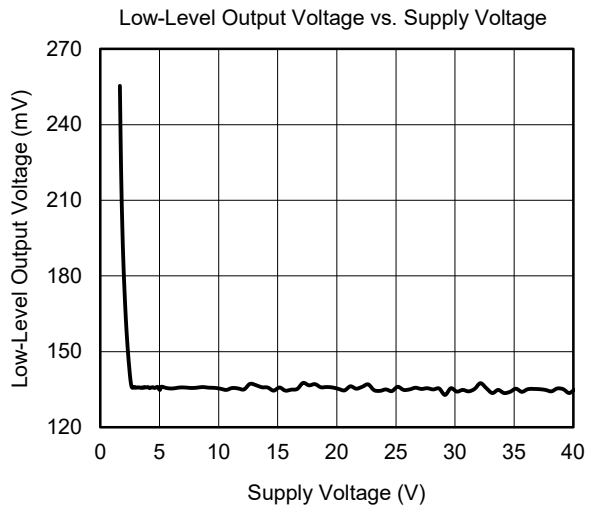
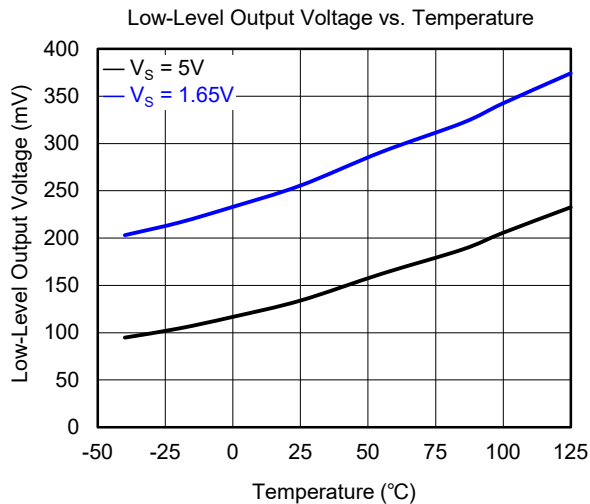
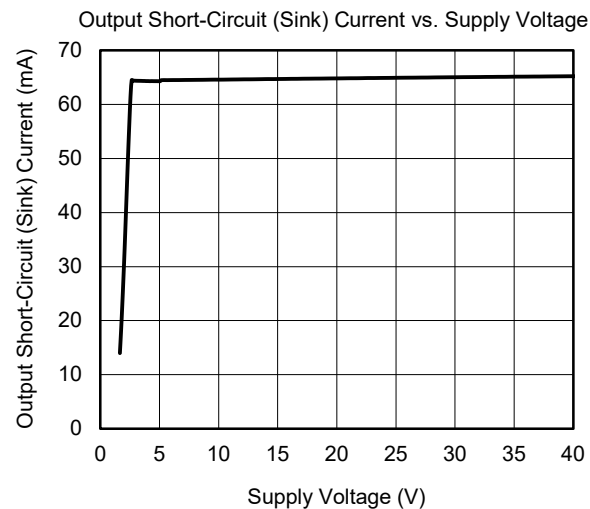
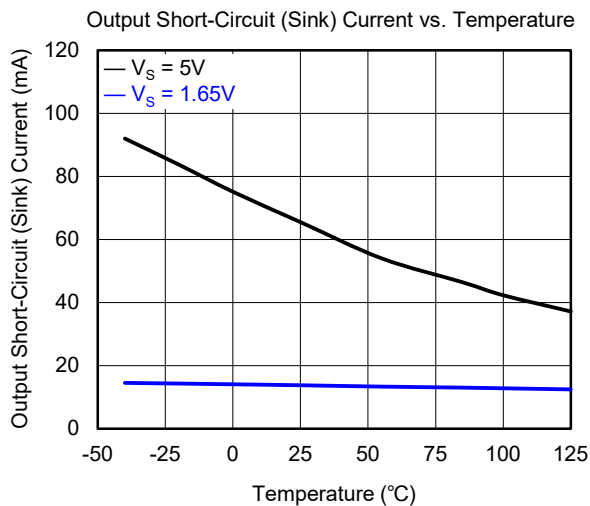
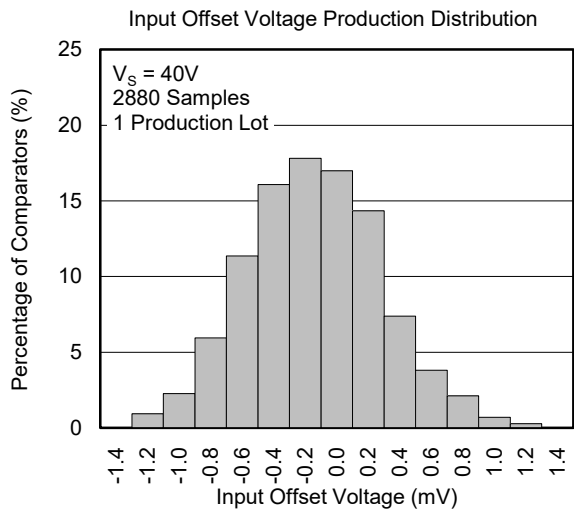
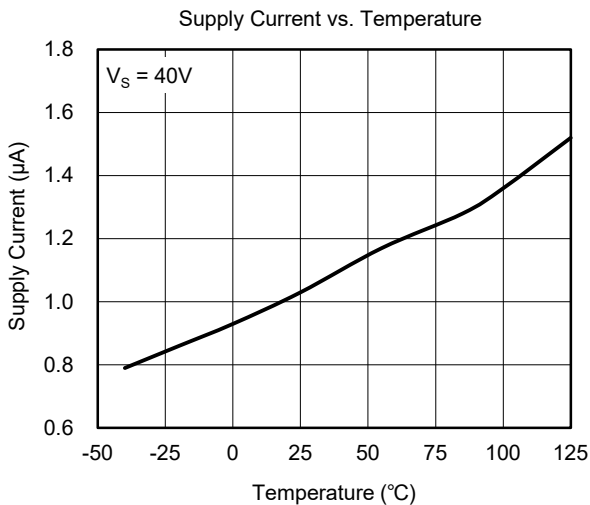

# SGM8778-1 High Voltage, 1.2 $\mu$ A Ultra-Low Current, High Precision, Single Differential Comparator

## TYPICAL PERFORMANCE CHARACTERISTICS (continued)

Performance measured with the SGM8778E-1 at  $T_A = +25^\circ\text{C}$ , unless otherwise noted.

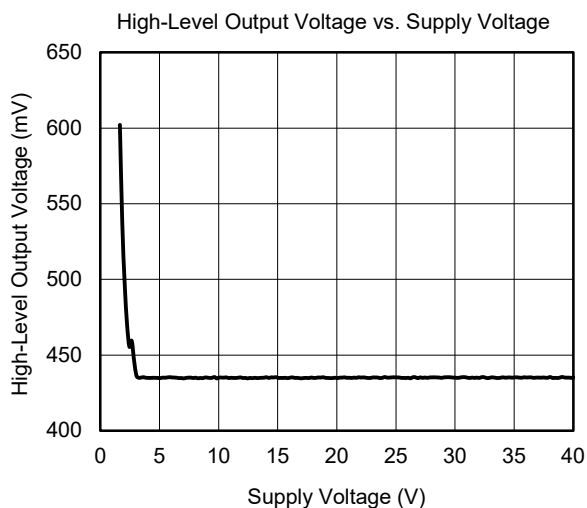
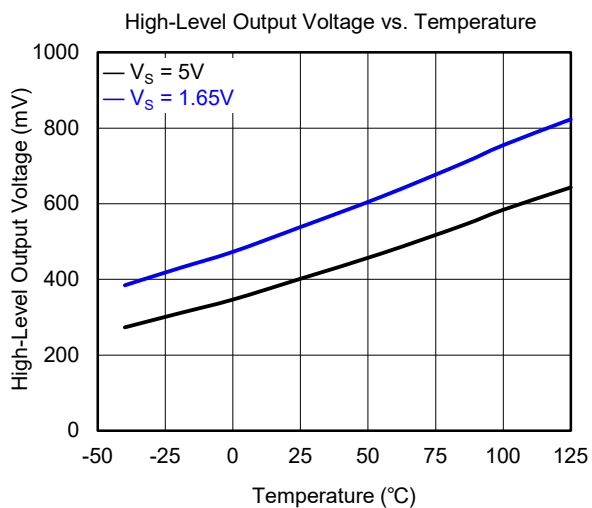
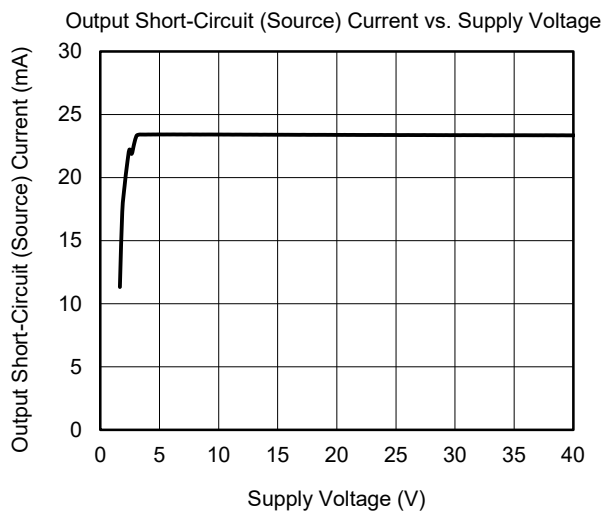
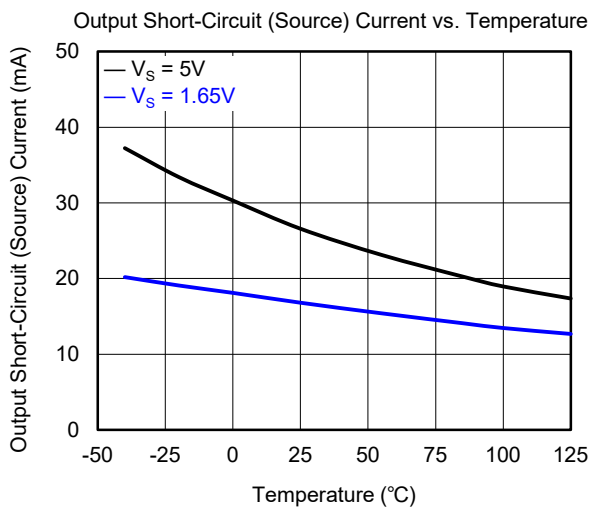



**TYPICAL PERFORMANCE CHARACTERISTICS (continued)**

Performance measured with the SGM8778A/B/C/D-1 at  $T_A = +25^\circ\text{C}$ , unless otherwise noted.

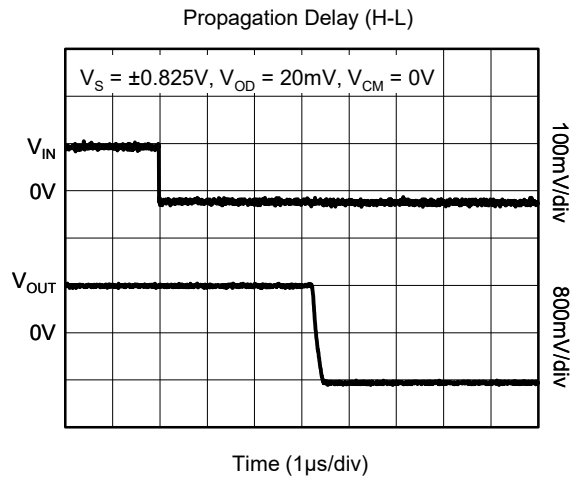
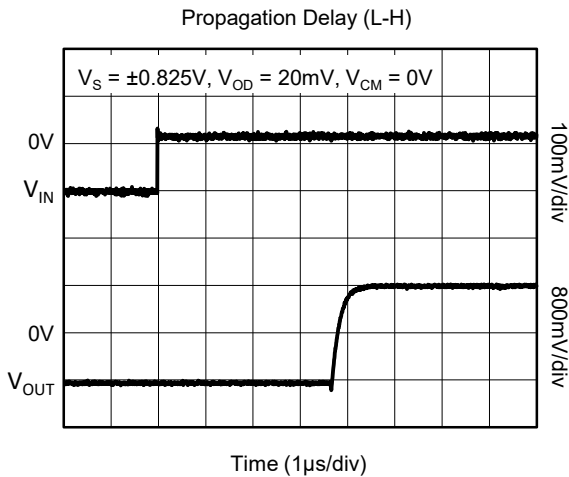
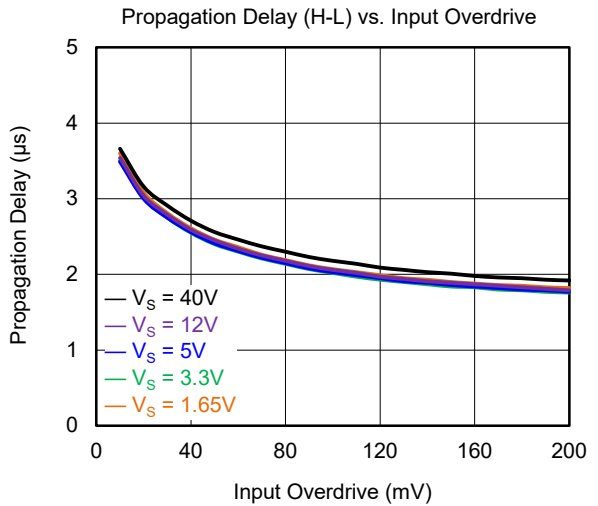
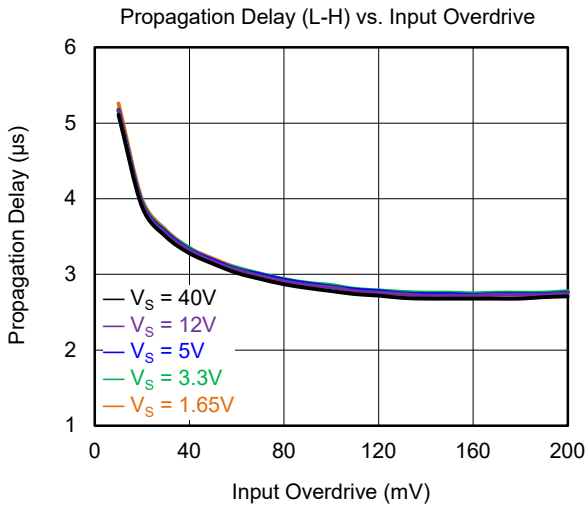
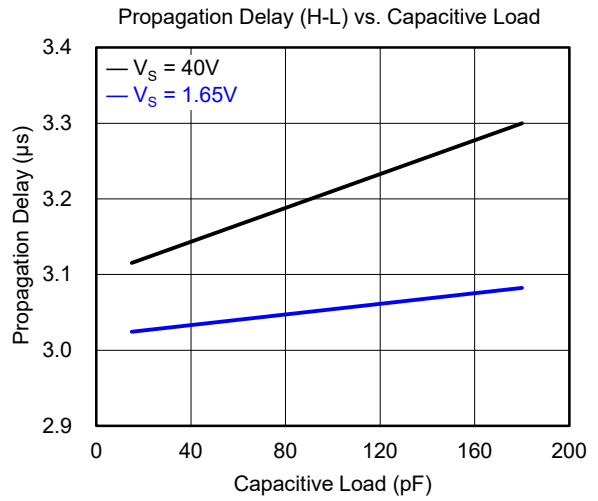
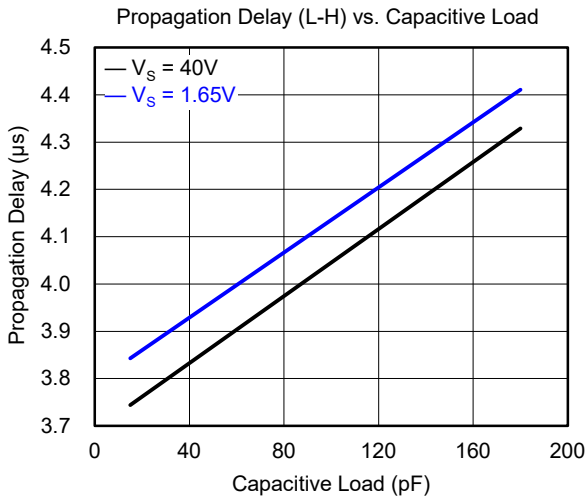

**TYPICAL PERFORMANCE CHARACTERISTICS (continued)**

Performance measured with the SGM8778A/B/C/D-1 at  $T_A = +25^\circ\text{C}$ , unless otherwise noted.

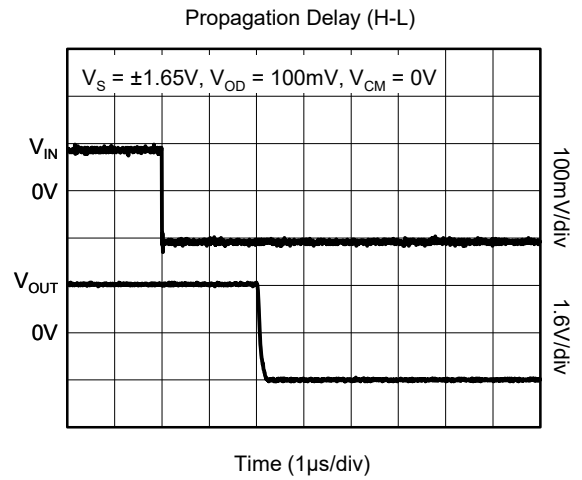
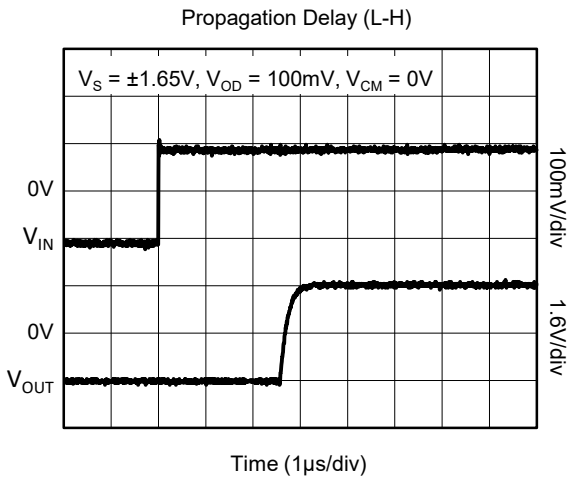
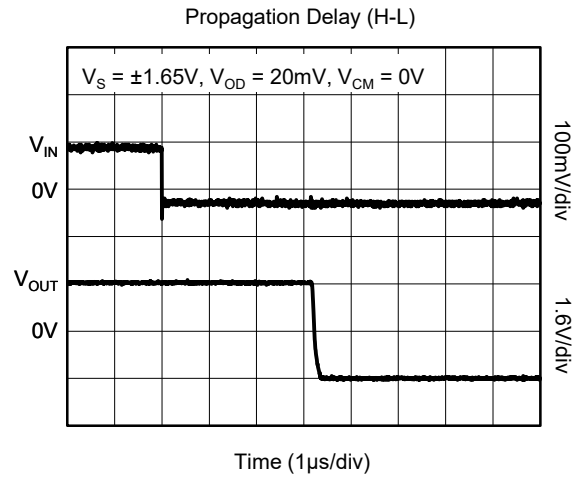
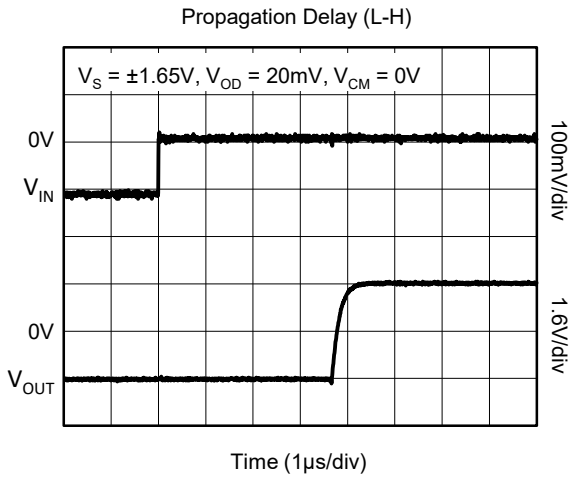
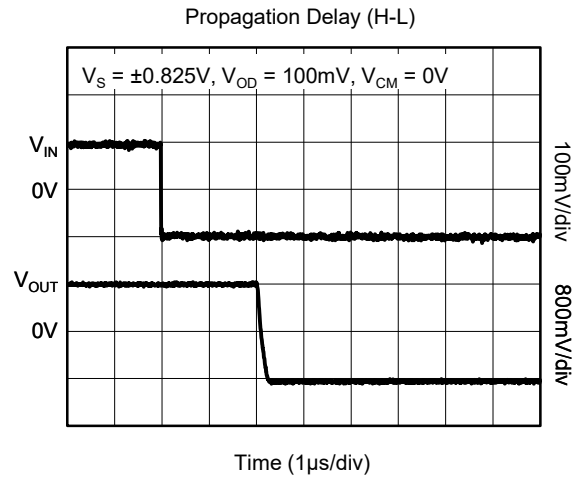
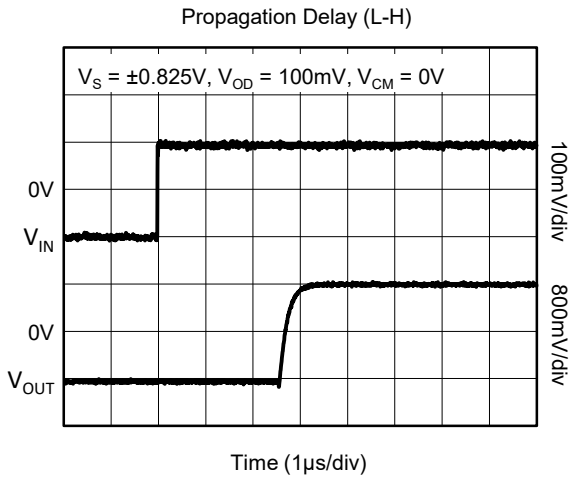

**TYPICAL PERFORMANCE CHARACTERISTICS (continued)**

Performance measured with the SGM8778A/B/C/D-1 at  $T_A = +25^\circ\text{C}$ , unless otherwise noted.

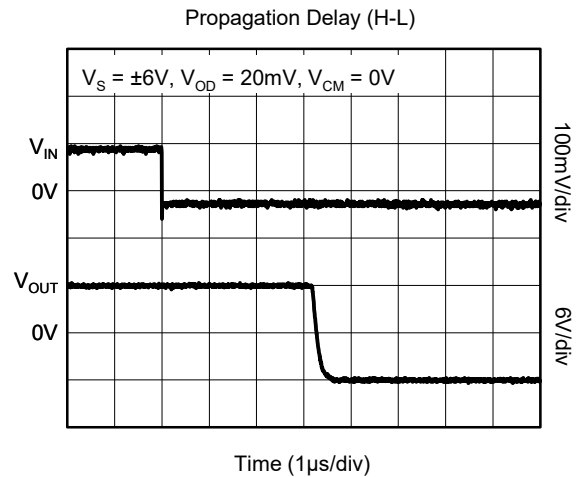
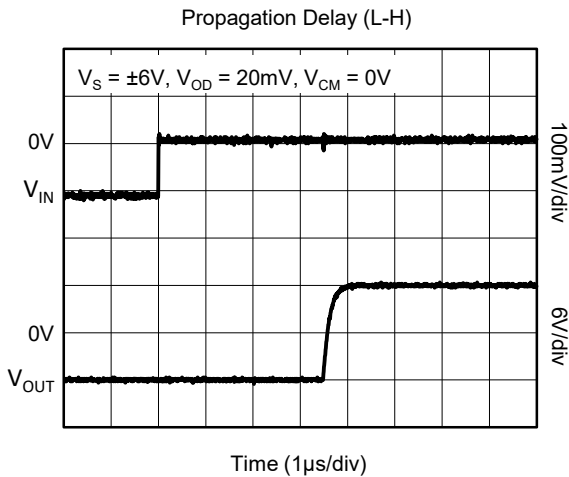
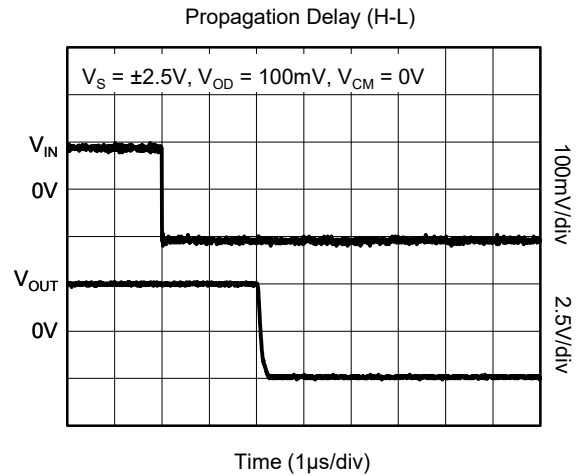
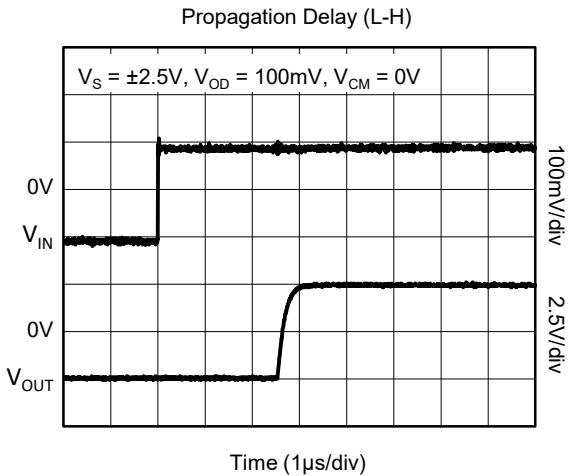
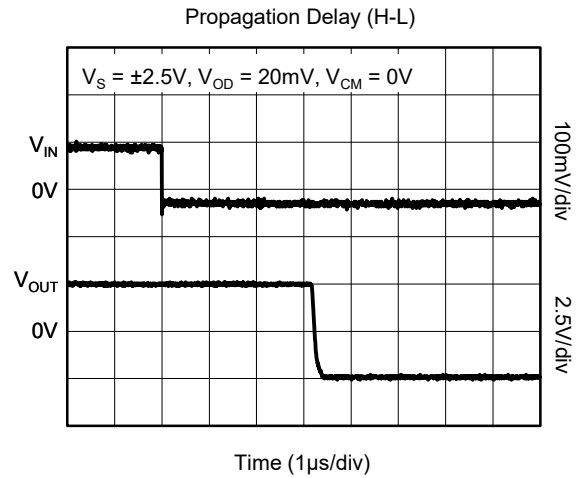
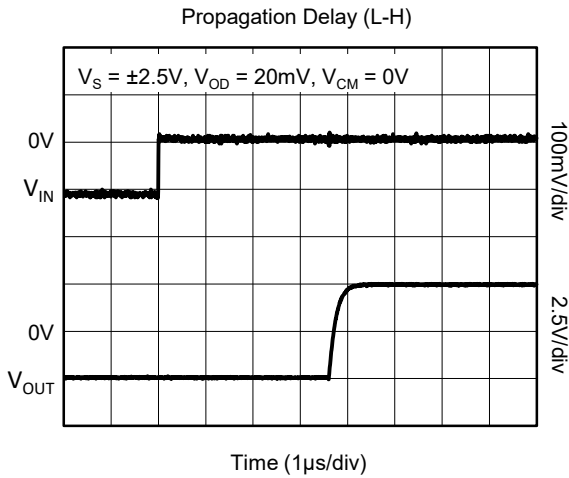

**TYPICAL PERFORMANCE CHARACTERISTICS (continued)**

Performance measured with the SGM8778A/B/C/D-1 at  $T_A = +25^\circ\text{C}$ , unless otherwise noted.

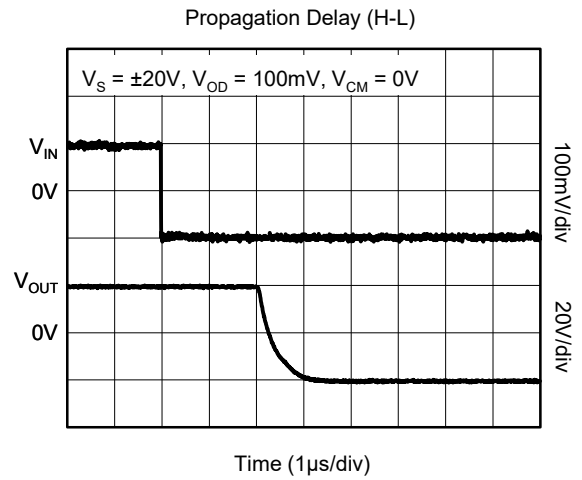
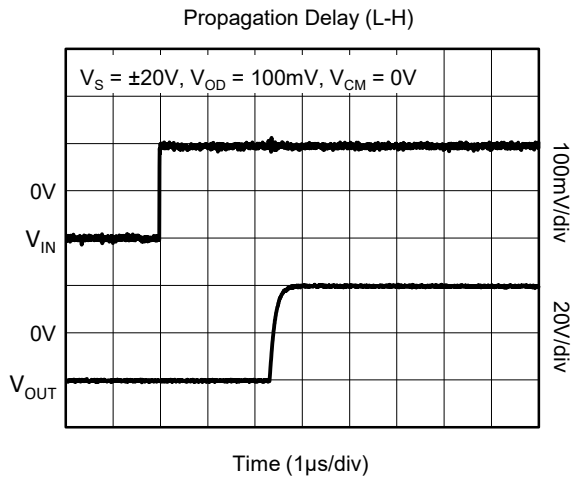
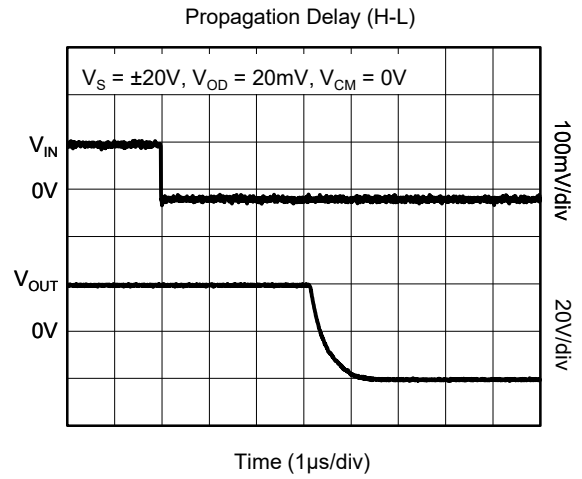
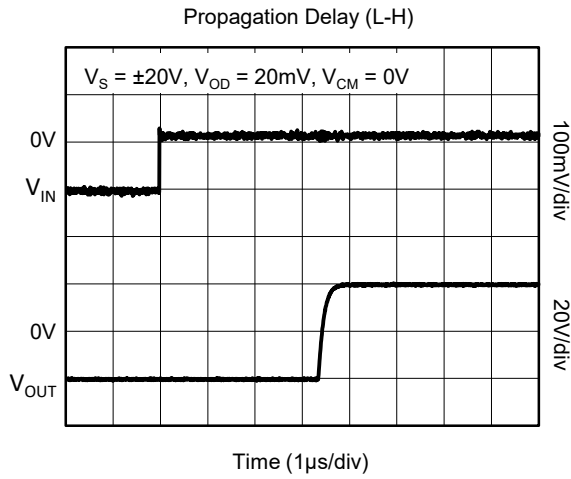
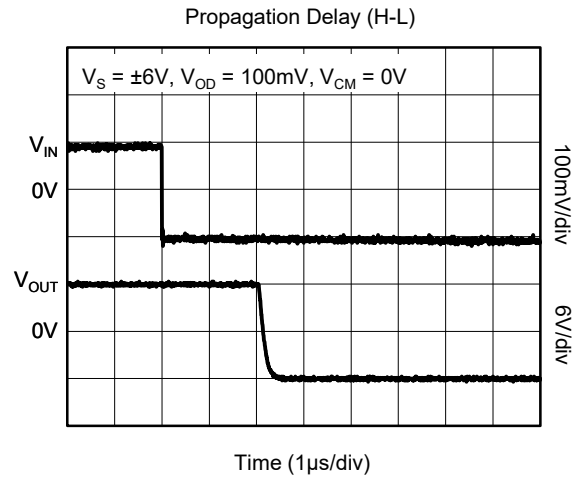
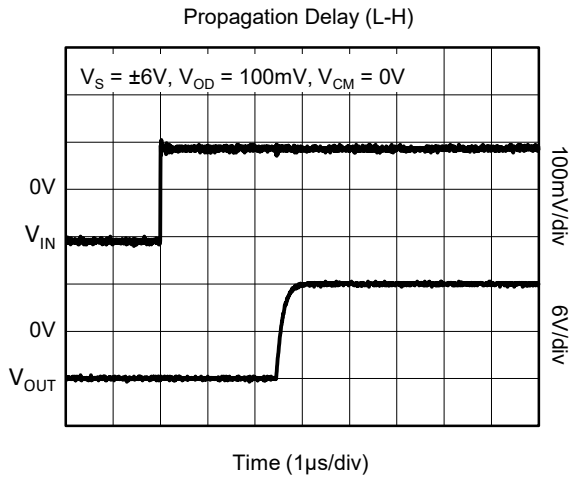

# SGM8778-1 High Voltage, 1.2µA Ultra-Low Current, High Precision, Single Differential Comparator

## TYPICAL PERFORMANCE CHARACTERISTICS (continued)

Performance measured with the SGM8778E-1 at  $T_A = +25^\circ\text{C}$ , unless otherwise noted.

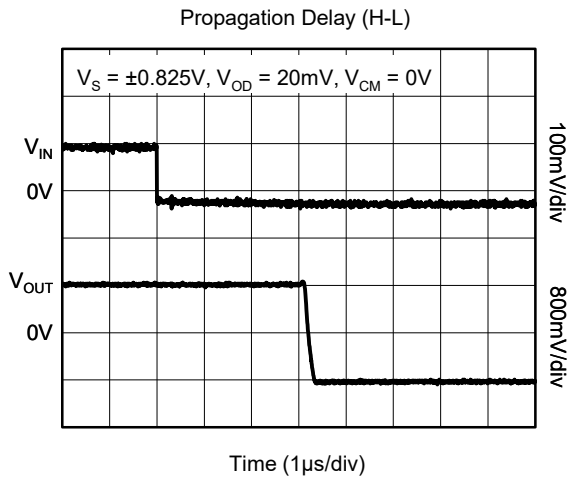
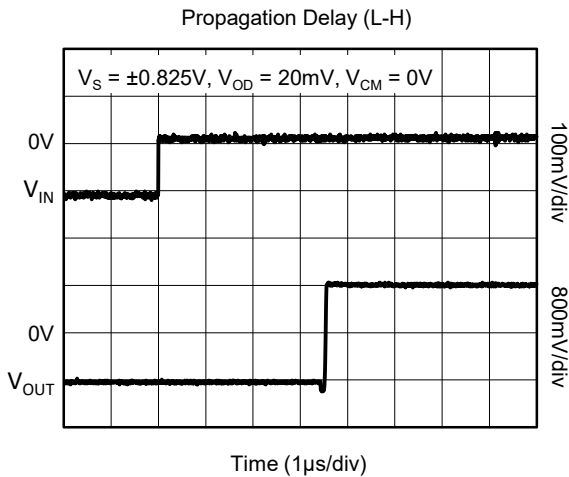
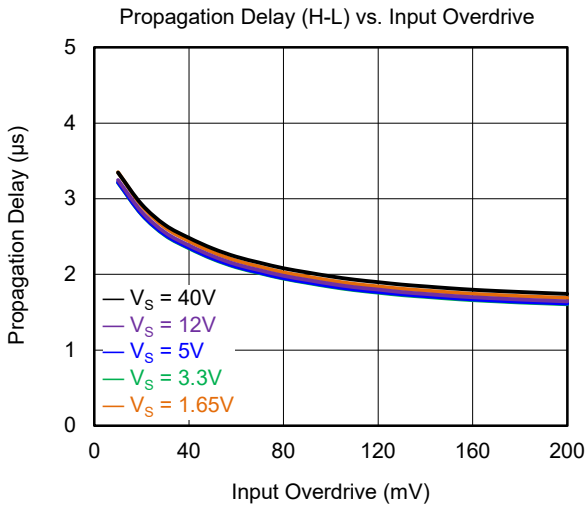
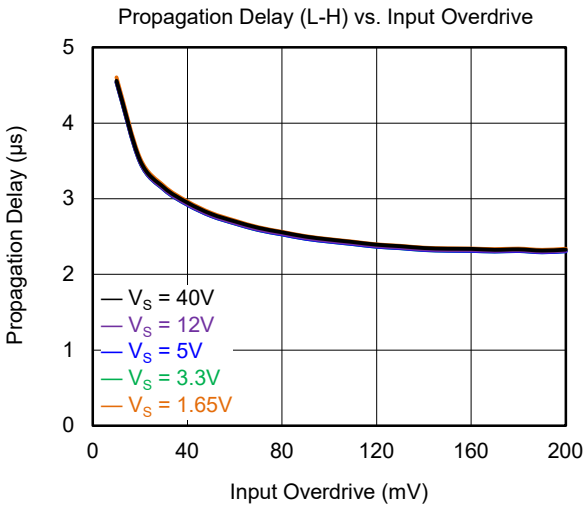
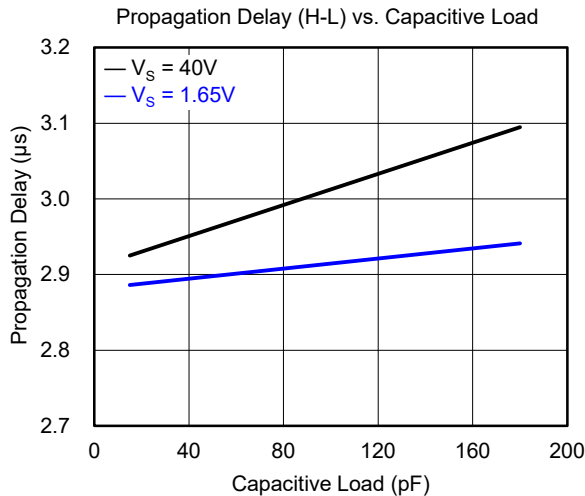
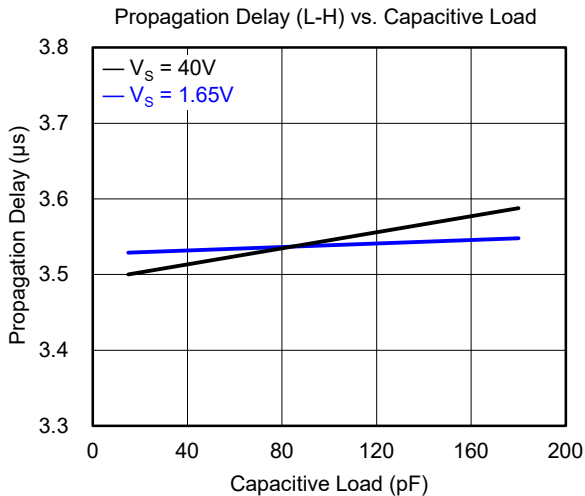

# High Voltage, 1.2 $\mu$ A Ultra-Low Current, High Precision, Single Differential Comparator

## SGM8778-1

### TYPICAL PERFORMANCE CHARACTERISTICS (continued)

Performance measured with the SGM8778E-1 at  $T_A = +25^\circ\text{C}$ , unless otherwise noted.

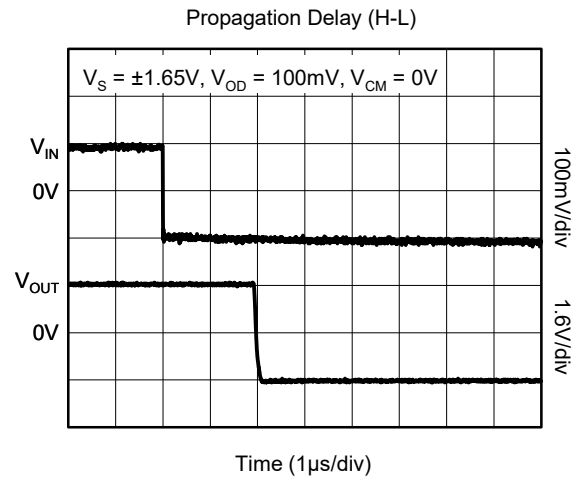
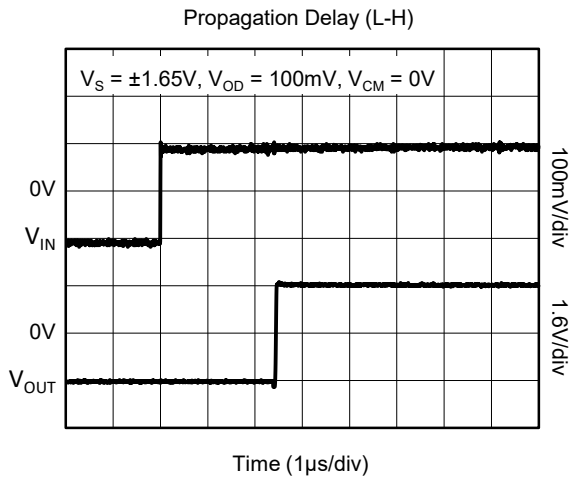
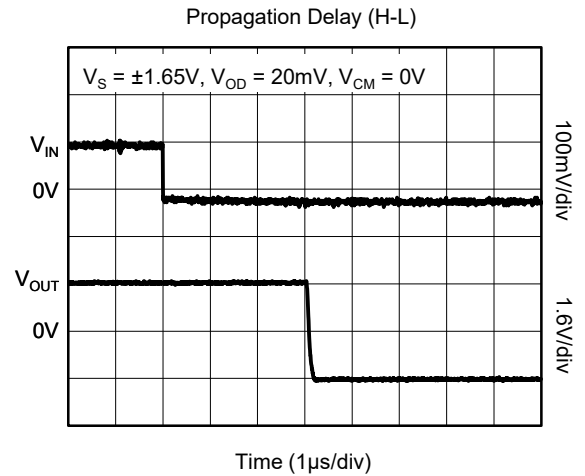
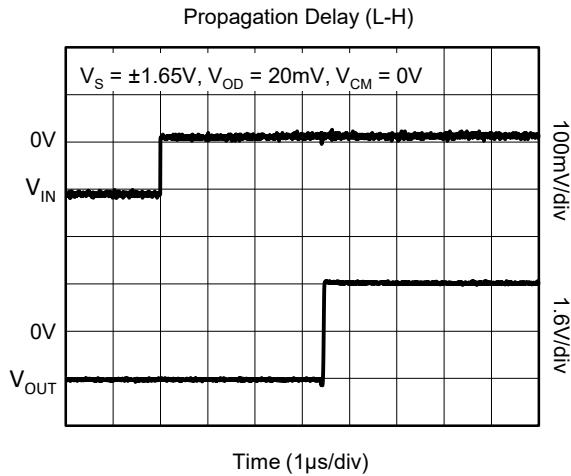
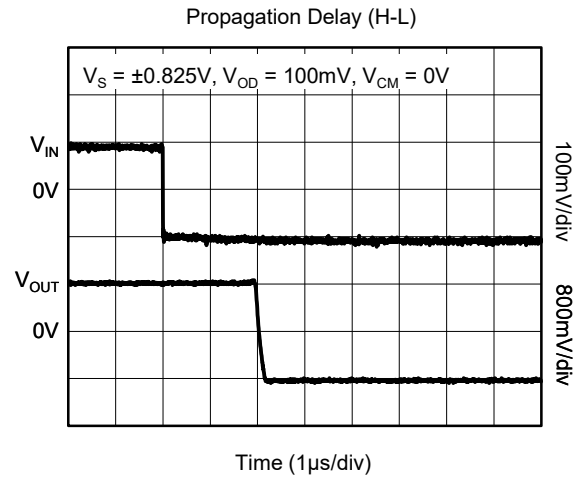
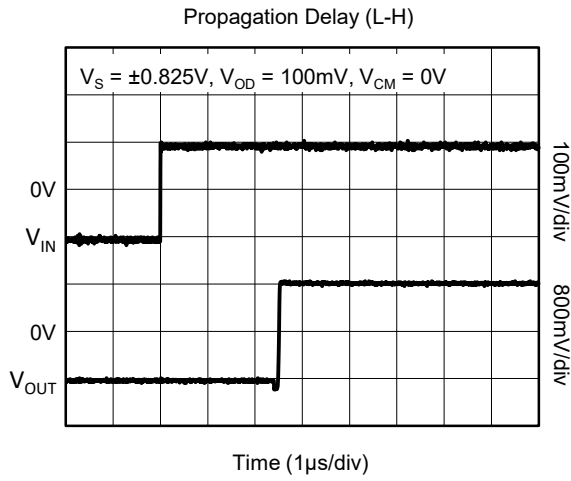

**TYPICAL PERFORMANCE CHARACTERISTICS (continued)**

Performance measured with the SGM8778E-1 at  $T_A = +25^\circ\text{C}$ , unless otherwise noted.

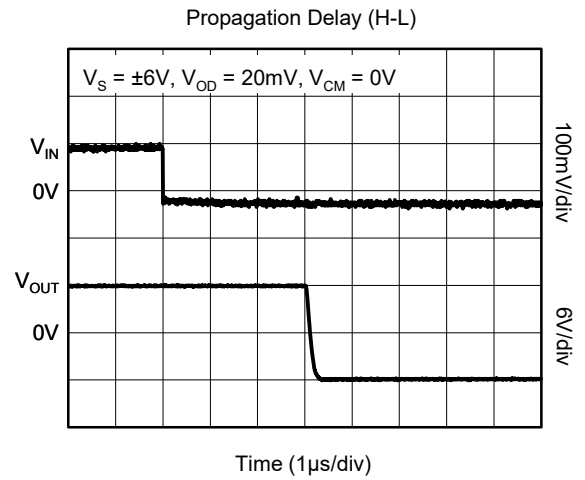
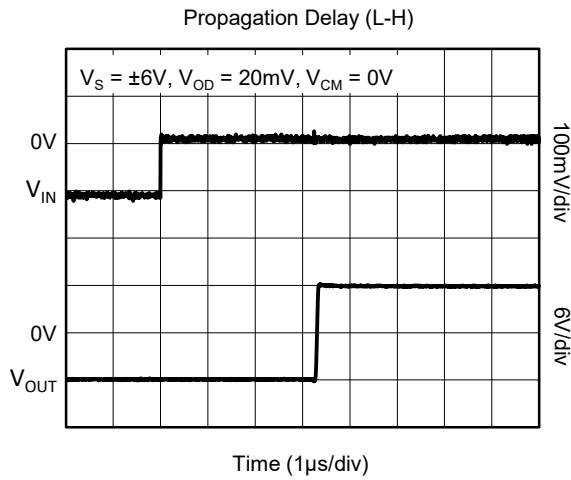
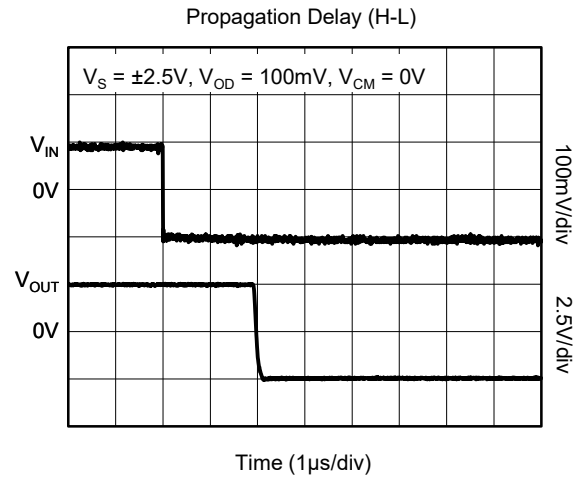
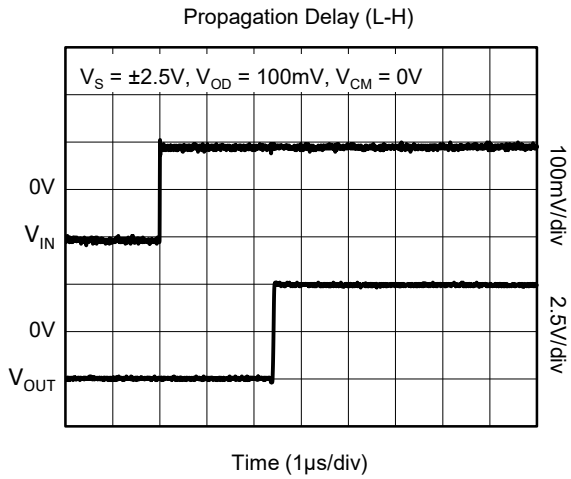
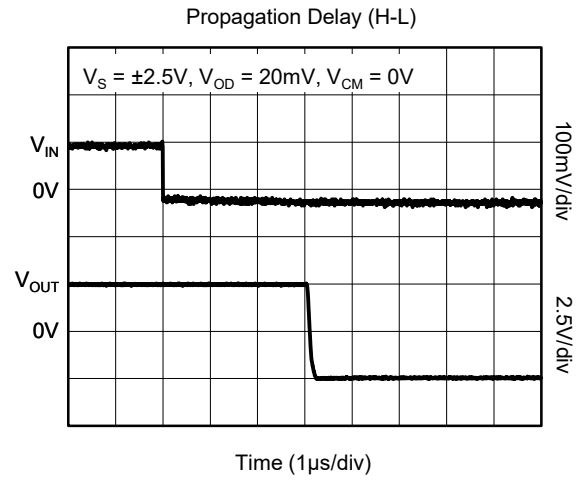
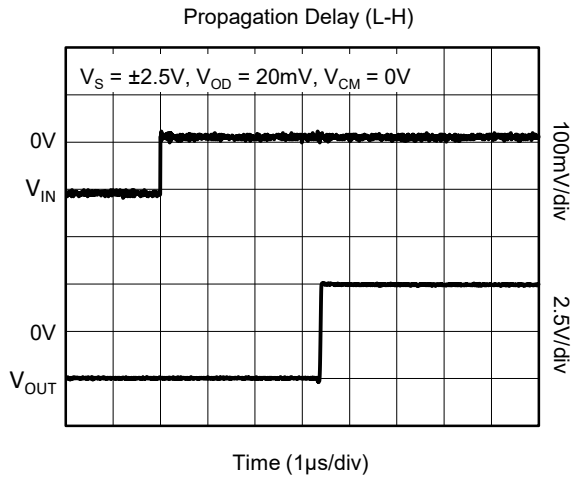

**TYPICAL PERFORMANCE CHARACTERISTICS (continued)**

Performance measured with the SGM8778E-1 at  $T_A = +25^\circ\text{C}$ , unless otherwise noted.

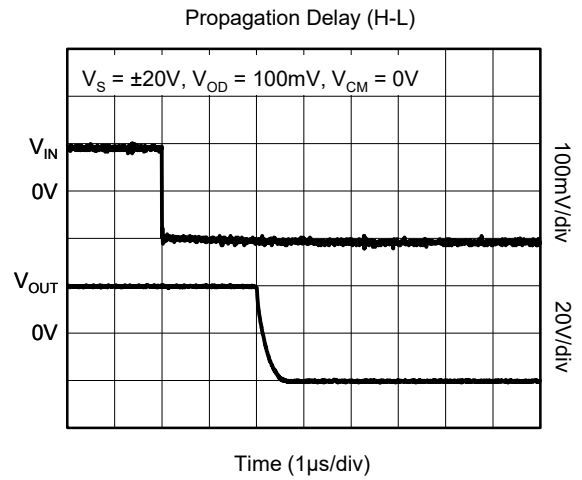
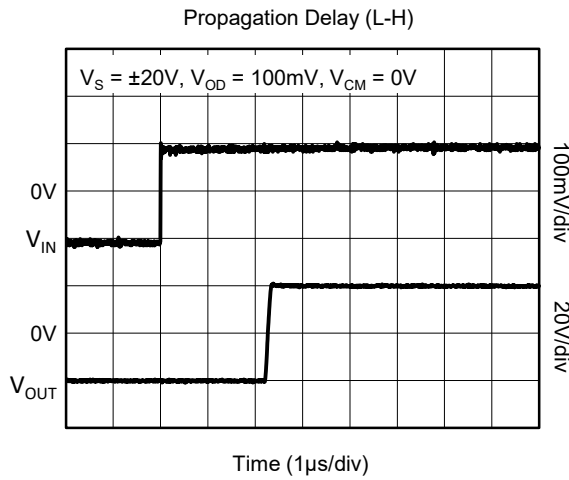
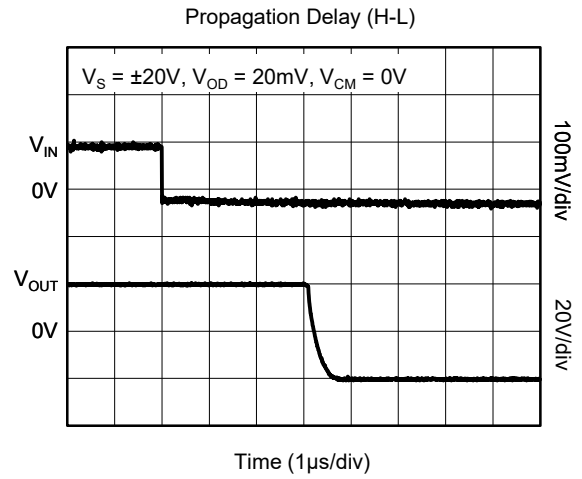
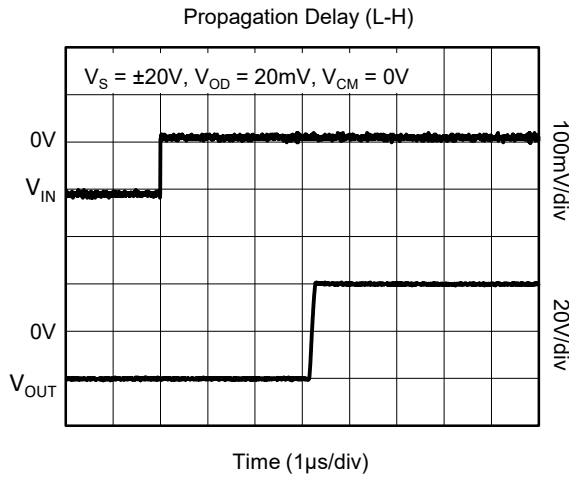
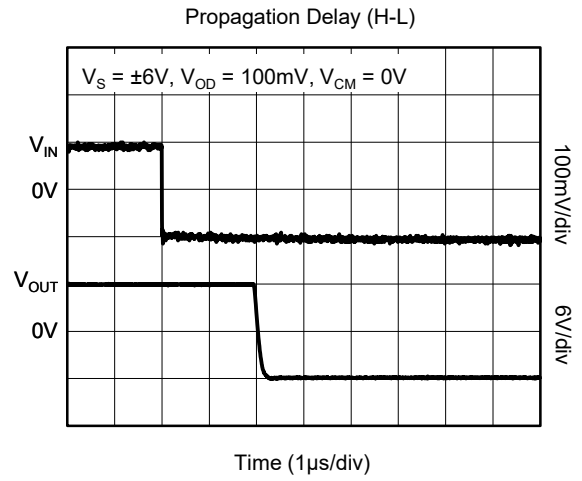
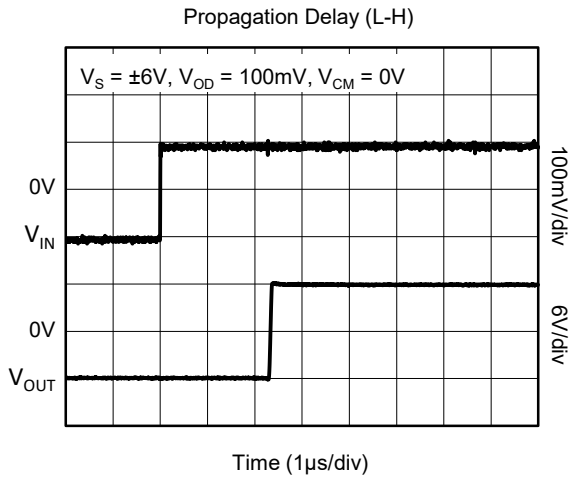



# SGM8778-1 High Voltage, 1.2µA Ultra-Low Current, High Precision, Single Differential Comparator

## DETAILED DESCRIPTION

The SGM8778-1 series is a single, rail-to-rail input, high precision, low power comparator. The wide input voltage range and power supply range make the device a good choice for industrial equipment. The SGM8778A/B/C/D-1 have an open-drain output structure that needs external pull-up resistor. The SGM8778E-1 has a push-pull output structure without external circuits. The SGM8778-1 can be compatible with CMOS and TTL logics.

### Output Structure

In Figure 1, the SGM8778A/B/C/D-1 have a current-driven open-drain output stage. When output is changed from logic high to low, the changed sink current pulls output pin to logic low. Beginning this transition, larger sink current is used to create a high slew rate transit from high to low. Once the output voltage reaches  $V_{OL}$ , it will reduce the sink current to a just right value to maintain the  $V_{OL}$  static condition. In Figure 2, the SGM8778E-1 has a current-driven push-pull output stage. In addition to the above capability of sinking current, it is also capable of sourcing current when driving loads. This current-driven output stage will significantly reduce the power consumption in application system.

If low slew rate transition is needed in system design, adjusting the load capacitance will change the slew rate. The heavier capacitive load will slow down the output voltage transition. This feature will be used to reduce the interference generated by fast edge of transition between 1 and 0 in noise-sensitive system.

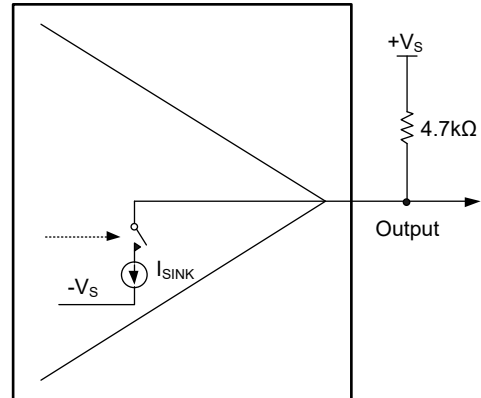

Figure 1. SGM8778A/B/C/D-1 Open-Drain Output Structure

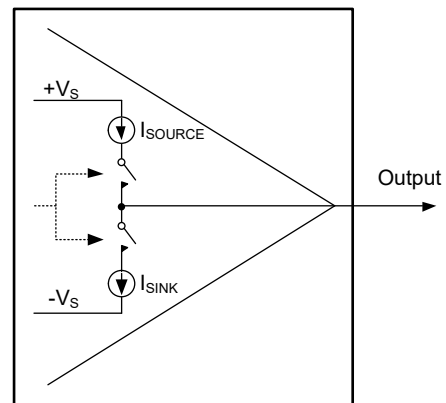

Figure 2. SGM8778E-1 Push-Pull Output Structure

## APPLICATION INFORMATION

### Layout and Bypassing

Good power supply decoupling, layout and grounding are very important for SGM8778-1 to realize the full high-speed capabilities in system, following skills will be used:

- ◆ A 0.1µF to 4.7µF range ceramic capacitor is used to provide good power supply decoupling. This ceramic capacitor must be placed as close to +V<sub>S</sub> pin as possible.

- ◆ For grounding, unbroken and low-inductance ground plane is a good choice.

- ◆ For Layout, use short PCB trace to avoid unwanted parasitic feedback around the comparator. SGM8778-1 must be soldered directly to the PCB and the socket is not recommended.

**REVISION HISTORY**

NOTE: Page numbers for previous revisions may differ from page numbers in the current version.

<b>JUNE 2024 – REV.A to REV.A.1</b>	<b>Page</b>
Added SGM8778A/B/C/E-1 .....	All

---

<b>Changes from Original (JUNE 2024) to REV.A</b>	<b>Page</b>
Changed from product preview to production data.....	All

---

PACKAGE OUTLINE DIMENSIONS

SOT-23-5

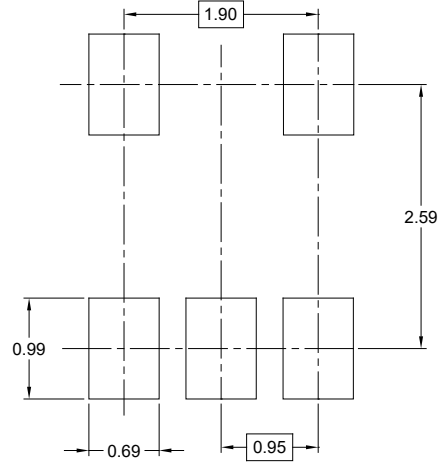
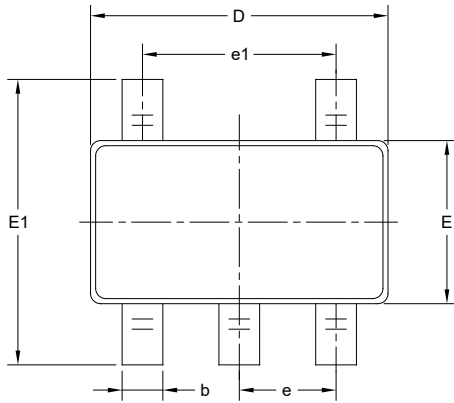

RECOMMENDED LAND PATTERN (Unit: mm)

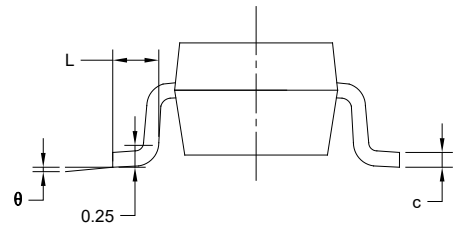
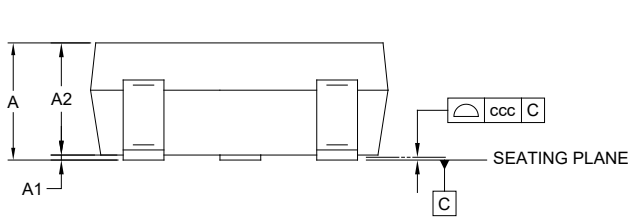

Symbol	Dimensions In Millimeters		
	MIN	MOD	MAX
A	-	-	1.450
A1	0.000	-	0.150
A2	0.900	-	1.300
b	0.300	-	0.500
c	0.080	-	0.220
D	2.750	-	3.050
E	1.450	-	1.750
E1	2.600	-	3.000
e	0.950 BSC		
e1	1.900 BSC		
L	0.300	-	0.600
$\theta$	0°	-	8°
ccc	0.100		

NOTES:

1. This drawing is subject to change without notice.
2. The dimensions do not include mold flashes, protrusions or gate burrs.
3. Reference JEDEC MO-178.

TAPE AND REEL INFORMATION

REEL DIMENSIONS



TAPE DIMENSIONS



NOTE: The picture is only for reference. Please make the object as the standard.

KEY PARAMETER LIST OF TAPE AND REEL

Package Type	Reel Diameter	Reel Width W1 (mm)	A0 (mm)	B0 (mm)	K0 (mm)	P0 (mm)	P1 (mm)	P2 (mm)	W (mm)	Pin1 Quadrant
SOT-23-5	7"	9.5	3.20	3.20	1.40	4.0	4.0	2.0	8.0	Q3

000001

# PACKAGE INFORMATION

## CARTON BOX DIMENSIONS



NOTE: The picture is only for reference. Please make the object as the standard.

## KEY PARAMETER LIST OF CARTON BOX

Reel Type	Length (mm)	Width (mm)	Height (mm)	Pizza/Carton
7" (Option)	368	227	224	8
7"	442	410	224	18

DD0002