



30V N-Channel MOSFETs

General Description

These N-Channel enhancement mode power field effect transistors are using trench DMOS technology. This advanced technology has been especially tailored to minimize on-state resistance, provide superior switching performance, and withstand high energy pulse in the avalanche and commutation mode. These devices are well suited for high efficiency fast switching applications.

BV_{DSS}	$R_{DS(ON)}$	I_D
30V	8.5 mΩ	60 A

Features

- $R_{DS(ON)} \leq 8.5m\Omega @ V_{GS}=10V$
- Improved dv/dt capability
- Fast switching
- Green Device Available

PPAK5X6 Pin Configuration

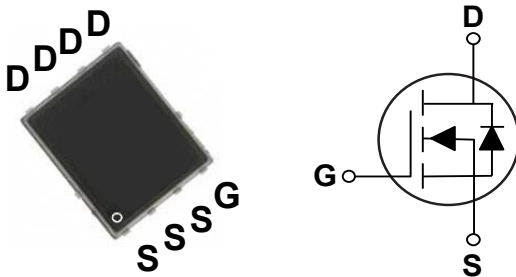

Applications

- MB / VGA / Vcore
- POL Applications
- SMPS 2nd SR

Absolute Maximum Ratings $T_C=25^\circ C$ unless otherwise noted

Symbol	Parameter	Rating	Units
V_{DS}	Drain-Source Voltage	30	V
V_{GS}	Gate-Source Voltage	±20	V
I_D	Drain Current - Continuous ($T_C=25^\circ C$)	60	A
	Drain Current - Continuous ($T_C=100^\circ C$)	38	A
I_{DM}	Drain Current - Pulsed (NOTE 1)	240	A
EAS	Single Pulse Avalanche Energy (NOTE 2)	31	mJ
IAS	Single Pulse Avalanche Current (NOTE 2)	25	A
P_D	Power Dissipation ($T_C=25^\circ C$)	54	W
	Power Dissipation - Derate above 25°C	0.43	W/°C
T_J	Operating Junction Temperature Range	-50 to 150	°C
T_{STG}	Storage Temperature Range	-50 to 150	°C
Marking Code		NC8P5	

Thermal Characteristics

Symbol	Parameter	Typ.	Max	Unit
$R_{\theta JA}$	Thermal Resistance Junction to Ambient	---	62	°C/W
$R_{\theta JC}$	Thermal Resistance Junction to Case	---	2.3	°C/W

**Electrical Characteristics ($T_J=25^\circ\text{C}$, unless otherwise noted)****Off Characteristics**

Symbol	Parameter	Conditions	Min.	Typ.	Max.	Unit
BV_{DSS}	Drain-Source Breakdown Voltage	$V_{GS}=0V, I_D=250\mu A$	30	---	---	V
I_{DSS}	Drain-Source Leakage Current	$V_{DS}=24V, V_{GS}=0V, T_J=25^\circ\text{C}$	---	---	1	μA
		$V_{DS}=24V, V_{GS}=0V, T_J=125^\circ\text{C}$	---	---	10	μA
I_{GSS}	Gate-Source Leakage Current	$V_{GS}=\pm 20V, V_{DS}=0V$	---	---	± 100	nA

On Characteristics

Symbol	Parameter	Conditions	Min.	Typ.	Max.	Unit
$R_{DS(ON)}$	Static Drain-Source On-Resistance (NOTE 3)	$V_{GS}=10V, I_D=15A$	---	---	8.5	m Ω
		$V_{GS}=4.5V, I_D=8A$	---	---	11	
$V_{GS(th)}$	Gate Threshold Voltage	$V_{GS}=V_{DS}, I_D=250\mu A$	1.2	1.6	2.5	V
gfs	Forward Transconductance	$V_{DS}=10V, I_D=8A$	---	5.6	---	S

Dynamic and switching Characteristics

Symbol	Parameter	Conditions	Min.	Typ.	Max.	Unit
Q_g	Total Gate Charge	$V_{DS}=15V, V_{GS}=10V, I_D=1A$	---	23.2	---	nC
Q_{gs}	Gate-Source Charge		---	3.2	---	
Q_{gd}	Gate-Drain Charge		---	3.7	---	
$T_{d(on)}$	Turn-On Delay Time	$V_{DD}=10V, V_{GS}=10V, R_{GEN}=2.7\Omega, I_D=30A$	---	7	---	nS
T_r	Rise Time		---	76.6	---	
$T_{d(off)}$	Turn-Off Delay Time		---	27.1	---	
T_f	Fall Time		---	52.6	---	
C_{iss}	Input Capacitance	$V_{DS}=15V, V_{GS}=0V, F=1\text{MHz}$	---	1180	---	pF
C_{oss}	Output Capacitance		---	177	---	
C_{rss}	Reverse Transfer Capacitance		---	132	---	
R_g	Gate Resistance	$V_{GS}=0V, V_{DS}=0V, F=1\text{MHz}$	---	3.2	---	Ω

Drain-Source Diode Characteristics and Ratings

Symbol	Parameter	Conditions	Min.	Typ.	Max.	Unit
I_S	Continuous Source Current	$V_G=V_D=0V$, Force Current	---	---	60	A
I_{SM}	Pulsed Source Current		---	---	240	A
V_{SD}	Diode Forward Voltage	$V_{GS}=0V, I_S=1A, T_J=25^\circ\text{C}$	---	---	1	V

NOTES :

1. Repetitive Rating : Pulsed width limited by maximum junction temperature.
2. $V_{DD}=25V, V_{GS}=10V, L=0.1\text{mH}, I_{AS}=25A, R_G=25\Omega$, Starting $T_J=25^\circ\text{C}$.
3. The data tested by pulsed, pulse width $\leq 300\mu s$, duty cycle $\leq 2\%$.
4. Essentially independent of operating temperature.



Characteristics Curves

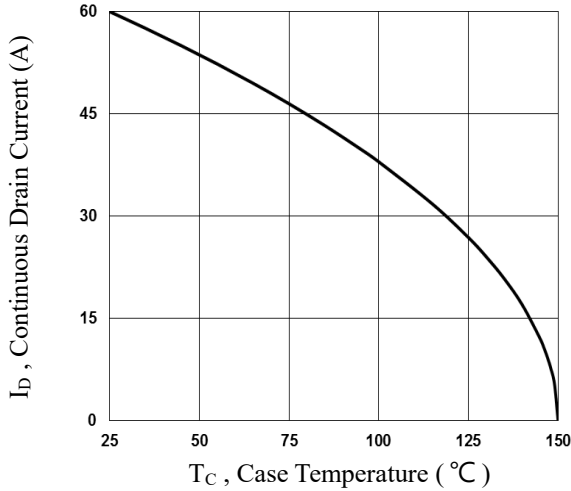

Fig.1 Continuous Drain Current vs. T_C

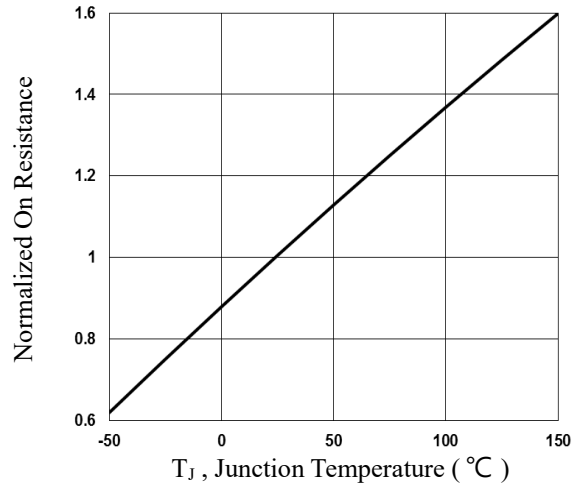

Fig.2 Normalized $R_{DS(on)}$ vs. T_J

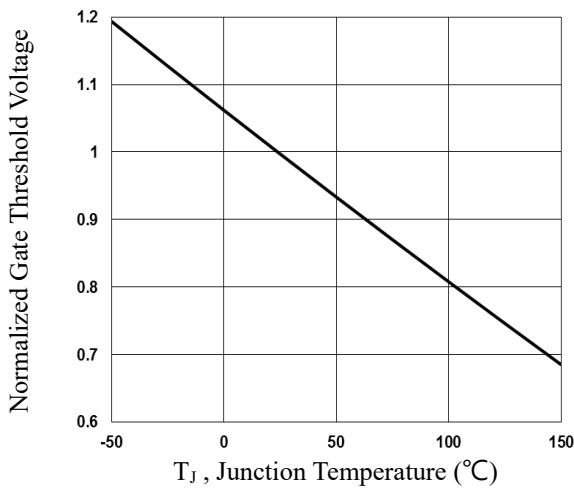

Fig.3 Normalized V_{th} vs. T_J

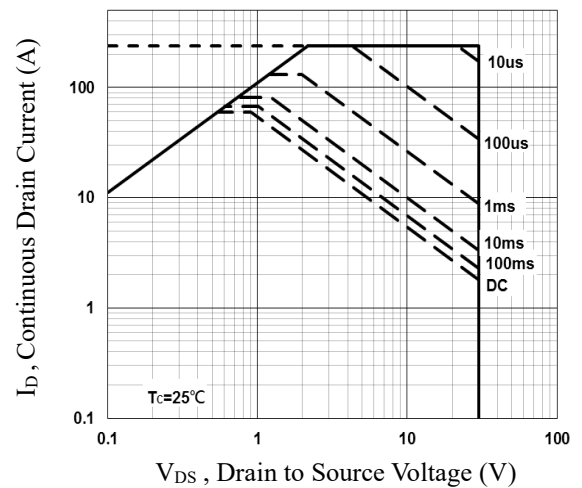

Fig.4 Maximum Safe Operation Area

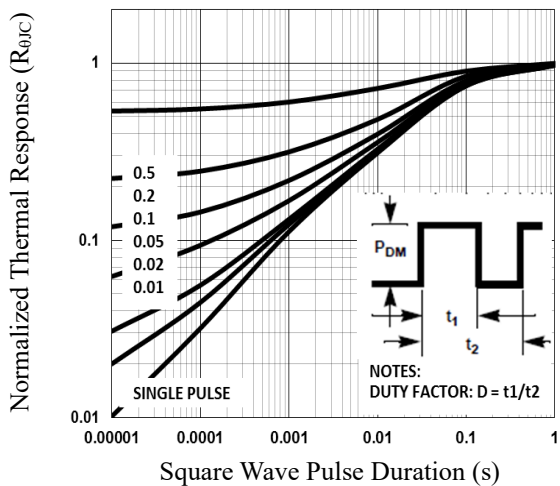

Fig.5 Normalized Transient Impedance

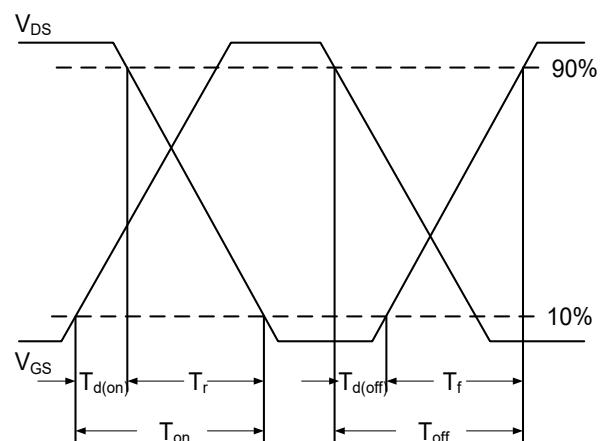

Fig.6 Switching Time Waveform



Characteristics Curves

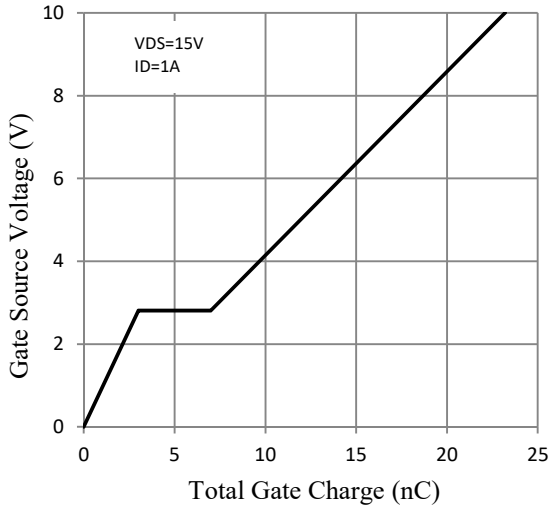
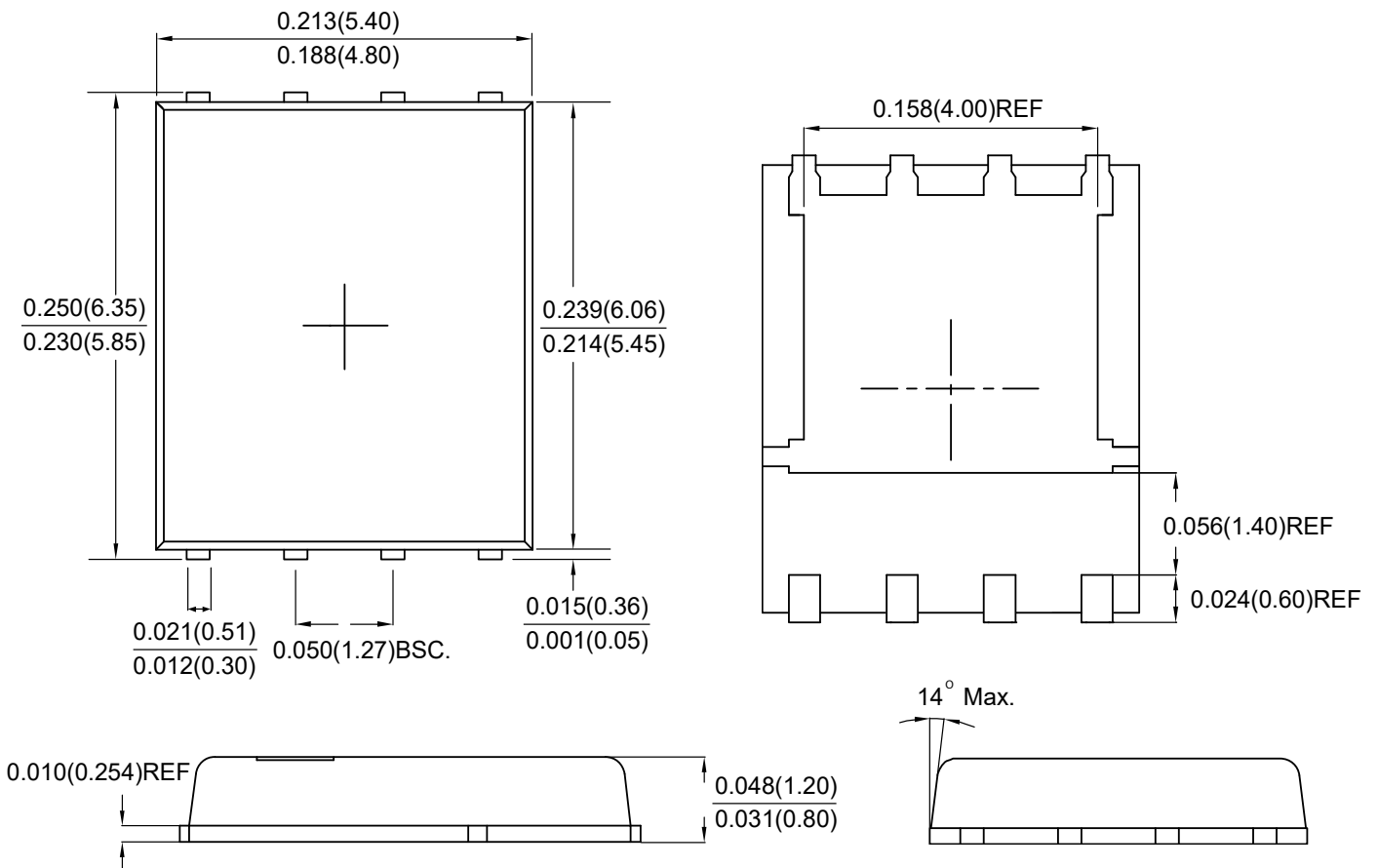

FIG. 7 Gate Charge Characteristics

Package Outline Dimensions



PPAK5X6

Dimensions in inches and (millimeters)



LEGAL DISCLAIMER

- The product is provided “AS IS” without any guarantees or warranty. In association with the product, Eris Technology Corporation, its affiliates, and their directors, officers, employees, agents, successors and assigns (collectively, the “Eris”) makes no warranties of any kind, either express or implied, including but not limited to warranties of merchantability, fitness for a particular purpose, of title, or of non-infringement of third party rights.
- The information in this document and any product described herein are subject to change without notice and should not be construed as a commitment by Eris. Eris assumes no responsibility for any errors that may appear in this document.
- Eris does not assume any liability arising out of the application or use of this document or any product described herein, any Customer or user of this document or products described herein in such applications shall assume all risks of such use and will agree to hold Eris and all the companies whose products are represented on Eris website, harmless against all damages.
- No license, express or implied, by estoppels or otherwise, to any intellectual property is granted by this document or by any conduct of Eris. Product name and markings notes herein may be trademarks of their respective owners.
- Eris does not warrant or accept any liability whatsoever in respect of any products purchased through unauthorized sales channel.
- Should Customers purchase or use Eris products for any unintended or unauthorized application, Customers shall indemnify and hold Eris and its representatives harmless against all claims, damages, expenses, and attorney fees arising out of, directly or indirectly, any claim of personal injury or death associated with such unintended or unauthorized application.
- The official text is written in English and the English version of this document is the only version endorsed by Eris. Any discrepancies or differences created in the translations are not binding and have no legal effect on Eris for compliance or enforcement purposes.