

## 2channel MOSFET Drive Switching Regulator IC for Buck Converter

### ■ GENERAL DESCRIPTION

The **NJW4162A** is a 2 channel MOSFET Drive switching regulator IC for buck converter that operates wide input voltage range from 4.3V to 40V. The oscillating frequency range can set within 100kHz to 1MHz by external resistor. It also has an external synchronous function.

It has individual Standby functions, Soft Start functions and Power Good functions for each channel, therefore a start-up control and/or operating condition monitoring are available with a microcomputer.

The **NJW4162A** is suitable for a logic voltage generating circuit from high input voltage such as Automotive. Office Automation and Industrial applications.

### ■ PACKAGE OUTLINE

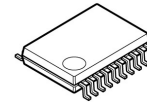

**NJW4162AVC3**

### ■ FEATURES

- Pch MOSFET Driving                      Driving Voltage  $V^+$ -10V(typ.)
- Maximum Rating Input Voltage        45V
- Wide Operating Voltage Range        4.3V to 40V
- PWM Control
- Maximum Duty Cycle 100%
- Wide Oscillating Frequency Range    100kHz to 1MHz
- External Synchronization Function    1,500kHz (max.)
- Anti-Phase switching
- Adjustable Soft Start Function
- UVLO (Under Voltage Lockout)
- Over Current Protection (Hiccup type)
- Thermal Shutdown Protection
- Standby Function
- Power Good Function
- Package Outline                            NJW4162AVC3 : SSOP20-C3

# NJW4162A

## ■ PIN CONFIGURATION

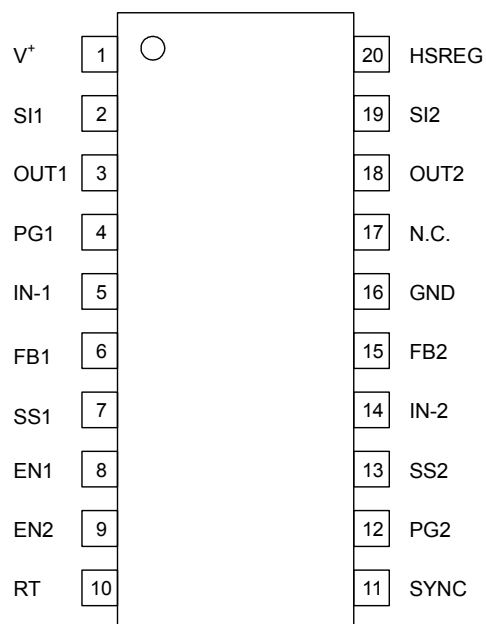

(Top View)

**NJW4162AVC3**

## ■ PIN DESCRIPTIONS

PIN NAME	PIN NUMBER	FUNCTION
V <sup>+</sup>	1	Power Supply pin
SI1 SI2	2 19	Current Sensing pin When voltage difference between the V <sup>+</sup> pin and the SI pin exceeds 150mV(typ.), over current protection operates.
OUT1 OUT2	3 18	Output pin for Power MOSFET Driving The OUT pin Voltage is clamped with V <sup>+</sup> -10V(typ.) at the time of Low level, in order to protect a gate of Pch MOSFET.
PG1 PG2	4 12	Power Good pin. An open drain output that goes high impedance when the IN- pin voltage is stable around ±10%.
IN-1 IN-2	5 14	Output Voltage Detecting pin Connects output voltage through the resistor divider tap to this pin in order to voltage of the IN- pin become 0.8V.
FB1 FB2	6 15	Feedback Setting pin The feedback resistor and capacitor are connected between the FB pin and the IN- pin.
SS1 SS2	7 13	Soft Start timer setting pin. Soft start time is controlled by a capacitor.
EN1 EN2	8 9	Standby Control pin The EN pin internally pulls down with 500kΩ. Normal Operation at the time of High Level. Standby Mode at the time of Low Level or OPEN.
RT	10	Oscillating Frequency Setting pin by Timing Resistor. Oscillating Frequency should set between 100kHz and 1MHz.
SYNC	11	External Clock Input pin. The SYNC pin internally pulls down with 500kΩ. It operates by inputting clock signal at the oscillatory frequency that synchronized with the input signal. When not using the external synchronization function, make the SYNC pin the Low level or open.
GND	16	GND pin
N.C.	17	Non Connection
HSREG	20	Output pin of the high side regulator. Connect a bypass capacitor to stabilize a driver circuit.

# NJW4162A

## ■ BLOCK DIAGRAM

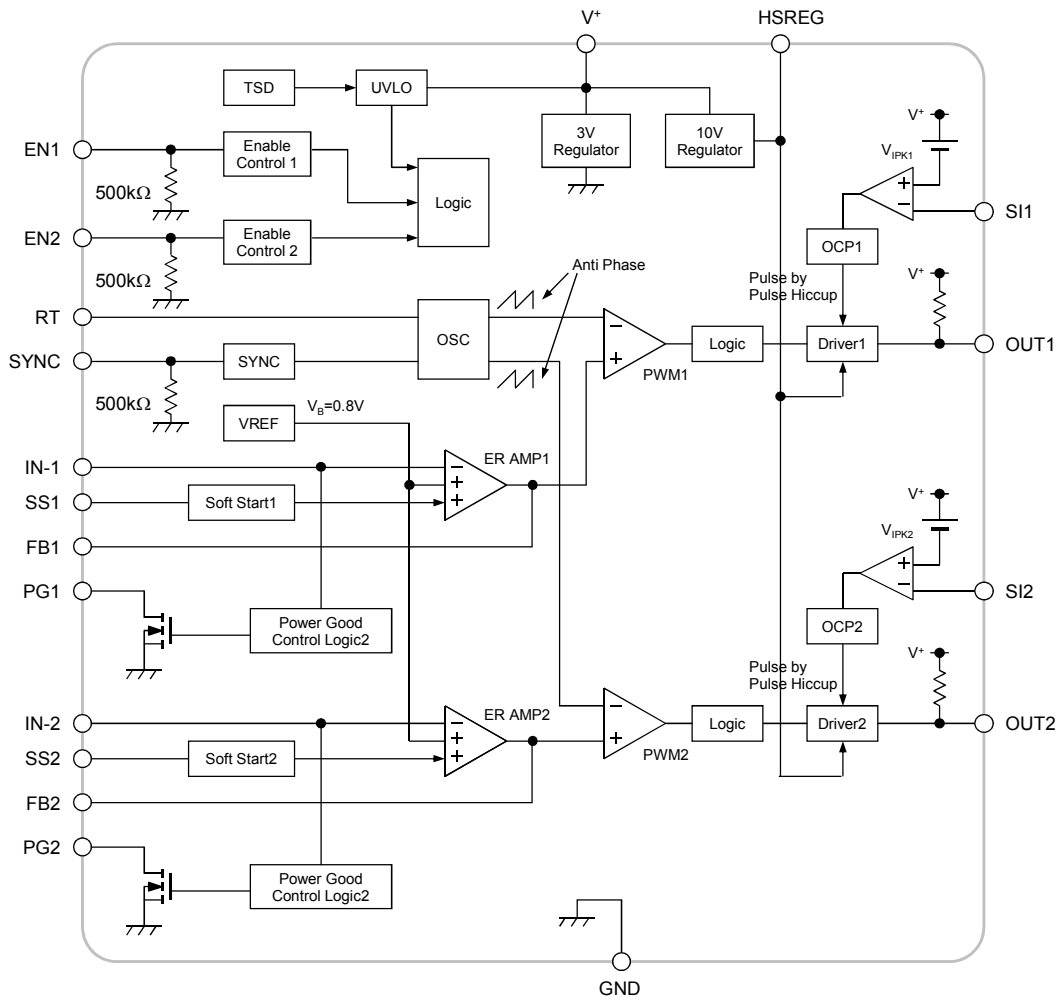

## ■ ABSOLUTE MAXIMUM RATINGS

(Ta=25°C)

PARAMETER	SYMBOL	MAXIMUM RATINGS	UNIT
Supply Voltage	$V^+$	-0.3 to +45	V
OUT1,2 pin Voltage	$V_{OUT1,2}$	$V^+ - 11$ to $V^+$ (*1)	V
EN1,2 pin Voltage	$V_{EN1,2}$	-0.3 to +45	V
IN-1,2 pin Voltage	$V_{IN-1,2}$	-0.3 to +6	V
Power Good1,2 pin Voltage	$V_{PG1,2}$	-0.3 to +6	V
SYNC pin Voltage	$V_{SYNC}$	-0.3 to +6	V
OUT pin Peak Current	$I_{O\_PEAK+}$	1,000 (Source)	mA
	$I_{O\_PEAK-}$	1,000 (Sink)	mA
Power Dissipation	$P_D$	SSOP20    1,000 (*2) 1,500 (*3)	mW
Junction Temperature Range	$T_j$	-40 to +150	°C
Operating Temperature Range	$T_{opr}$	-40 to +125	°C
Storage Temperature Range	$T_{stg}$	-50 to +150	°C

(\*1): When Supply voltage is less than +11V, the absolute maximum rating is -0.3 to  $V^+$ .

(\*2): Mounted on glass epoxy board. (76.2×114.3×1.6mm:based on EIA/JDEC standard, 2Layers)

(\*3): Mounted on glass epoxy board. (76.2×114.3×1.6mm:based on EIA/JDEC standard, 4Layers),

internal Cu area: 74.2×74.2mm

## ■ RECOMMENDED OPERATING CONDITIONS

PARAMETER	SYMBOL	MIN.	TYP.	MAX.	UNIT
Supply Voltage	$V^+$	4.3	–	40	V
Timing Resistor	$R_T$	4.3	–	56	kΩ
Oscillating Frequency	$f_{OSC}$	100	–	1,000	kHz
Power Good pin Voltage	$V_{PG}$	0	–	5.5	V
External Clock Input Range	$f_{SYNC}$	$f_{OSC} \times 1.1$	–	1,500 (*4)	kHz
HSREG Capacitor	$C_{HSREG}$	0.01	0.22	1	μF

(\*4): Use the external synchronization frequency in the range below x2 of internal oscillating frequency  
(Maximum: 1.5 MHz).

# NJW4162A

## ■ ELECTRICAL CHARACTERISTICS

(Unless otherwise noted,  $V^+ = V_{EN} = 12V$ ,  $R_T = 10k\Omega$ , Common to CH1 and CH2,  $T_a = 25^\circ C$ )

PARAMETER	SYMBOL	TEST CONDITION	MIN.	TYP.	MAX.	UNIT
<b>Under Voltage Lockout Block</b>						
ON Threshold Voltage	$V_{T\_ON}$	$V^+ = L \rightarrow H$	4.00	4.15	4.30	V
OFF Threshold Voltage	$V_{T\_OFF}$	$V^+ = H \rightarrow L$	3.85	4.00	4.15	V
Hysteresis Voltage	$V_{HYS}$		100	150	–	mV
<b>Soft Start Block</b>						
Charge Current	$I_{CHG}$		6	8	10	$\mu A$
<b>Oscillator Block</b>						
Oscillating Frequency	$f_{OSC}$	$V_{IN-} = 0.75V, V_{FB} = 0.7V$	450	500	550	kHz
Oscillating Frequency OCP operates	$f_{OSC\_LIM}$	$V_{IN-} = 0.55V, V_{FB} = 0.7V$	–	125	–	kHz
<b>Error Amplifier Block</b>						
Reference Voltage	$V_B$		-1.0%	0.8	+1.0%	V
Input Bias Current	$I_B$		-0.1	–	0.1	$\mu A$
Output Source Current	$I_{OM+}$	$V_{FB} = 0V, V_{IN-} = 0.75V$	16	32	48	$\mu A$
Output Sink Current	$I_{OM-}$	$V_{FB} = 1V, V_{IN-} = 0.9V$	1	2	4	mA
<b>PWM Compare Block</b>						
Maximum Duty Cycle	$M_{AXDUTY}$	$V_{IN-} = 0.75V$	100	–	–	%
<b>Output Block</b>						
Output High Level ON Resistance	$R_{OH}$	$I_O = -50mA$	–	2	4	$\Omega$
Output Low Level ON Resistance	$R_{OL}$	$I_O = +50mA$	–	2	4	$\Omega$
HSREG Output Current	$I_{O\_HSREG}$	HSREG pin = $V^+ - 8V$	100	150	–	mA
Output pin Limiting Voltage	$V_{OLIM}$		$V^+ - 11$	$V^+ - 10$	$V^+ - 9$	V
<b>Enable Control Block</b>						
ON Control Voltage	$V_{ON}$	$V_{EN} = L \rightarrow H$	1.9	–	$V^+$	V
OFF Control Voltage	$V_{OFF}$	$V_{EN} = H \rightarrow L$	0	–	0.5	V
Pull-down Resistance	$R_{PD\_ON/OFF}$	$I_{EN} = 5\mu A$	–	500	–	$k\Omega$
<b>Current Limit Detection Block</b>						
Current Limit Detection Voltage	$V_{IPK}$		139	150	161	mV
Delay Time	$t_{DELAY}$		–	100	–	ns

## ■ ELECTRICAL CHARACTERISTICS

(Unless otherwise noted,  $V^+=V_{EN}=12V$ ,  $R_T=10k\Omega$ , Common to CH1 and CH2,  $T_a=25^\circ C$ )

PARAMETER	SYMBOL	TEST CONDITION	MIN.	TYP.	MAX.	UNIT
<b>Power Good Block</b>						
High Level Detection Voltage	$V_{THH\ PG}$		107	110	115	%
Low Level Detection Voltage	$V_{THL\ PG}$		85	90	93	%
Hysteresis Region	$V_{HYS\ PG}$		–	2	–	%
Power Good ON Resistance	$R_{ON\ PG}$	$I_{PG}=10mA$	–	100	–	$\Omega$
Leak Current at OFF State	$I_{LEAK\ PG}$	$V_{PG}=6V$	–	–	0.1	$\mu A$

### External Synchronization Block

High Threshold Voltage	$V_{THH\ SYNC}$		1.6	–	5.5	V
Low Threshold Voltage	$V_{THL\ SYNC}$		0	–	0.5	V
Pull-down Resistance	$R_{PD\ SYNC}$		–	500	–	$k\Omega$

### General Characteristics

Quiescent Current	$I_{DD}$	$R_L=no\ load, V_{IN-}=0.75V, V_{FB}=0.7V$	–	4	6	mA
Standby Current	$I_{DD\ STB}$	$V_{EN1,2}=0V$	–	–	10	$\mu A$

## ■ THERMAL CHARACTERISTICS

PARAMETER	SYMBOL	VALUE	UNIT
Junction-to-ambient thermal resistance	$\theta_{ja}$	125 (*4)	$^\circ C/W$
		83 (*5)	
Junction-to-Top of package characterization parameter	$\psi_{jt}$	13 (*4)	$^\circ C/W$
		9 (*5)	

(\*4): Mounted on glass epoxy board. (76.2×114.3×1.6mm:based on EIA/JDEC standard, 2Layers)

(\*5): Mounted on glass epoxy board. (76.2×114.3×1.6mm:based on EIA/JDEC standard, 4Layers),

internal Cu area: 74.2×74.2mm

## ■ POWER DISSIPATION vs. AMBIENT TEMPERATURE

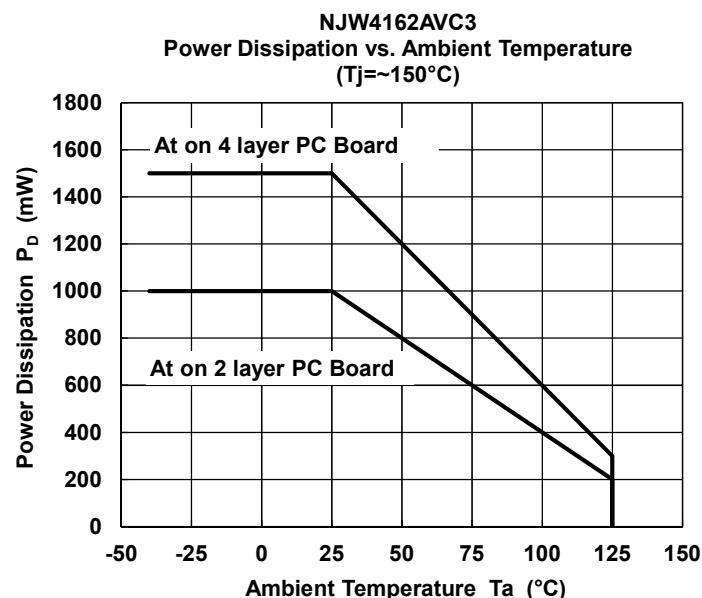

# NJW4162A

## ■ TYPICAL APPLICATIONS

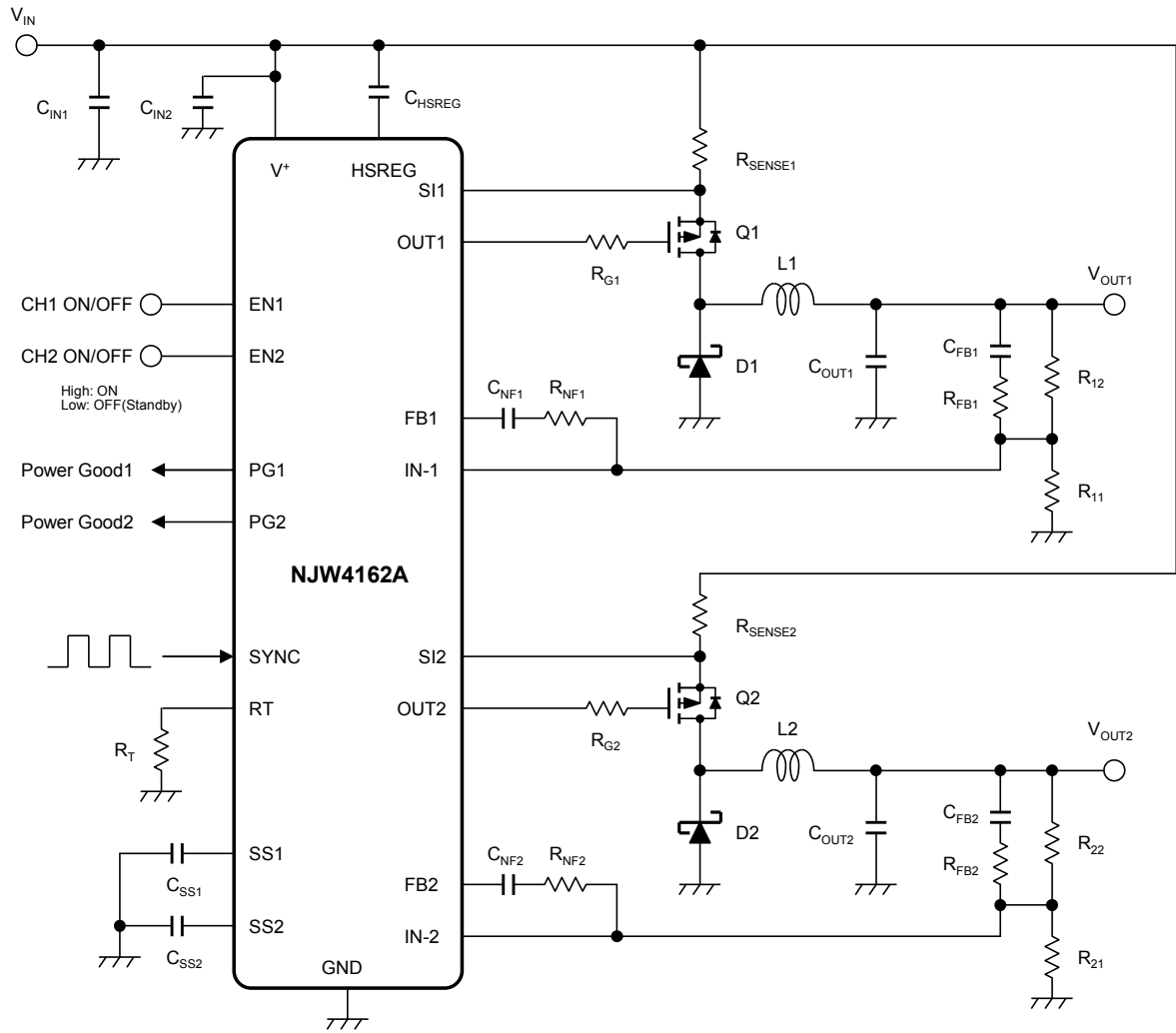



## ■ TYPICAL CHARACTERISTICS

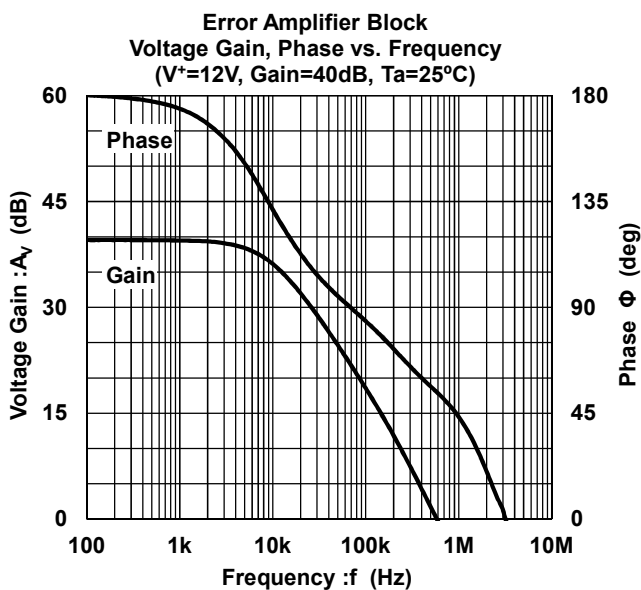
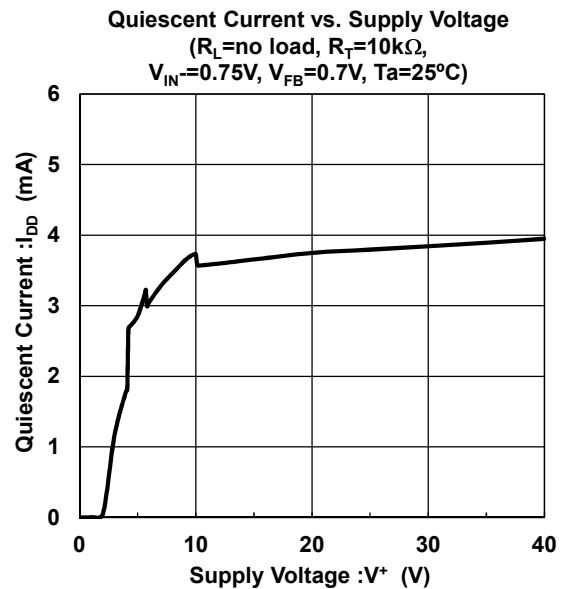
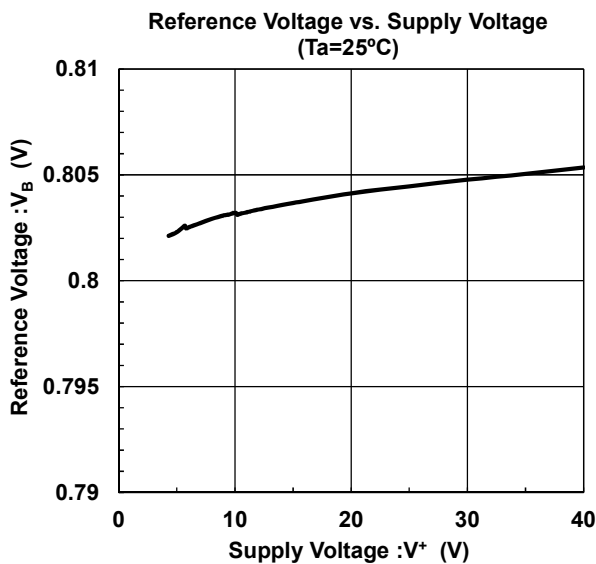
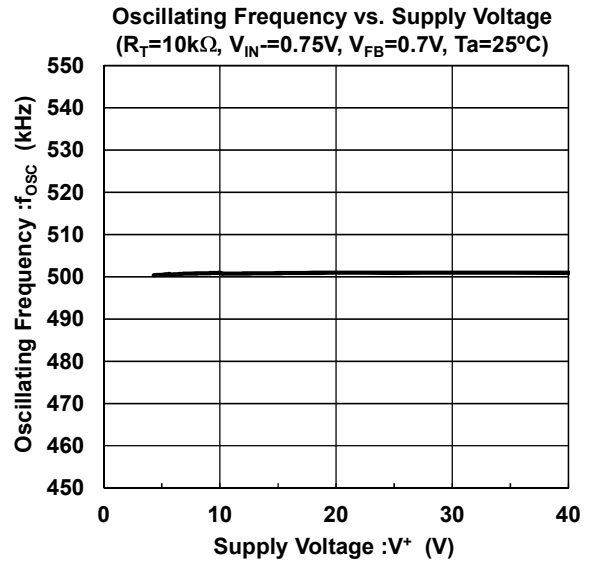
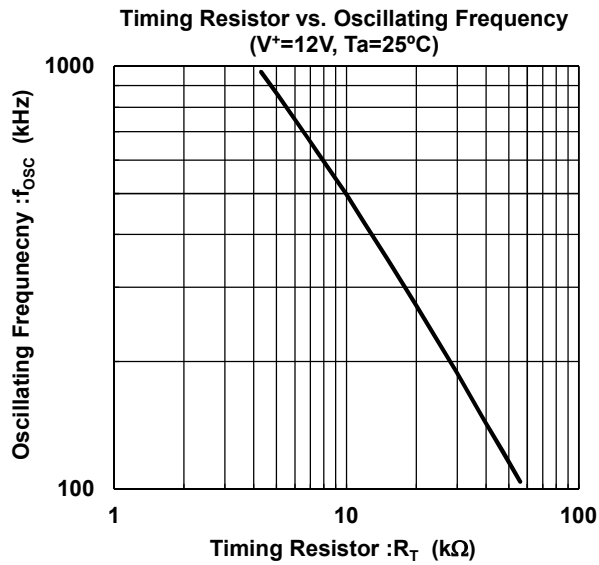

## ■ TYPICAL CHARACTERISTICS

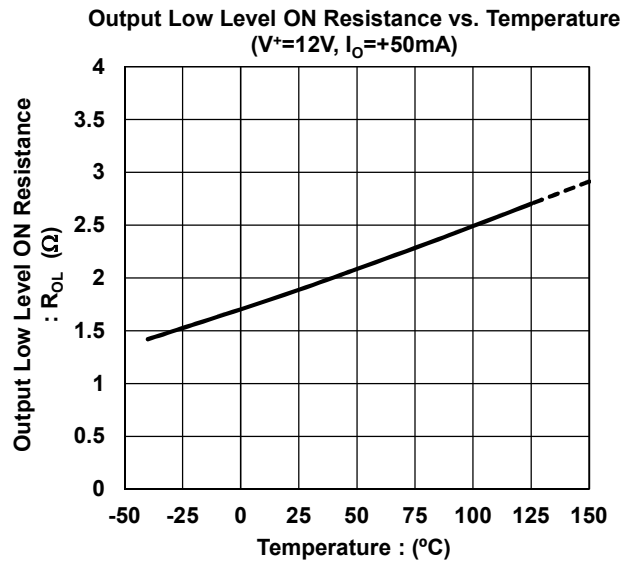
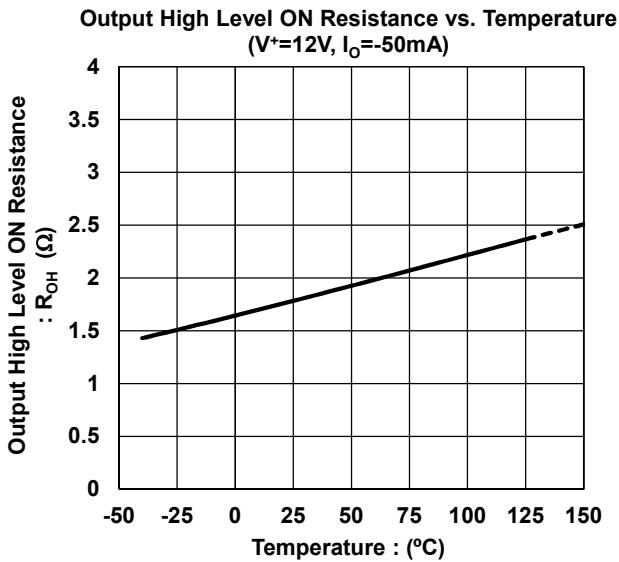
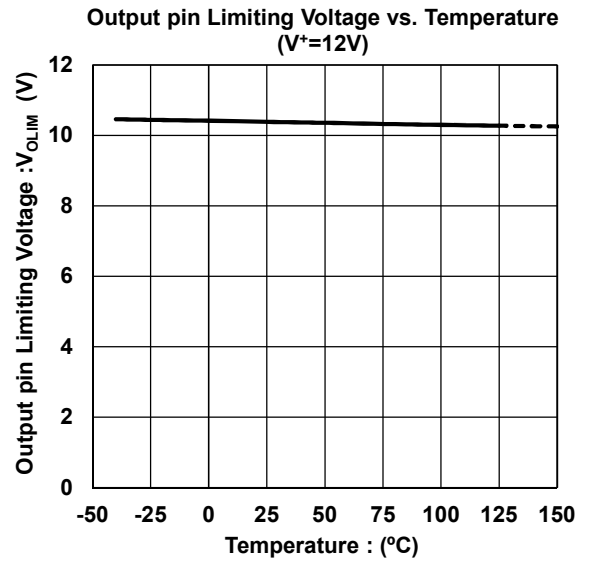
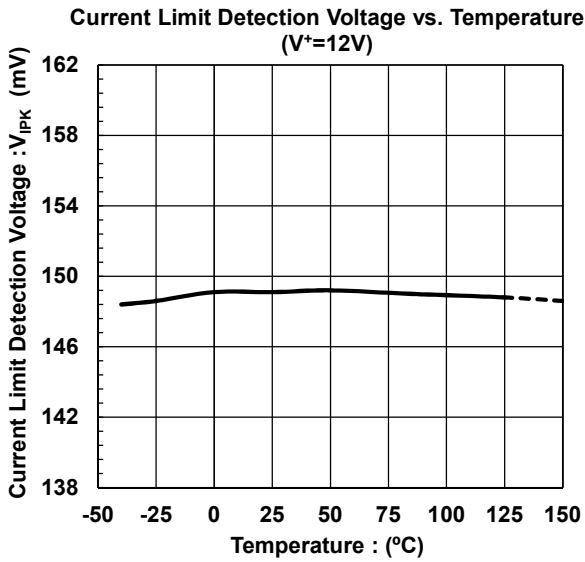
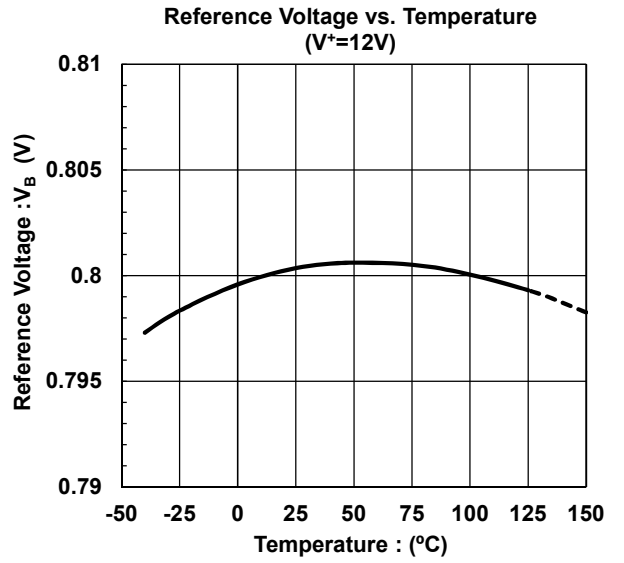
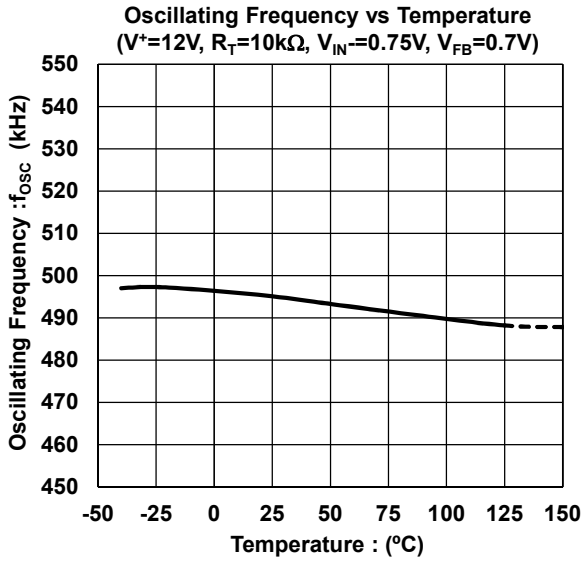

## ■ TYPICAL CHARACTERISTICS

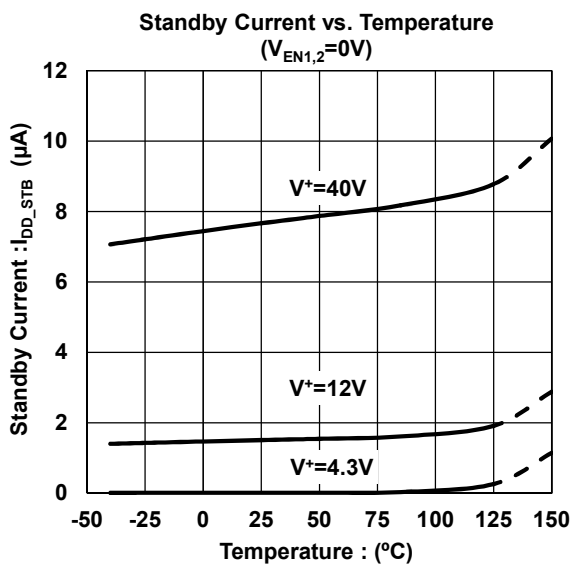
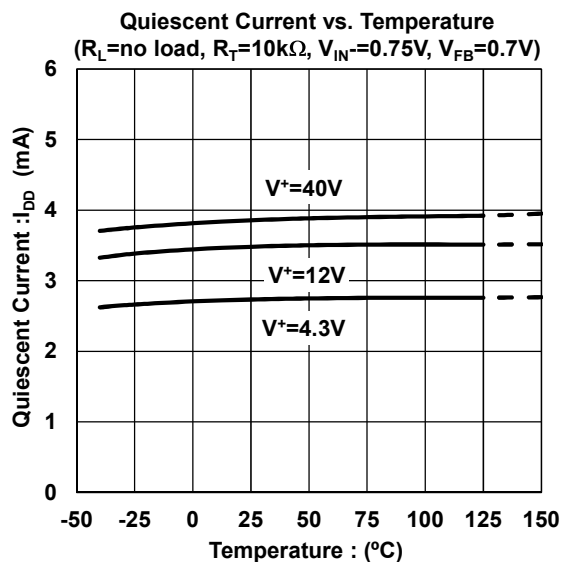
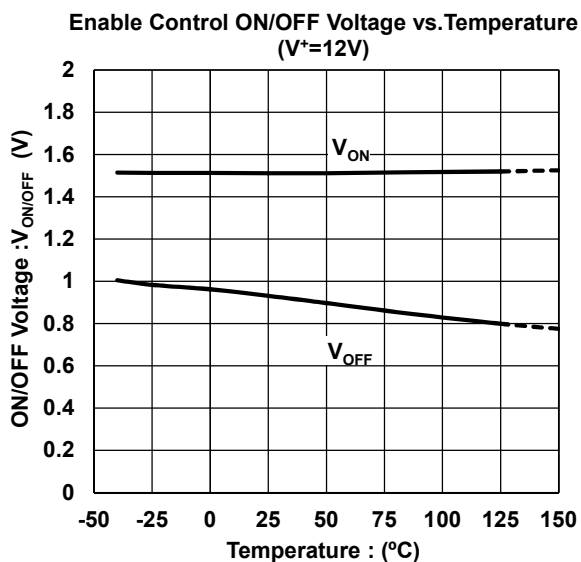
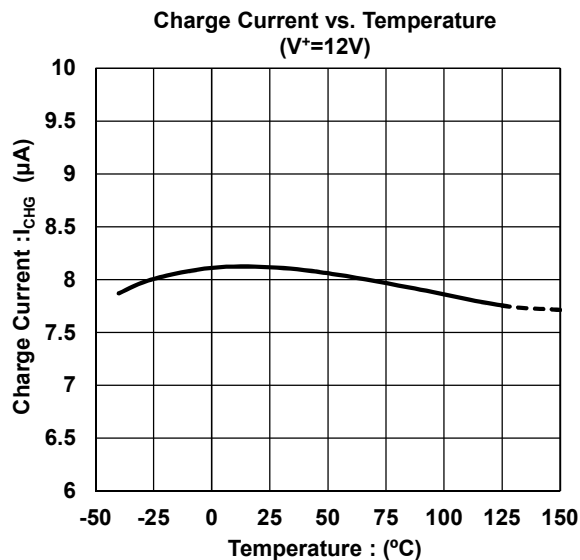
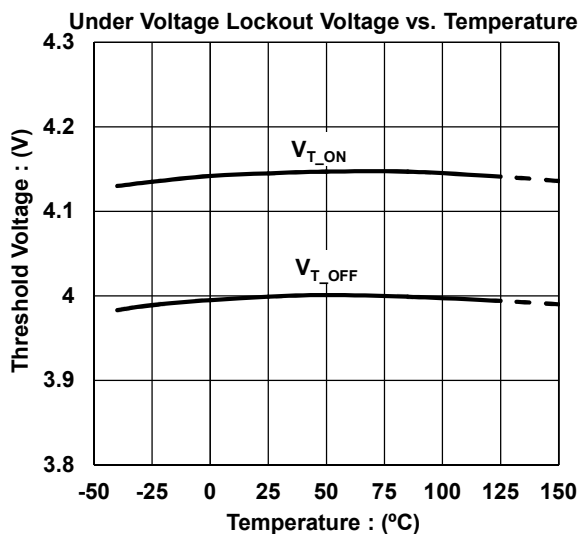

## MEMO

**[CAUTION]**

The specifications on this databook are only given for information, without any guarantee as regards either mistakes or omissions. The application circuits in this databook are described only to show representative usages of the product and not intended for the guarantee or permission of any right including the industrial rights.