

2 - phase Boost Converter Switching Regulator IC

■ GENERAL DESCRIPTION

The **NJW4141** is a 2-phase boost converter switching regulator IC that operates wide input range from 3V to 40V.

It can optimize applications by external phase compensation and voltage mode control.

The digital phase shifter adds 180 degree phase shift signal to the PWM signal and controls boost circuit by 2-phase operation. The 2-phase operation reduces an input ripple current and realizes large output current applications.

It has a pulse-by-pulse over current protection circuit that limits an output current at over load. When recovering from abnormal load condition, switching operation restarts automatically.

The **NJW4141** suitable for large output current application such as a boost power supply of audio amplifier and a boost application from battery unit.

■ PACKAGE OUTLINE

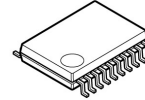

NJW4141VC3-T1

■ FEATURES

- 2-phase Boost Converter Application
- Correspond to Operating Temperature 125°C
- Nch MOSFET Driving Driving Voltage 5.1V typ.
- Wide Operating Voltage Range 3V to 40V
- PWM Control
- Wide Oscillating Frequency 50kHz to 500kHz
- Adjustable Soft Start Function
- Dead Time Control
- UVLO (Under Voltage Lockout)
- Over Current Protection
- Standby Function
- Package Outline NJW4141VC3-T1 : SSOP20-C3

Automotive NJW4141

■ PIN CONFIGURATION

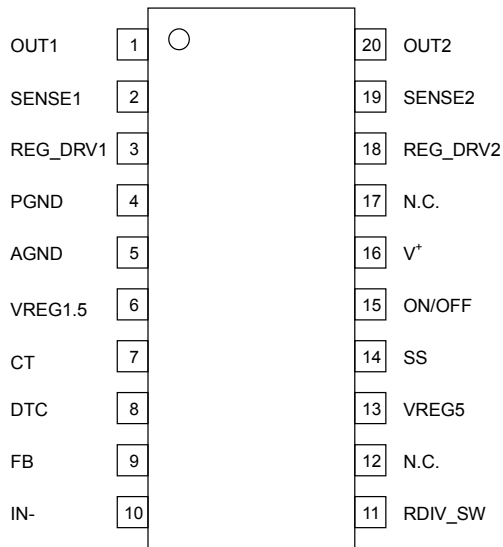

(Top View)

NJW4141VC3-T1

■ BLOCK DIAGRAM

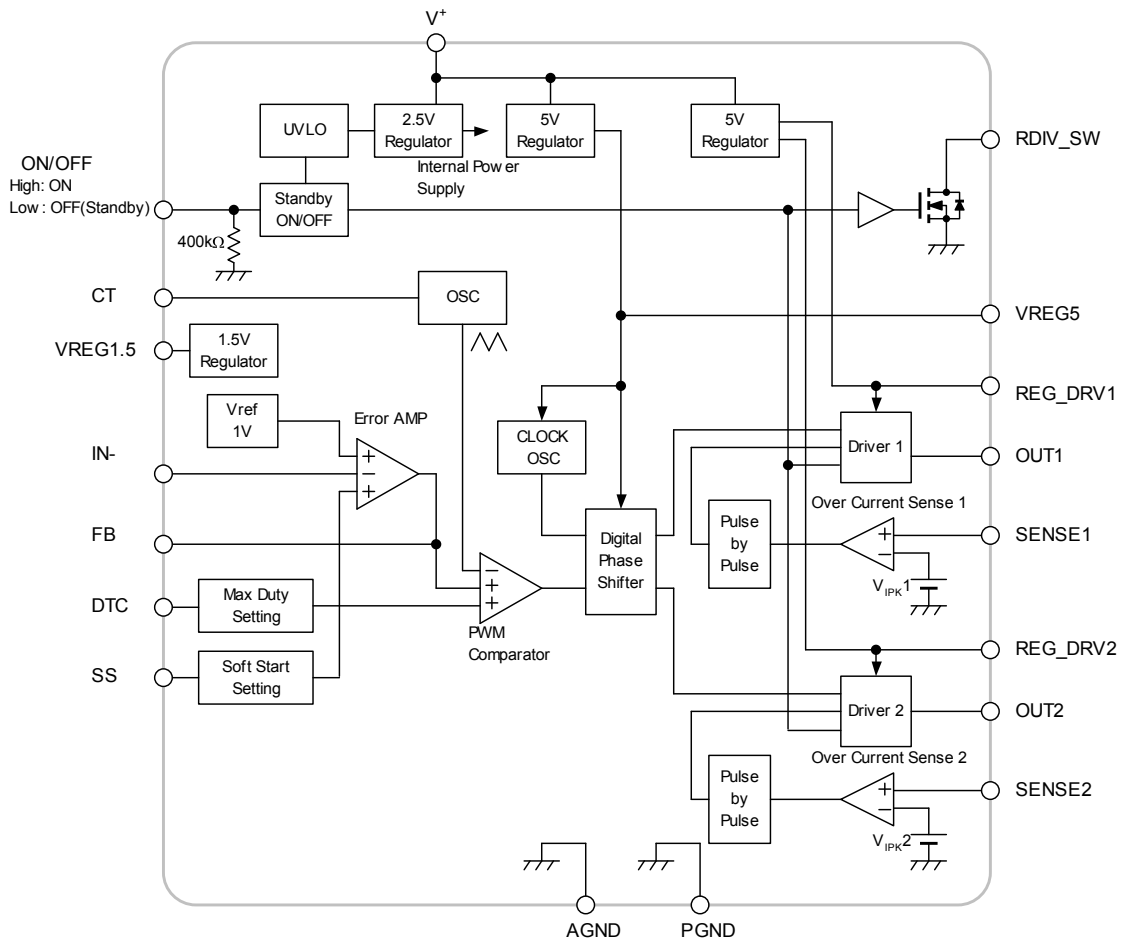

■ ABSOLUTE MAXIMUM RATINGS

(Ta=25°C)

PARAMETER	SYMBOL	MAXIMUM RATINGS	UNIT
Supply Voltage	V^+	+45	V
OUT pin Voltage (*1)	V_{OUT}	-0.3 to +5.95 (*2)	V
REG_DRV pin Voltage (*1)	V_{REG_DRV}	-0.3 to +5.95 (*2)	V
VREG1.5 pin Voltage	$V_{REG1.5}$	+1.8 (*2)	V
VREG5 pin Voltage	V_{REG5}	+5.7 (*2)	V
IN- pin Voltage	V_{IN-}	+2.8 (*2)	V
DTC pin Voltage	V_{DTC}	+2.8 (*2)	V
SENSE pin Voltage (*1)	V_{SENSE}	+2.8 (*2)	V
CT pin Voltage	V_{CT}	+2.8 (*2)	V
SS pin Voltage	V_{SS}	+2.8 (*2)	V
ON/OFF pin Voltage	$V_{ON/OFF}$	+45	V
RDIV_SW pin Voltage	V_{RDIV_SW}	+45	V
OUT pin Peak Current (1*)	I_{O_PEAK+} I_{O_PEAK-}	1,000 (Source) 900 (Sink)	mA
Power Dissipation	P_D	1,000 (*3) 1,500 (*4)	mW
Operating Temperature Range	T_{opr}	-40 to +125	°C
Storage Temperature Range	T_{stg}	-40 to +150	°C

(*1): Common to each channel.

(*2): When Supply voltage is less than each absolute maximum voltage, the absolute maximum voltage is equal to the Supply voltage.

(*3): Mounted on glass epoxy board. (76.2×114.3×1.6mm:based on EIA/JDEC standard, 2Layers)

(*4): Mounted on glass epoxy board. (76.2×114.3×1.6mm:based on EIA/JDEC standard, 4Layers),

internal Cu area: 74.2×74.2mm

■ RECOMMENDED OPERATING CONDITIONS (Ta= -40°C to +125°C)

PARAMETER	SYMBOL	MIN.	TYP.	MAX.	UNIT
Supply Voltage	V^+	3	—	40	V
Timing Capacitor	C_T	270	—	3,300	pF
Oscillating Frequency	f_{OSC}	50	—	500	kHz

Automotive NJW4141

■ ELECTRICAL CHARACTERISTICS (Unless otherwise noted, $V^+=V_{ON/OFF}=12V$, $C_T=470pF$, $T_a=25^\circ C$)

PARAMETER	SYMBOL	TEST CONDITION	MIN.	TYP.	MAX.	UNIT
Under Voltage Lockout Block						
ON Threshold Voltage	V_{T_ON}	$V^+=L \rightarrow H$	2.65	2.8	2.95	V
		$V^+=L \rightarrow H$, $T_a = -40^\circ C$ to $+125^\circ C$	2.65	-	2.95	
OFF Threshold Voltage	V_{T_OFF}	$V^+=H \rightarrow L$	2.4	2.55	2.7	V
		$V^+=H \rightarrow L$, $T_a = -40^\circ C$ to $+125^\circ C$	2.35	-	2.8	
Oscillator Block						
Oscillating Frequency1	f_{OSC1}	$C_T=470pF$	270	300	330	kHz
		$C_T=470pF$, $T_a = -40^\circ C$ to $+125^\circ C$	260	-	330	
Oscillating Frequency2	f_{OSC2}	$C_T=1,500pF$	90	100	110	kHz
		$C_T=1,500pF$, $T_a = -40^\circ C$ to $+125^\circ C$	80	-	120	
Charge Current	I_{chg}		150	200	250	μA
		$T_a = -40^\circ C$ to $+125^\circ C$	140	-	260	
Discharge Current	I_{dis}		150	200	250	μA
		$T_a = -40^\circ C$ to $+125^\circ C$	140	-	260	
Voltage amplitude	V_{OSC}		-	0.7	-	V
Oscillating Frequency deviation (Supply voltage)	f_{DV}	$V^+=3V$ to $40V$	-	3	-	%
Soft Start Block						
Charge Current (SS pin)	I_{chg_SS}		1.6	2	2.4	μA
		$T_a = -40^\circ C$ to $+125^\circ C$	1.6	-	2.4	
Threshold Voltage (SS pin)	V_{THSS0}	Duty1,2=0%	0.41	0.49	0.57	V
		Duty1,2=0%, $T_a = -40^\circ C$ to $+125^\circ C$	0.39	-	0.59	
Threshold Voltage (SS pin)	V_{THSS85}	Duty1,2=80%	0.92	1.1	1.28	V
		Duty1,2=80%, $T_a = -40^\circ C$ to $+125^\circ C$	0.87	-	1.33	
Error Amplifier Block						
Reference Voltage	V_B		-1.0%	1.00	+1.0%	V
		$T_a = -40^\circ C$ to $+125^\circ C$	-2.0%	-	+2.0%	
Input Bias Current	I_B		-0.1	-	0.1	μA
		$T_a = -40^\circ C$ to $+125^\circ C$	-0.1	-	0.1	
Open Loop Gain	A_V		-	80	-	dB
Gain Bandwidth	G_B		-	1.5	-	MHz
Output Source Current	I_{OM+}	$V_{FB}=1V$, $V_{IN}=0.9V$	40	90	140	μA
		$V_{FB}=1V$, $V_{IN}=0.9V$, $T_a = -40^\circ C$ to $+125^\circ C$	40	-	140	
Output Sink Current	I_{OM-}	$V_{FB}=1V$, $V_{IN}=1.1V$	2	4	6	mA
		$V_{FB}=1V$, $V_{IN}=1.1V$, $T_a = -40^\circ C$ to $+125^\circ C$	2	-	8	

Automotive NJW4141

■ ELECTRICAL CHARACTERISTICS

(Unless otherwise noted, $V^+ = V_{ON/OFF} = 12V$, $C_T = 470pF$, $T_a = 25^\circ C$)

PARAMETER	SYMBOL	TEST CONDITION	MIN.	TYP.	MAX.	UNIT
-----------	--------	----------------	------	------	------	------

PWM Compare Block

Maximum Duty Cycle	$M_{AX}D_{UTY90}$	Duty1,2, $V_{FB} = 1.2V$, $R_{DTC} = 100k\Omega$	80	90	95	%
		Duty1,2, $V_{FB} = 1.2V$, $R_{DTC} = 100k\Omega$, $T_a = -40^\circ C$ to $+125^\circ C$	80	-	95	
	$M_{AX}D_{UTY50}$	Duty1,2, $V_{FB} = 1.2V$, $V_{DTC} = 0.715V$	40	50	60	%
		Duty1,2, $V_{FB} = 1.2V$, $V_{DTC} = 0.715V$, $T_a = -40^\circ C$ to $+125^\circ C$	40	-	60	
	$M_{AX}D_{UTY0}$	Duty1,2, $V_{FB} = 1.2V$, $V_{DTC} = 0.3V$	-	-	0	%
		Duty1,2, $V_{FB} = 1.2V$, $V_{DTC} = 0.3V$, $T_a = -40^\circ C$ to $+125^\circ C$	-	-	0	

Phase Shift Block

Shift Time Ratio	R_{tshift}	$V_{FB} = 0.7V$, $C_T = 1,500pF$, [Definition: $t_{shift}/(t_{osc}/2)$]	-5.0%	1	+5.0%	-
		$V_{FB} = 0.7V$, $C_T = 1,500pF$, [Definition: $t_{shift}/(t_{osc}/2)$] $T_a = -40^\circ C$ to $+125^\circ C$	-7.0%	-	+7.0%	
VREG5 pin Voltage	V_{REG5}		4.8	5.1	5.4	V
		$T_a = -40^\circ C$ to $+125^\circ C$	4.7	-	5.5	

VREG Block

VREG1.5 pin Voltage	$V_{REG1.5}$	$I_{REG1.5} = 300\mu A$	-2.0%	1.5	+2.0%	V
		$I_{REG1.5} = 300\mu A$, $T_a = -40^\circ C$ to $+125^\circ C$	-4.0%	-	+4.0%	

Current Limit Detection Block (common to SENSE1 and SENSE2)

Current Limit Detection Voltage	V_{IPK}		90	110	130	mV
		$T_a = -40^\circ C$ to $+125^\circ C$	90	-	130	
Delay Time	t_{DELAY}	$\Delta V_{SENSE1} = \Delta V_{SENSE2} = 300mV$	-	190	-	ns

Output Block (common to OUT1 and OUT2)

Output High Level ON Resistance	R_{OH}	$I_{O1,2} = -50mA$	-	2.0	3.0	Ω
		$I_{O1,2} = -50mA$, $T_a = -40^\circ C$ to $+125^\circ C$	-	-	4.0	
Output Low Level ON Resistance	R_{OL}	$I_{O1,2} = +50mA$	-	3.0	4.0	Ω
		$I_{O1,2} = +50mA$, $T_a = -40^\circ C$ to $+125^\circ C$	-	-	5.0	
Output Source Current	I_{OH}	OUT1,2 pin=4.5V	45	70	105	mA
		OUT1,2 pin=4.5V, $T_a = -40^\circ C$ to $+125^\circ C$	40	-	105	
REG_DRV pin Voltage	V_{REG_DRV}		5	5.3	5.6	V
		$T_a = -40^\circ C$ to $+125^\circ C$	5	-	5.75	

Automotive NJW4141

■ ELECTRICAL CHARACTERISTICS (Unless otherwise noted, $V^+ = V_{ON/OFF} = 12V$, $C_T = 470pF$, $T_a = 25^\circ C$)

PARAMETER	SYMBOL	TEST CONDITION	MIN.	TYP.	MAX.	UNIT
Output Division Resistor Switch						
Low Level Output Voltage	V_{OL_RDIV}	$V_{ON/OFF} = 12V, I_{O_RDIV} = +0.5mA$	–	0.1	0.25	V
		$V_{ON/OFF} = 12V, I_{O_RDIV} = +0.5mA, T_a = -40^\circ C \text{ to } +125^\circ C$	–	–	0.25	
Leak Current	I_{LEAK_RDIV}	$V_{ON/OFF} = 0V, V_{O_RDIV} = 40V$	–	–	1	μA
		$V_{ON/OFF} = 0V, V_{O_RDIV} = 40V, T_a = -40^\circ C \text{ to } +125^\circ C$	–	–	1	
ON/OFF Control Block						
ON Control Voltage	V_{ON}	$V_{ON/OFF} = L \rightarrow H$	1.5	–	V^+	V
		$V_{ON/OFF} = L \rightarrow H, T_a = -40^\circ C \text{ to } +125^\circ C$	1.5	–	V^+	
OFF Control Voltage	V_{OFF}	$V_{ON/OFF} = H \rightarrow L$	0	–	0.6	V
		$V_{ON/OFF} = H \rightarrow L, T_a = -40^\circ C \text{ to } +125^\circ C$	0	–	0.6	
ON/OFF pin Pull-down Resistance	$R_{ON/OFF}$		–	400	–	$k\Omega$
General Characteristics						
Quiescent Current 1	I_{DD1}	$R_L = \text{no load}, V_{IN} = 0.7V, C_T = 470pF$	–	3.6	4.2	mA
		$R_L = \text{no load}, V_{IN} = 0.7V, C_T = 470pF, T_a = -40^\circ C \text{ to } +125^\circ C$	–	–	4.7	
Quiescent Current 2	I_{DD2}	$R_L = \text{no load}, V_{IN} = 0.7V, C_T = 1,500pF$	–	3.2	3.8	mA
		$R_L = \text{no load}, V_{IN} = 0.7V, C_T = 1,500pF, T_a = -40^\circ C \text{ to } +125^\circ C$	–	–	4.5	
Standby Current	I_{DD_STB}	$V_{ON/OFF} = 0V$	–	2.5	6	μA
		$V_{ON/OFF} = 0V, T_a = -40^\circ C \text{ to } +125^\circ C$	–	–	8	

■ THERMAL CHARACTERISTICS

PARAMETER	SYMBOL	VALUE	UNIT
Junction-to-ambient thermal resistance	θ_{ja}	125 (*5)	°C/W
		83 (*6)	
Junction-to-Top of package characterization parameter	ψ_{jt}	13 (*5) 9 (*6)	°C/W

(*5): Mounted on glass epoxy board. (76.2×114.3×1.6mm:based on EIA/JDEC standard, 2Layers)

(*6): Mounted on glass epoxy board. (76.2×114.3×1.6mm:based on EIA/JDEC standard, 4Layers),

internal Cu area: 74.2×74.2mm

■ POWER DISSIPATION vs. AMBIENT TEMPERATURE

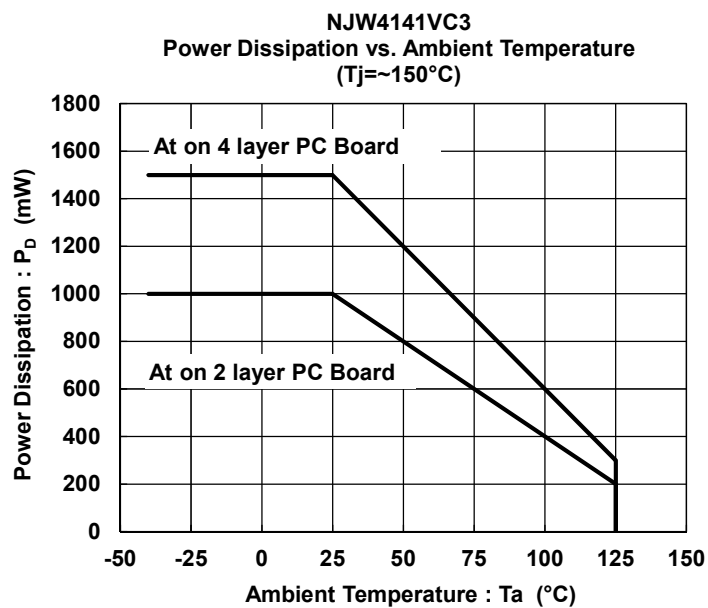

Automotive NJW4141

■ TYPICAL APPLICATIONS

2 Phase Boost Applications

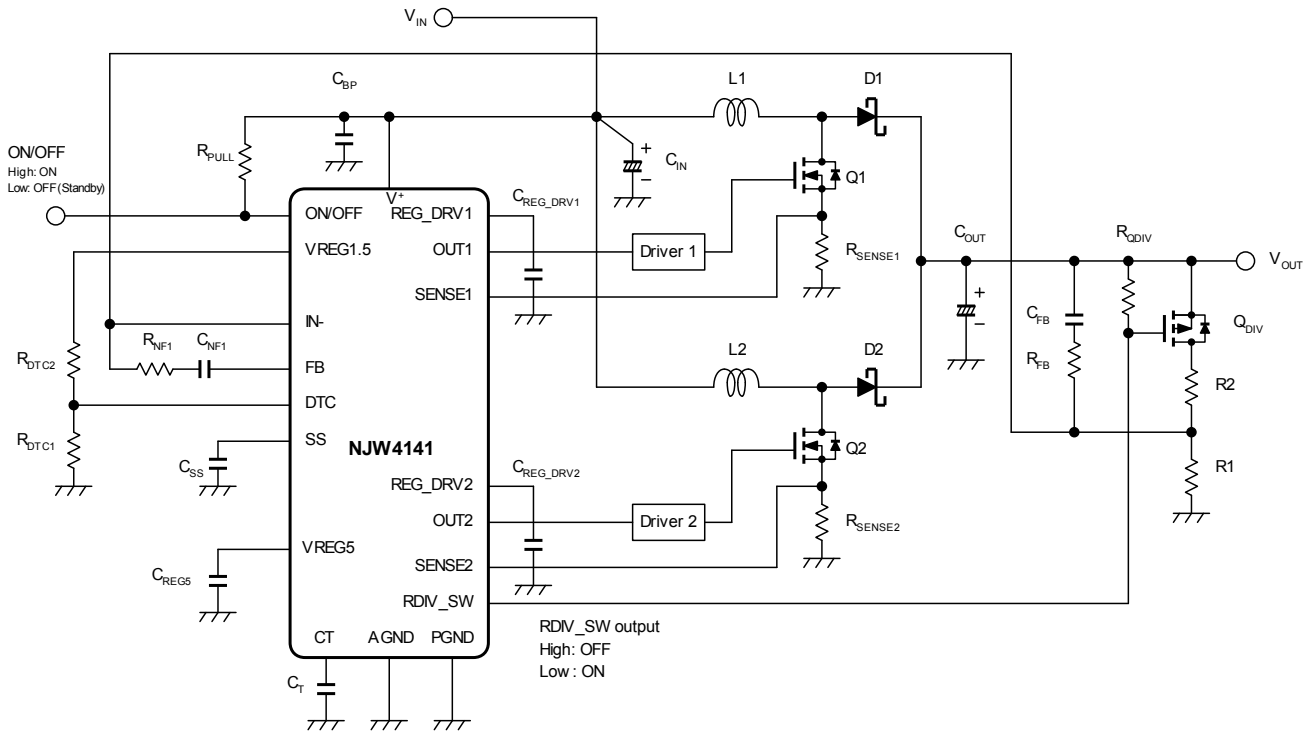

■ TYPICAL CHARACTERISTICS

Oscillating Frequency vs. Timing Capacitor
($V^+=12V$, $T_a=25^\circ C$)

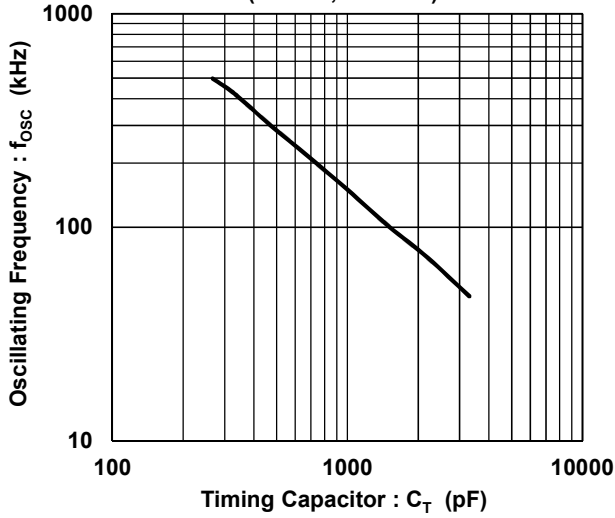

Oscillating Frequency 1 vs. Supply Voltage
($T_a=25^\circ C$)

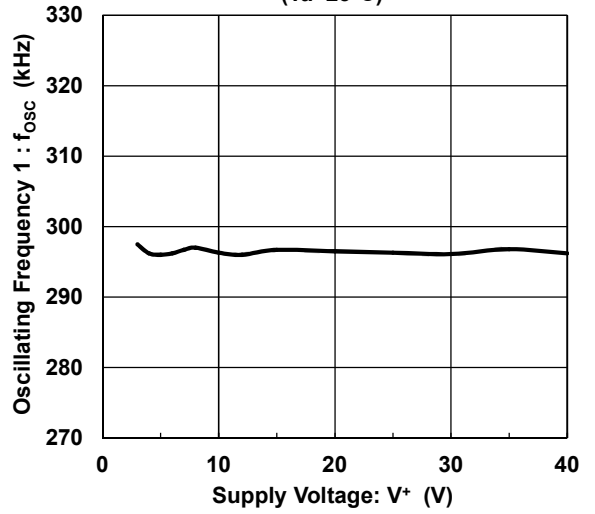

Reference Voltage vs. Supply Voltage
($T_a=25^\circ C$)

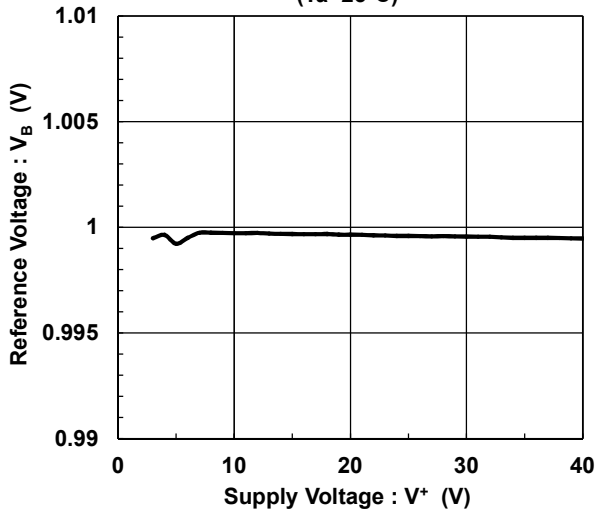

OUT pin Voltage vs. Supply Voltage
($I_o=0mA$, $T_a=25^\circ C$)

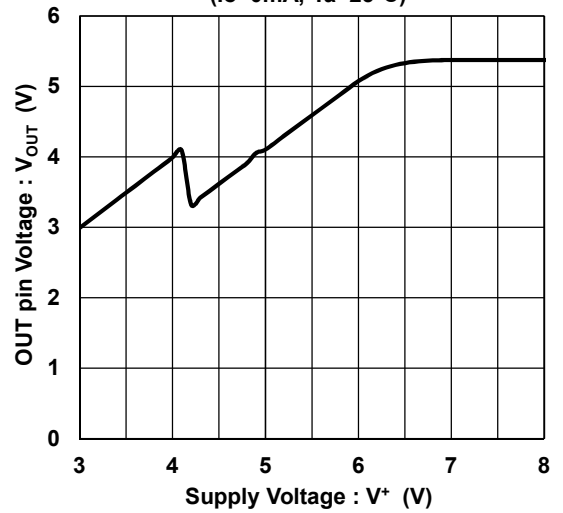

Error Amplifire Block
Voltage Gain, Phase vs. Frequency
($V^+=12V$, Gain=40dB, $T_a=25^\circ C$)

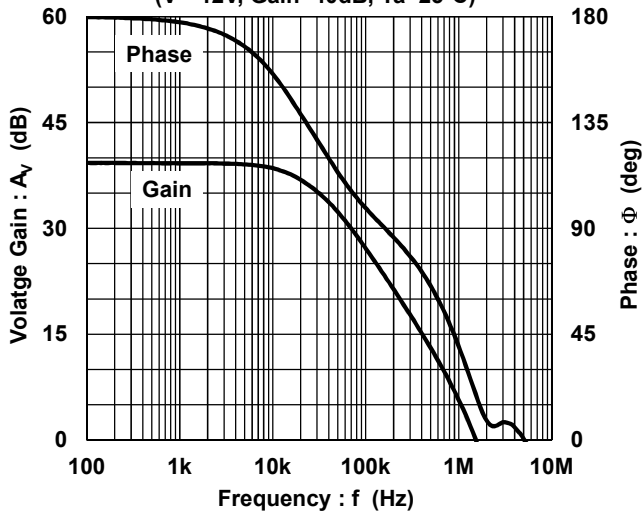

Automotive NJW4141

■ TYPICAL CHARACTERISTICS

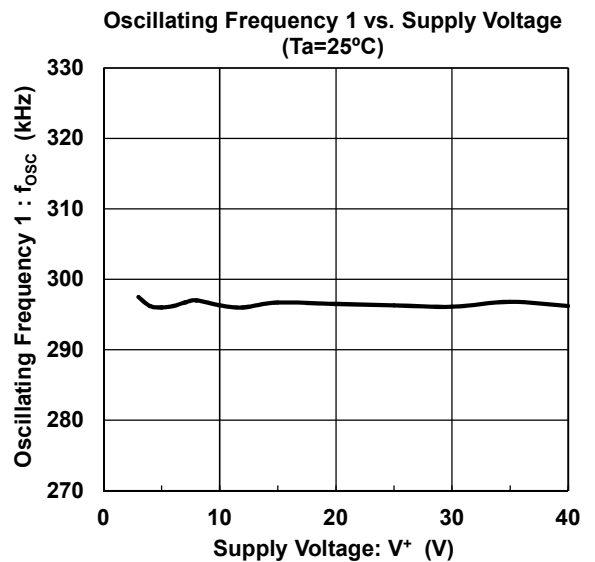
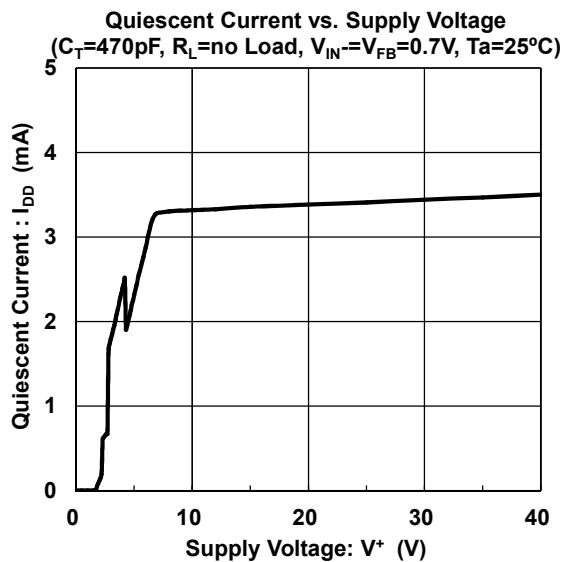
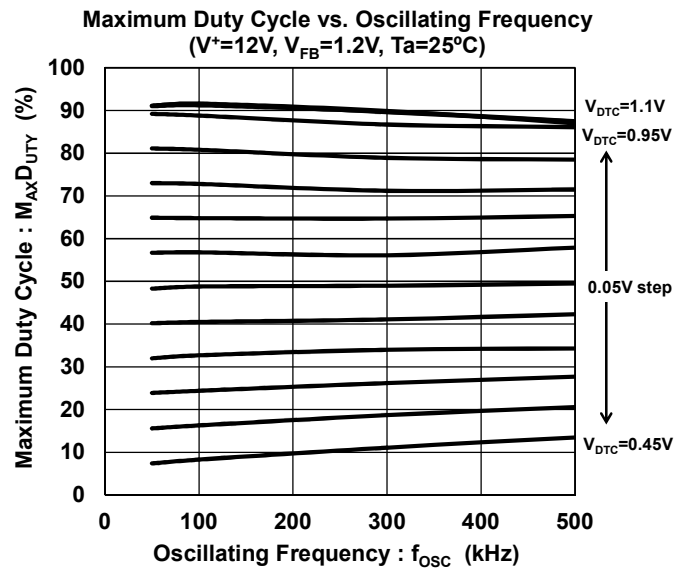
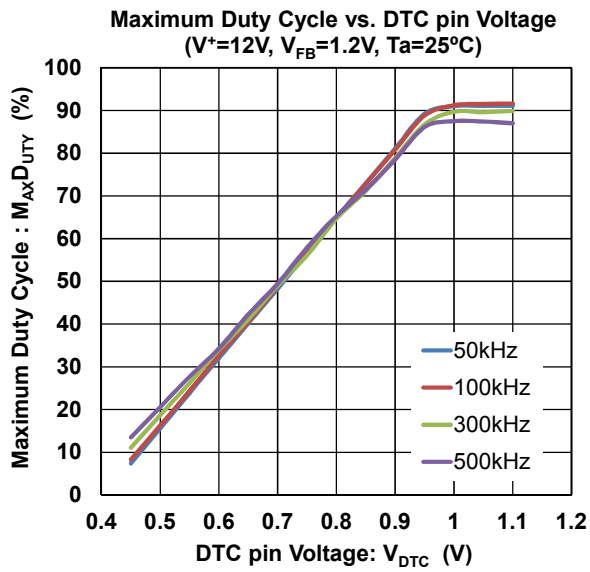

■ TYPICAL CHARACTERISTICS

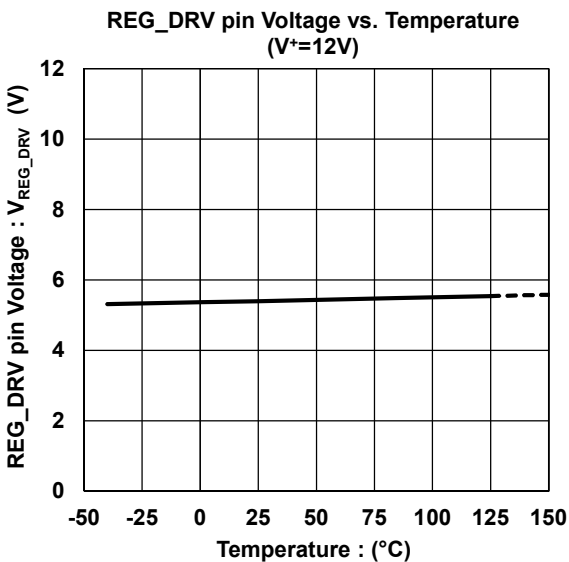
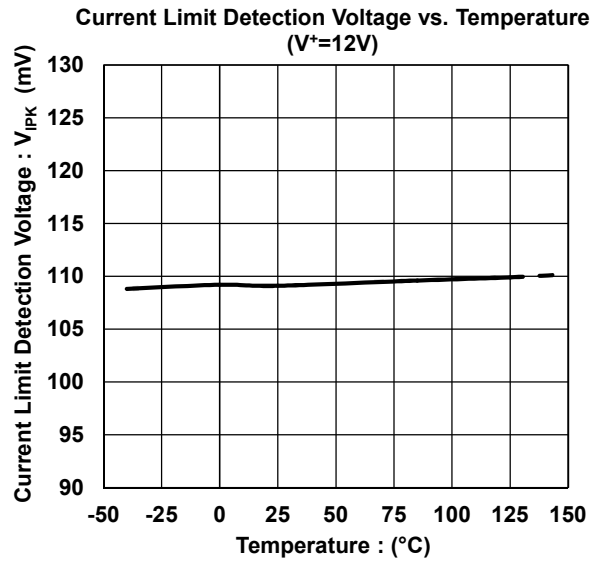
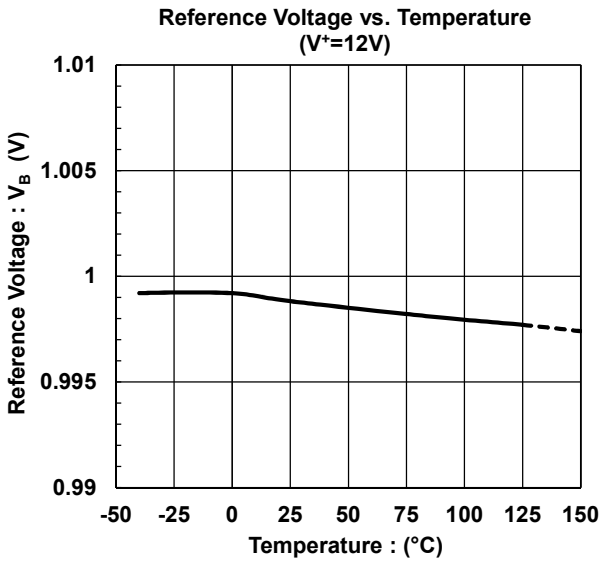
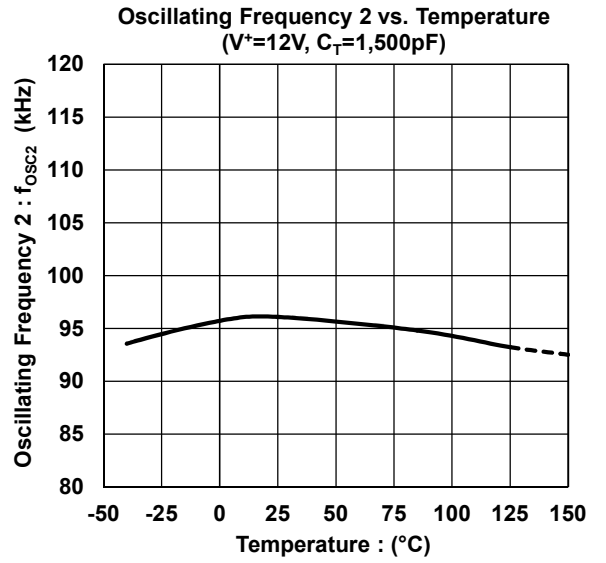
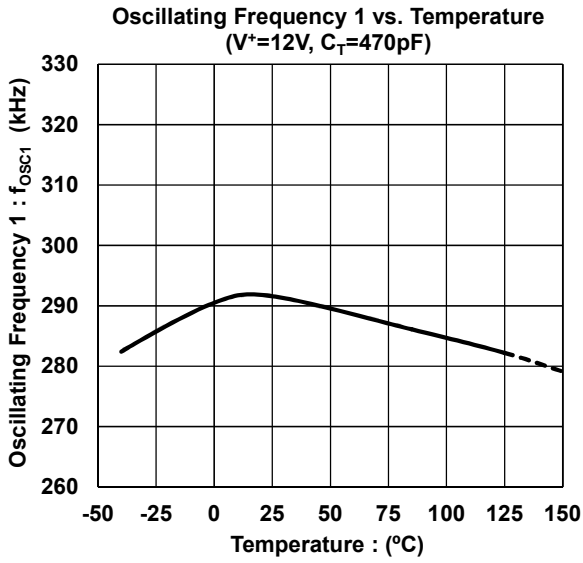

Automotive NJW4141

■ TYPICAL CHARACTERISTICS

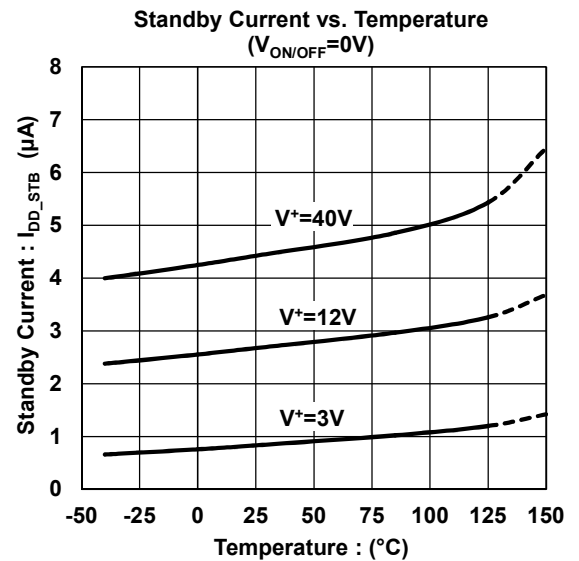
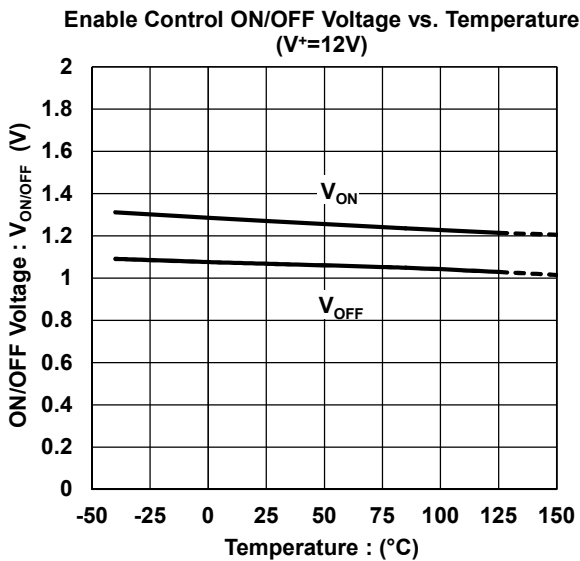
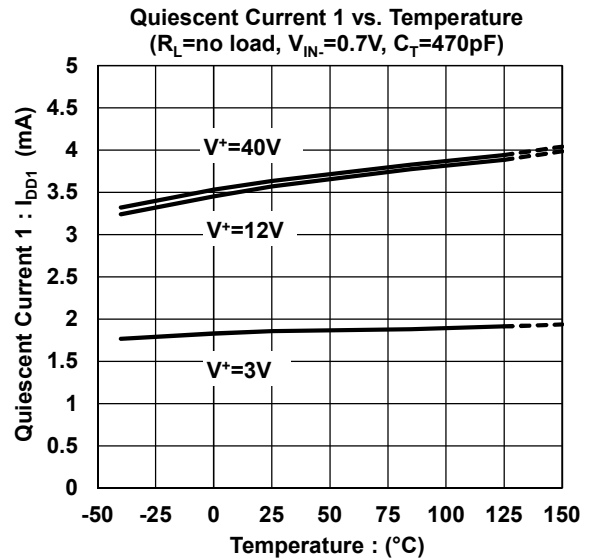
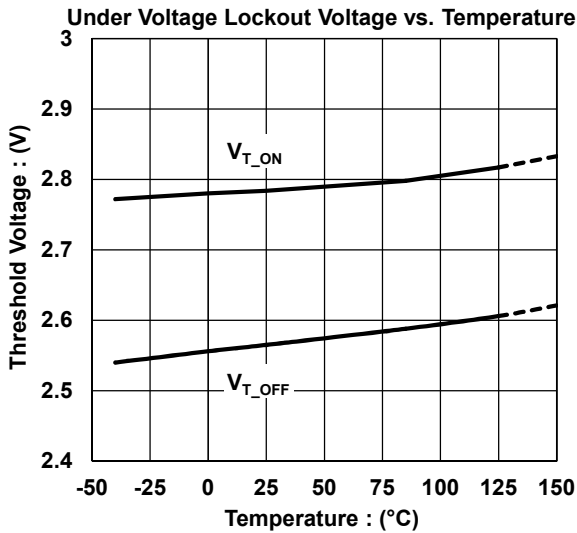
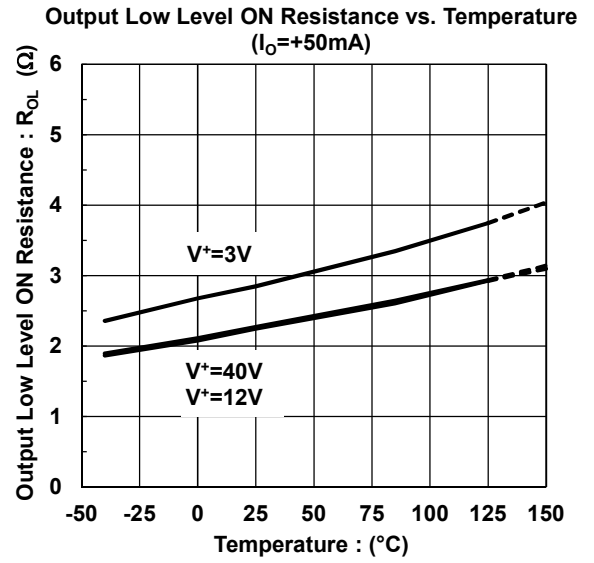
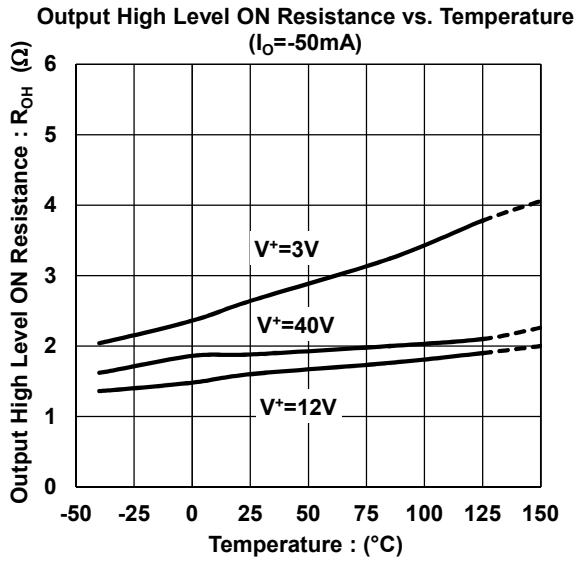

MEMO

[CAUTION]

The specifications on this databook are only given for information, without any guarantee as regards either mistakes or omissions. The application circuits in this databook are described only to show representative usages of the product and not intended for the guarantee or permission of any right including the industrial rights.