

Step-Down switching regulator IC with Constant Current Control

■ GENERAL DESCRIPTION

The **NJU7650** is a low voltage operation high-speed switching regulator control IC for step-down converter, with a constant current control. It incorporates a totem pole output, which can drive an external MOS-FET easily. It also incorporates error amplifier and current sense amplifier, which can allow the constant voltage/current control for output voltage. Therefore the NJU7650 is suitable for a LED driving, battery charger and other CCCV applications. The NJU7650 is available in a small and thin 8-lead MSOP (TVSP) package.

■ FEATURES

- PWM switching control
- Constant Current Control
- Operating Voltage 2.2V to 8V
- Wide Oscillator Range 300kHz to 1MHz
- Maximum Duty Cycle 100%
- Quiescent Current 800 μ A typ.
- Soft-Start Function Internal : 16ms typ. or adjustable
- Dead Time Control
- C-MOS Technology
- Package Outline NJU7650RB1 : MSOP8 (TVSP8)*

*MEET JEDEC MO-187-DA / THIN TYPE

■ PIN CONFIGURATION

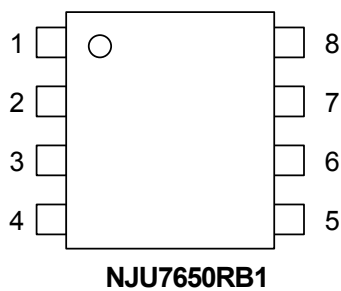

PIN FUNCTION

1. OUT
2. V⁺
3. FB
4. IN-1
5. IN-2
6. DTC
7. RT
8. GND

■ PACKAGE OUTLINE



NJU7650RB1
(MSOP8 (TVSP8))

■ PRODUCT VARIATION

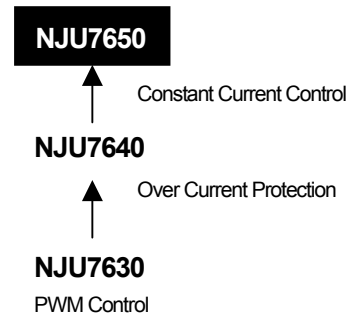

NJU7650

■ BLOCK DIAGRAM

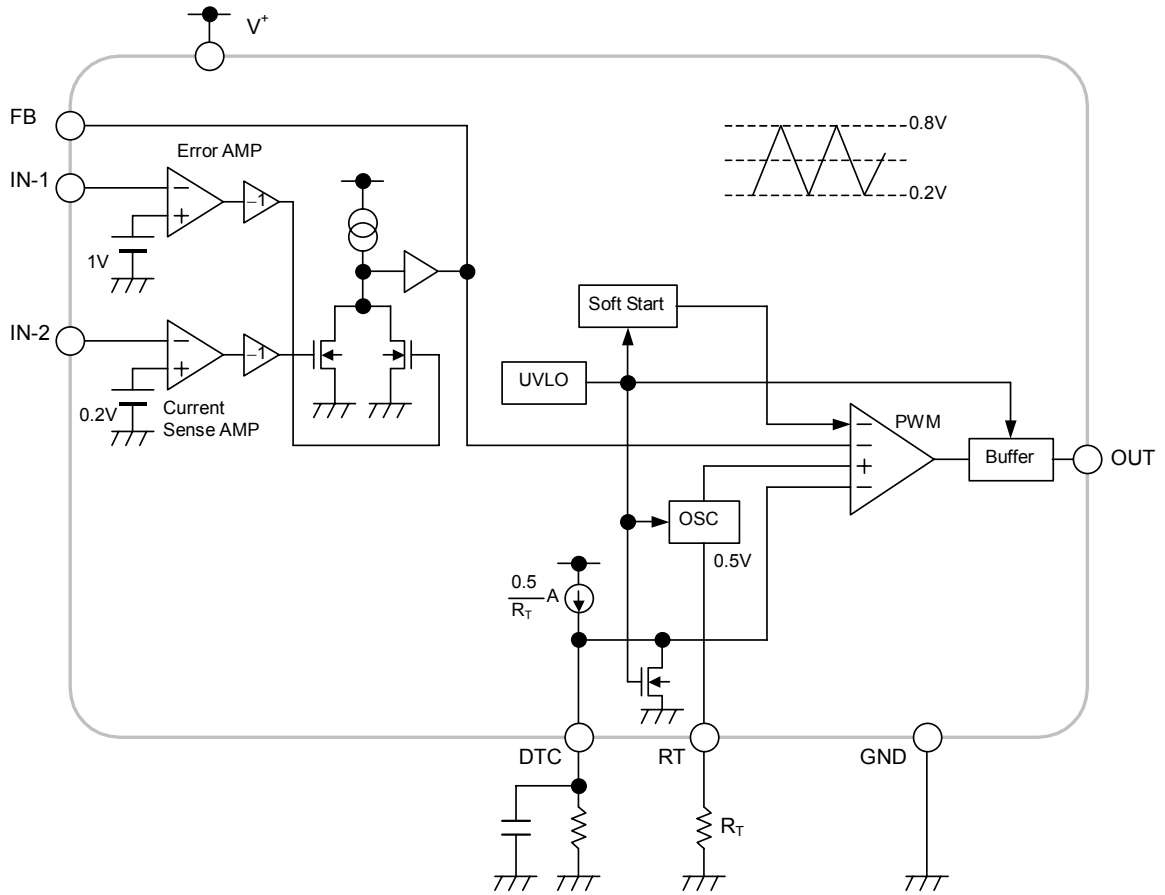

■ ABSOLUTE MAXIMUM RATINGS

(Ta=25°C)

PARAMETER	SYMBOL	MAXIMUM RATINGS	UNIT
Supply Voltage	V ⁺	+9	V
Output Pin Current	I _O	±50	mA
Power Dissipation	P _D	MSOP8 (TVSP8) :320	mW
Operating Temperature Range	T _{OPR}	-40 to +85	°C
Storage Temperature Range	T _{STG}	-40 to +125	°C

■ RECOMMENDED OPERATING CONDITIONS

(Ta=25°C)

PARAMETER	SYMBOL	MIN.	TYP.	MAX.	UNIT
Operating Voltage	V ⁺	2.2	–	8	V
Oscillator Timing Resistor	R _T	30	47	120	kΩ
Oscillation Frequency	f _{OSC}	300	700	1,000	kHz

■ ELECTRICAL CHARACTERISTICS

(V⁺=3.3V, R_T=47kΩ, Ta=25°C)

PARAMETER	SYMBOL	TEST CONDITION	MIN.	TYP.	MAX.	UNIT
Under Voltage Lockout Block						
ON Threshold Voltage	V _{T,ON}	V ⁺ = L → H	1.9	2.0	2.1	V
OFF Threshold Voltage	V _{T,OFF}	V ⁺ = H → L	1.8	1.9	2.0	V
Hysteresis Voltage	V _{HYS}		60	100	–	mV
Soft Start Block						
Soft Start Time	T _{SS}	V _{T,ON} → Duty=80%	8	16	24	ms
Oscillator Block						
RT Pin Voltage	V _{RT}		-5%	0.5	+5%	V
Oscillation Frequency	f _{OSC}		630	700	770	kHz
Oscillate Supply Voltage Fluctuations	f _{DV}	V ⁺ =2.2V to 8V	–	1	–	%
Oscillate Temperature Fluctuations	f _{DT}	Ta=-40°C to +85°C	–	3	–	%

NJU7650

■ ELECTRICAL CHARACTERISTICS

($V^+=3.3V$, $R_T=47k\Omega$, $T_a=25^\circ C$)

PARAMETER	SYMBOL	TEST CONDITION	MIN.	TYP.	MAX.	UNIT
Error Amplifier Block						
Reference Voltage 1	V_{B1}		-1.0%	1.00	+1.0%	V
Input Bias Current 1	I_{B1}		-0.1	–	0.1	μA
Open Loop Gain 1	A_{V1}		–	80	–	dB
Gain Bandwidth Product 1	G_{B1}		–	1	–	MHz
Output Source Current 1	I_{OM+1}	$V_{FB}=1V, V_{IN-1}=0.9V, V_{IN-2}=0.1V$	25	55	95	mA
	I_{OM+2}	$V_{FB}=1V, V_{IN-1}=0.9V, V_{IN-2}=0.1V, V^+=2.2V$	4	9	16	mA
Output Sink Current 1	I_{OM-}	$V_{FB}=1V, V_{IN-1}=1.1V, V_{IN-2}=0.1V$	0.10	0.16	0.22	mA
Current Sense Amplifier Block						
Reference Voltage 2	V_{B2}		-10%	0.2	+10%	V
Input Bias Current 2	I_{B2}		-0.1	–	0.1	μA
Open Loop Gain 2	A_{V2}		–	70	–	dB
Gain Bandwidth Product 2	G_{B2}		–	1	–	MHz
Output Sink Current 2	I_{OM2-}	$V_{FB}=1V, V_{IN-1}=0.9V, V_{IN-2}=0.3V$	0.10	0.16	0.22	mA
PWM Compare Block						
Input Threshold Voltage	V_{T0}	Duty=0%	0.16	0.22	0.28	V
	V_{T50}	Duty=50%	0.44	0.5	0.56	V
Maximum Duty Cycle	$M_{AXDUTY1}$	$V_{FB}=0.9V$	100	–	–	%
	$M_{AXDUTY2}$	$V_{FB}=0.9V, R_{DTC}=47k\Omega$	40	50	60	%
Output Block						
Output High Level ON Resistance	R_{OH}	$I_o=-20mA$	–	10	20	Ω
Output Low Level ON Resistance	R_{OL}	$I_o=+20mA$	–	5	10	Ω
General Characteristics						
Quiescent Current	I_{DD}	$R_L=Non\ Load$	–	800	1200	μA

■ TYPICAL CHARACTERISTICS

Oscillation Frequency vs. Timing Resistance
($V^+ = 3.3V$, $T_a = 25^\circ C$)

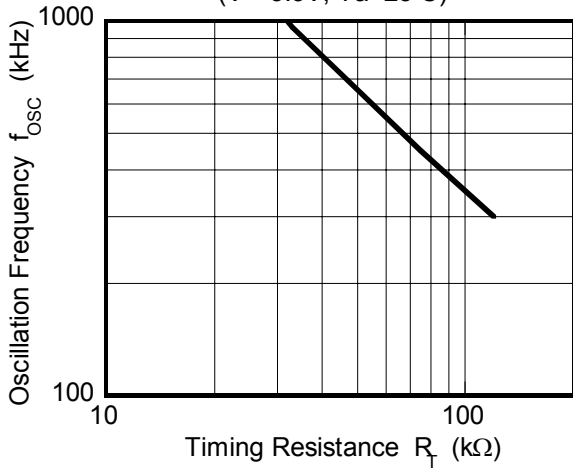

Oscillation Frequency vs. Operating Voltage
($R_T = 47k\Omega$, $T_a = 25^\circ C$)

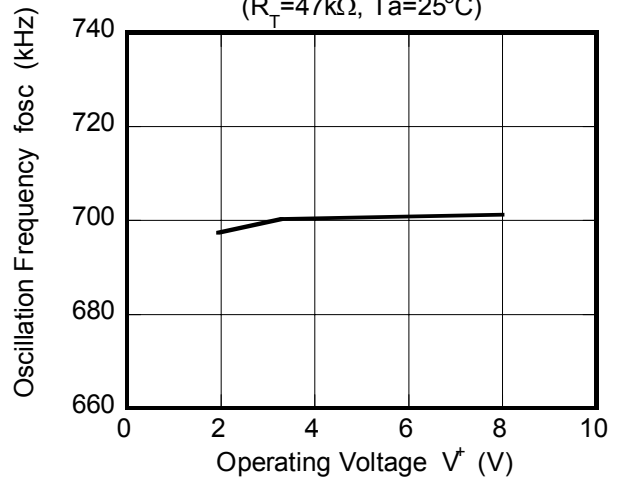

Duty Cycle vs. R_{DTC}

($V^+ = 3.3V$, $R_T = 47k\Omega$, $T_a = 25^\circ C$)

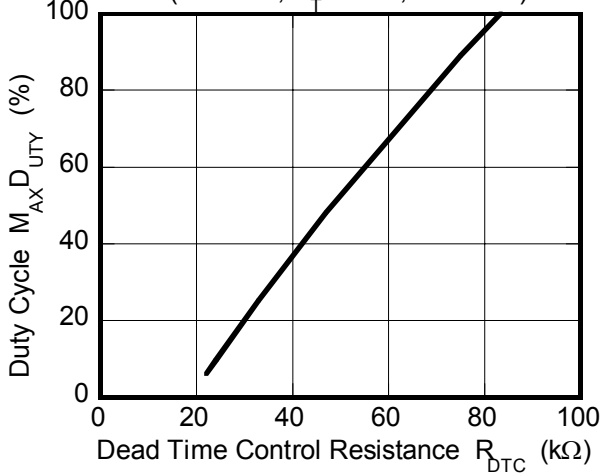

Quiescent Current vs. Operating Voltage

($R_T = 47k\Omega$, $R_L = \text{Non Load}$, $T_a = 25^\circ C$)

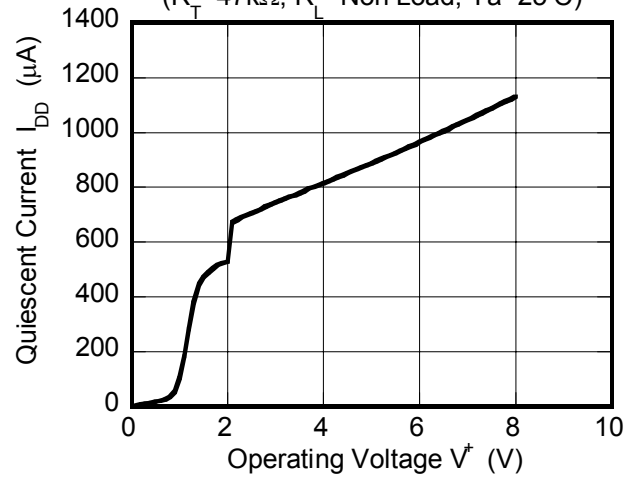

Error Amplifier Block
Reference Voltage1 vs. Operating Voltage

($T_a = 25^\circ C$)

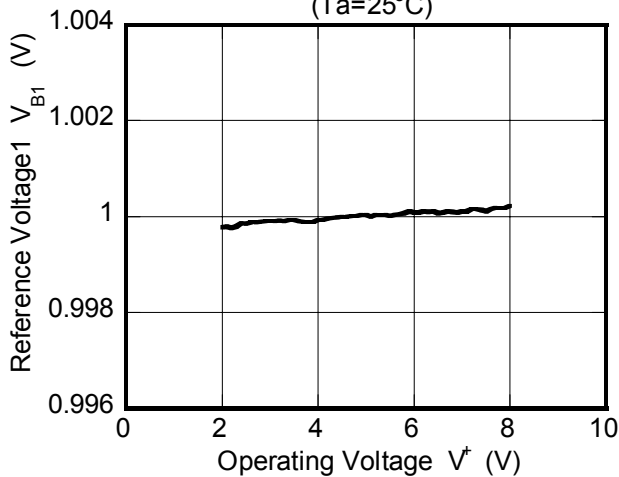

Current Sense Amplifier Block
Reference Voltage2 vs. Operating Voltage

($T_a = 25^\circ C$)

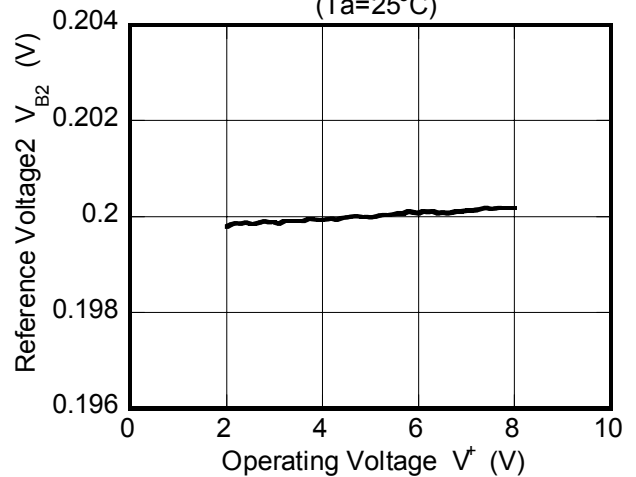

■ TYPICAL CHARACTERISTICS

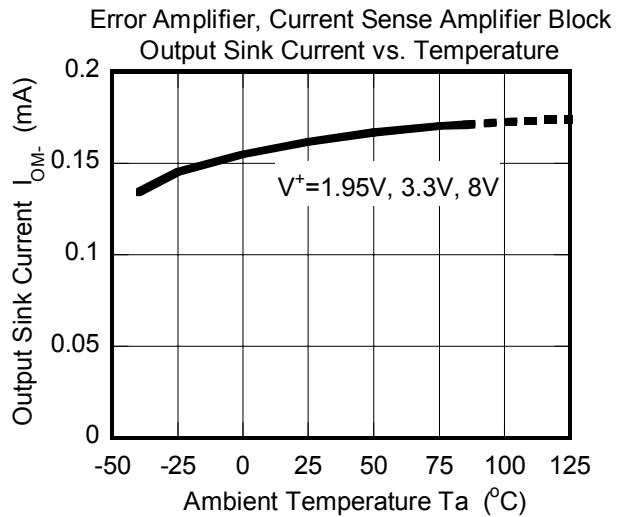
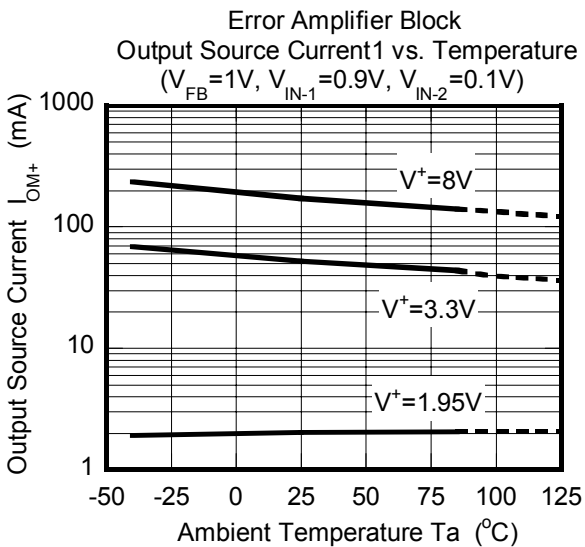
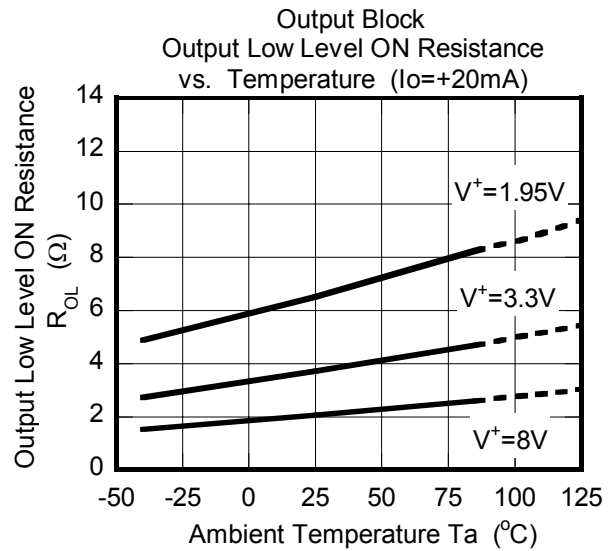
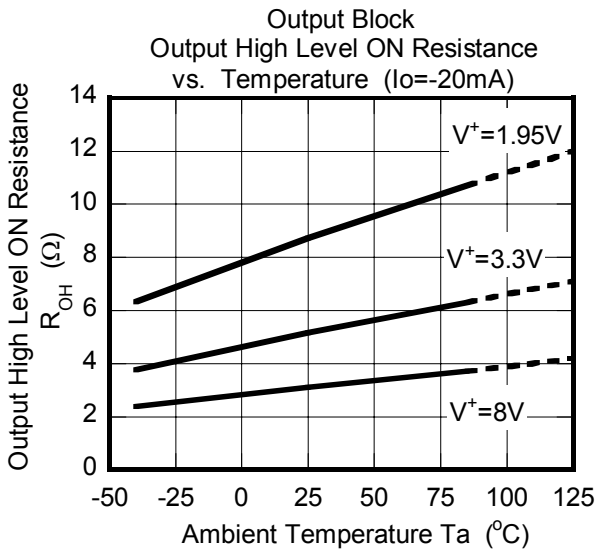
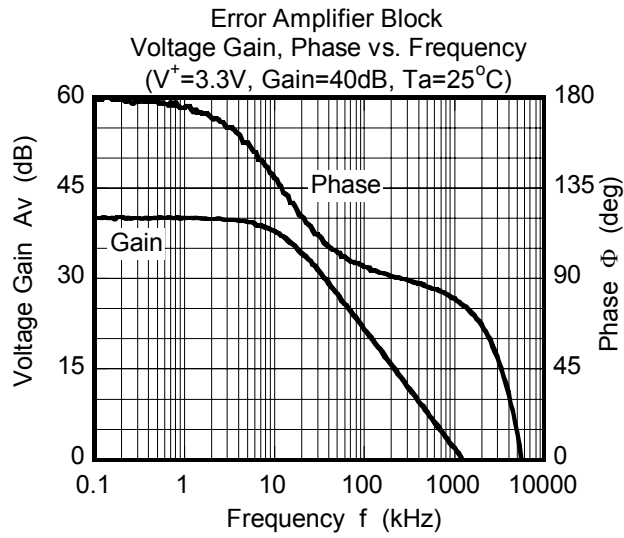

■ TYPICAL CHARACTERISTICS

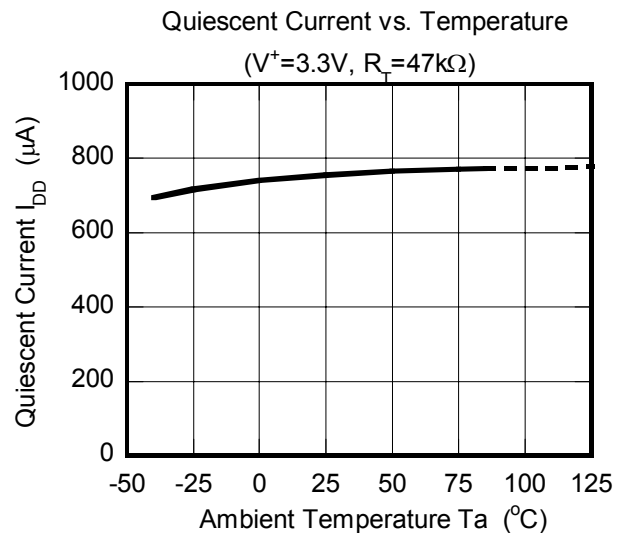
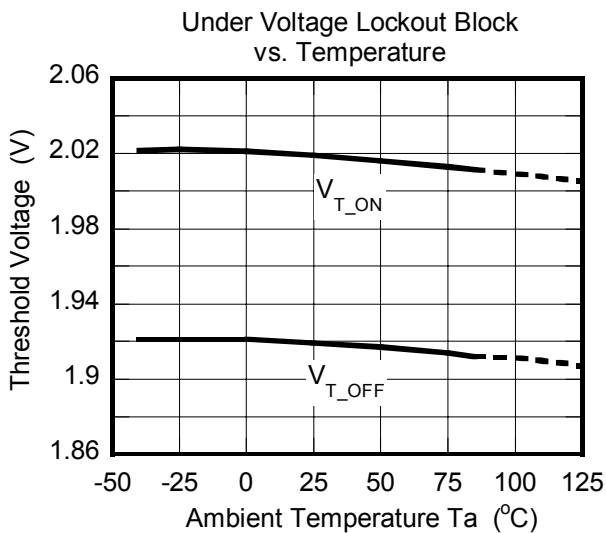
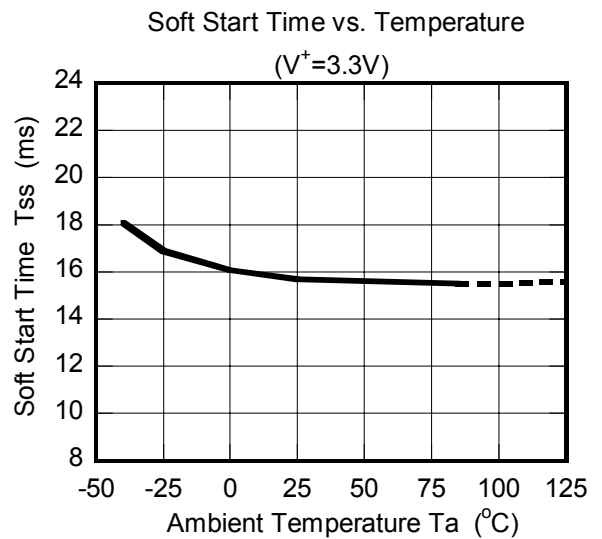
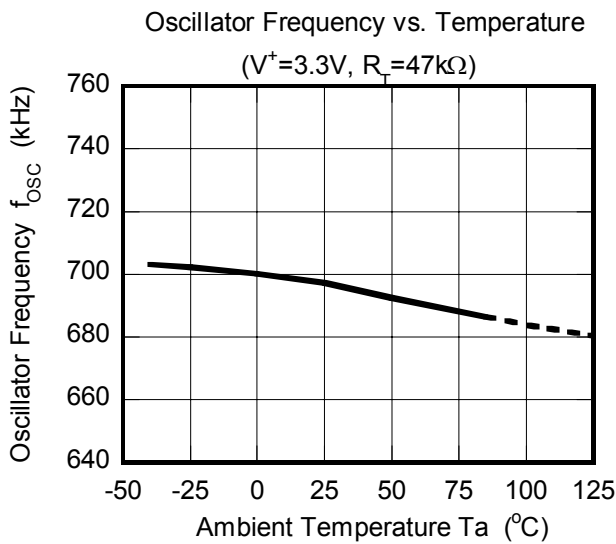
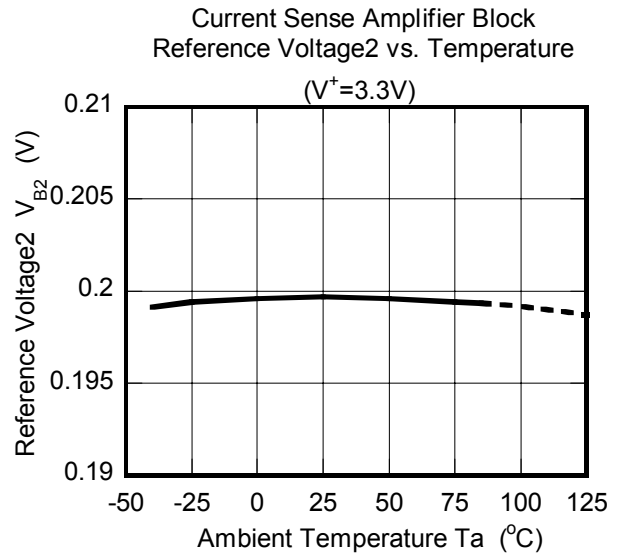
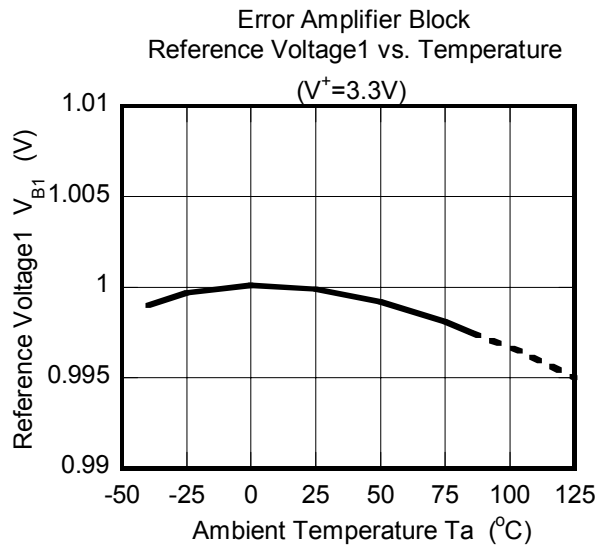

MEMO

[CAUTION]

The specifications on this databook are only given for information, without any guarantee as regards either mistakes or omissions. The application circuits in this databook are described only to show representative usages of the product and not intended for the guarantee or permission of any right including the industrial rights.