

## Step-Up / Flyback switching regulator IC with standby function

### ■GENERAL DESCRIPTION

The **NJU7602** is a low voltage operation high-speed switching regulator control IC for step-up and flyback converter, with a standby function. It incorporates a totem pole output, which can drive an external MOS-FET easily. The NJU7602 also has a soft-start function, dead time control and timer latch for short circuit protection and their times are all adjustable with external parts. Further the internal standby function minimize the current during non-active condition. It is available in 8-lead DMP and MSOP (TVSP) packages, and it is suitable for battery powered applications.

### ■PACKAGE OUTLINE

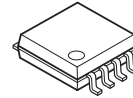

**NJU7602M**  
(DMP8)



**NJU7602RB1**  
(MSOP8(TVSP8))

### ■FEATURES

- PWM switching control
- Standby Function
- Operating Voltage                    2.2V to 8V
- Wide Oscillator Range                300kHz to 1MHz
- Maximum Duty Cycle                 90% typ.
- Quiescent Current                     Operating :800μA typ.  
   Standby :1μA max.
- Soft-Start Function                    Internal :16ms typ. or adjustable
- Dead Time Control
- Timer Latch for Short Circuit Protection
- C-MOS Technology
- Package Outline                        NJU7602M : DMP8  
   NJU7602RB1 : MSOP8 (TVSP8)\*

\*MEET JEDEC MO-187-DA/ THIN TYPE

### ■PRODUCT VARIATION

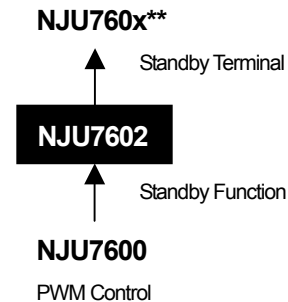

\*\* Planning

### ■PIN CONFIGURATION

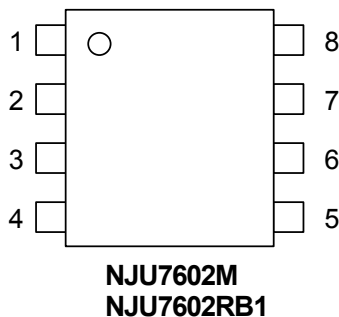

#### PIN FUNCTION

1. V<sup>+</sup>
2. FB
3. IN-
4. SCP
5. DTC
6. RT
7. GND
8. OUT

# NJU7602

## ■BLOCK DIAGRAM

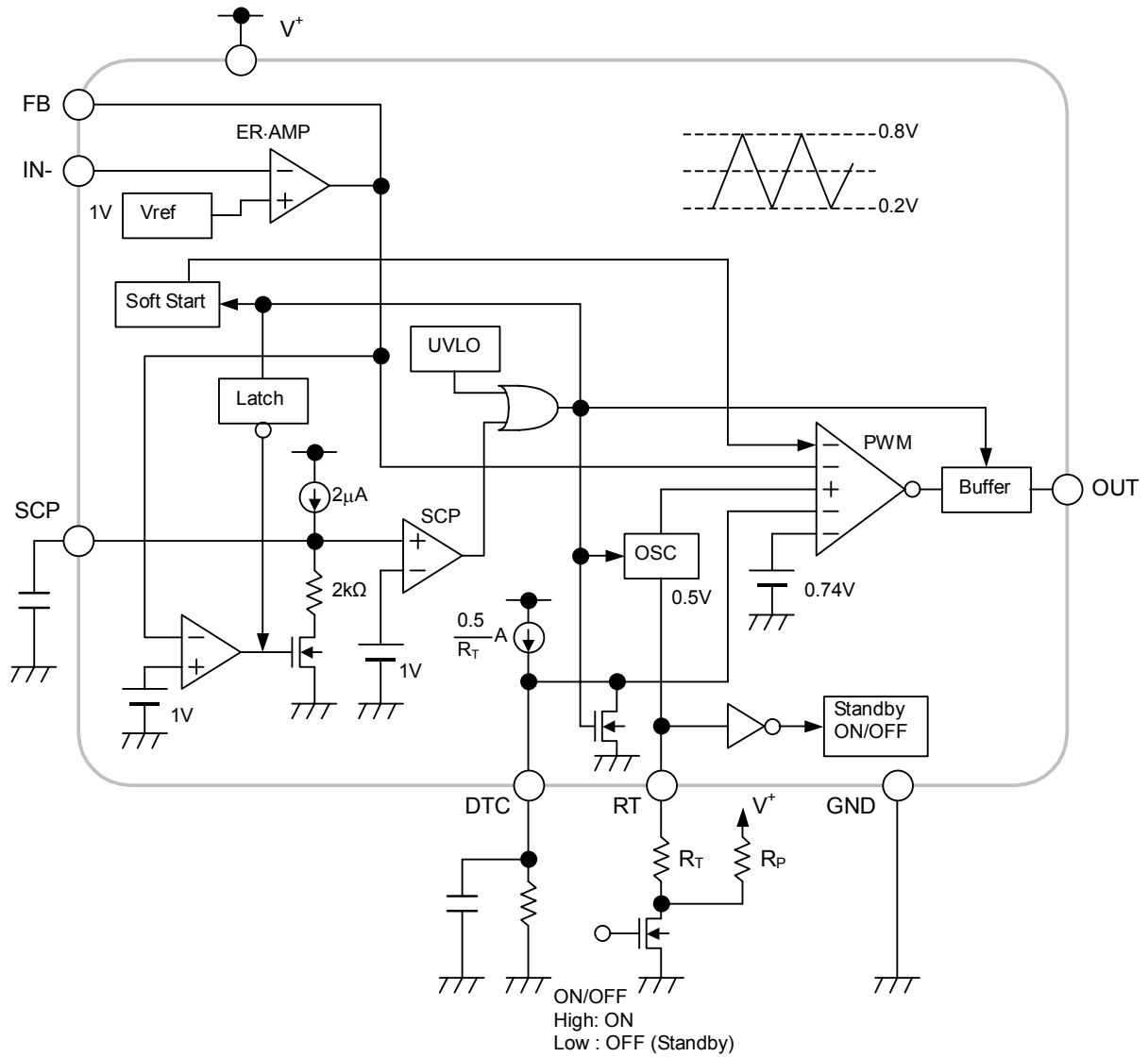

## ■ABSOLUTE MAXIMUM RATINGS

(Ta=25°C)

PARAMETER	SYMBOL	MAXIMUM RATINGS	UNIT
Supply Voltage	V <sup>+</sup>	+9	V
Output Pin Current	I <sub>O</sub>	±50	mA
Power Dissipation	P <sub>D</sub>	DMP8 :300 MSOP8 (TVSP8) :320	mW
Operating Temperature Range	T <sub>OPR</sub>	-40 to +85	°C
Storage Temperature Range	T <sub>STG</sub>	-40 to +125	°C

## ■RECOMMENDED OPERATING CONDITIONS

(Ta=25°C)

PARAMETER	SYMBOL	MIN.	TYP.	MAX.	UNIT
Operating Voltage	V <sup>+</sup>	2.2	—	8	V
Oscillator Timing Resistor	R <sub>T</sub>	30	47	120	kΩ
Oscillation Frequency	f <sub>OSC</sub>	300	700	1,000	kHz

## ■ELECTRICAL CHARACTERISTICS

(V<sup>+</sup>=3.3V, R<sub>T</sub>=47kΩ, Ta=25°C)

PARAMETER	SYMBOL	TEST CONDITION	MIN.	TYP.	MAX.	UNIT
<b>Under Voltage Lockout Block</b>						
ON Threshold Voltage	V <sub>T_ON</sub>	V <sup>+</sup> = L → H	1.9	2.0	2.1	V
OFF Threshold Voltage	V <sub>T_OFF</sub>	V <sup>+</sup> = H → L	1.8	1.9	2.0	V
Hysteresis Voltage	V <sub>HYS</sub>		60	100	—	mV
<b>Soft Start Block</b>						
Soft Start Time	T <sub>SS</sub>	V <sub>T_ON</sub> → Duty=80%	8	16	24	ms
<b>Short Circuit Protection Block</b>						
Input Threshold Voltage	V <sub>T_PC</sub>	FB Pin	0.95	1.00	1.05	V
Charge Current	I <sub>CHG</sub>	V <sub>SCP</sub> =0V	1.5	2	2.5	μA
Latch Mode ON Threshold Voltage	V <sub>T_LA</sub>	SCP Pin	0.95	1.00	1.05	V
Latch Mode OFF Threshold Voltage	V <sub>T_LAOFF</sub>	SCP Pin	0.2	0.45	0.7	V
<b>Oscillator Block</b>						
RT Pin Voltage	V <sub>RT</sub>		-5%	0.5	+5%	V
Oscillation Frequency	f <sub>OSC</sub>		630	700	770	kHz
Oscillate Supply Voltage Fluctuations	f <sub>DV</sub>	V <sup>+</sup> =2.2V to 8V	—	1	—	%
Oscillate Temperature Fluctuations	f <sub>DT</sub>	Ta=-40°C to +85°C	—	3	—	%
Standby RT Terminal Resistance	R <sub>T_STB</sub>		—	2	—	MΩ

# NJU7602

## ■ ELECTRICAL CHARACTERISTICS

( $V^+=3.3V$ ,  $R_T=47k\Omega$ ,  $T_a=25^\circ C$ )

PARAMETER	SYMBOL	TEST CONDITION	MIN.	TYP.	MAX.	UNIT
<b>Error Amplifier Block</b>						
Reference Voltage	$V_B$		-1.5%	1.00	+1.5%	V
Input Bias Current	$I_B$		-0.1	–	0.1	$\mu A$
Open Loop Gain	$A_V$		–	80	–	dB
Gain Bandwidth Product	$G_B$		–	1	–	MHz
Output Source Current	$I_{OM+1}$	$V_{FB}=1V, V_{IN}=0.9V$	20	45	70	mA
	$I_{OM+2}$	$V_{FB}=1V, V_{IN}=0.9V, V^+=2.2V$	4	9	16	mA
Output Sink Current	$I_{OM-}$	$V_{FB}=1V, V_{IN}=1.1V$	0.10	0.16	0.22	mA
<b>PWM Complete Block</b>						
Input Threshold Voltage	$V_{T0}$	Duty=0%	0.16	0.22	0.28	V
	$V_{T50}$	Duty=50%	0.44	0.5	0.56	V
Maximum Duty Cycle	$M_{AXDUTY1}$	$V_{FB}=0.9V$	85	90	95	%
	$M_{AXDUTY2}$	$V_{FB}=0.9V, R_{DTC}=47k\Omega$	40	50	60	%
<b>Output Block</b>						
Output High Level ON Resistance	$R_{OH}$	$I_O=-20mA$	–	10	20	$\Omega$
Output Low Level ON Resistance	$R_{OL}$	$I_O=+20mA$	–	5	10	$\Omega$
<b>General Characteristics</b>						
Quiescent Current	$I_{DD}$	$R_L=Non\ Load$	–	800	1200	$\mu A$
Standby Quiescent Current	$I_{DD\ STB}$	$R_T=Open$	–	–	1.0	$\mu A$

## ■ TYPICAL APPLICATIONS

### Step-Up Converter

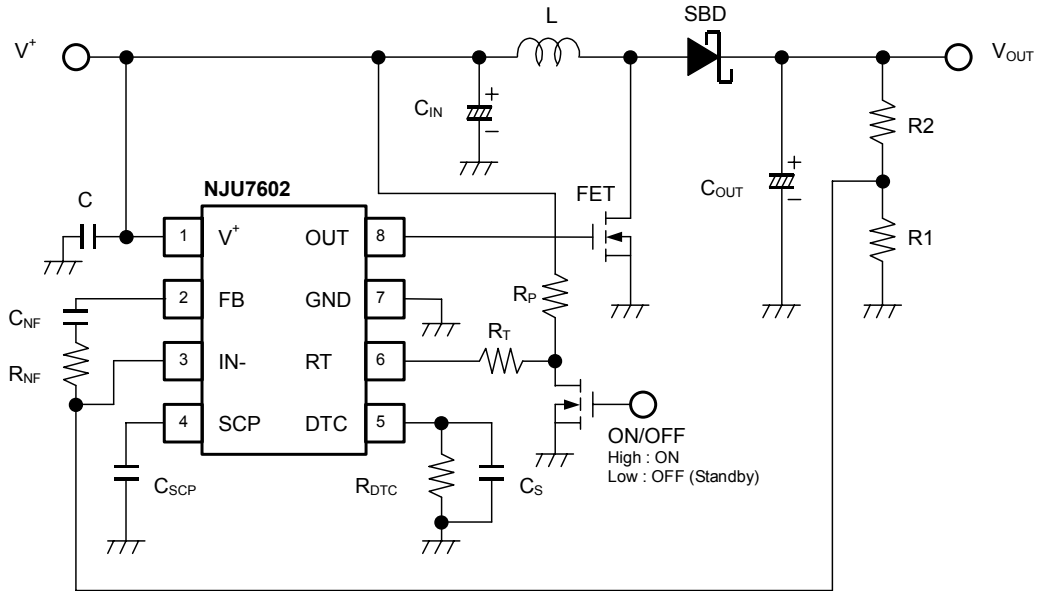

### Flyback Converter

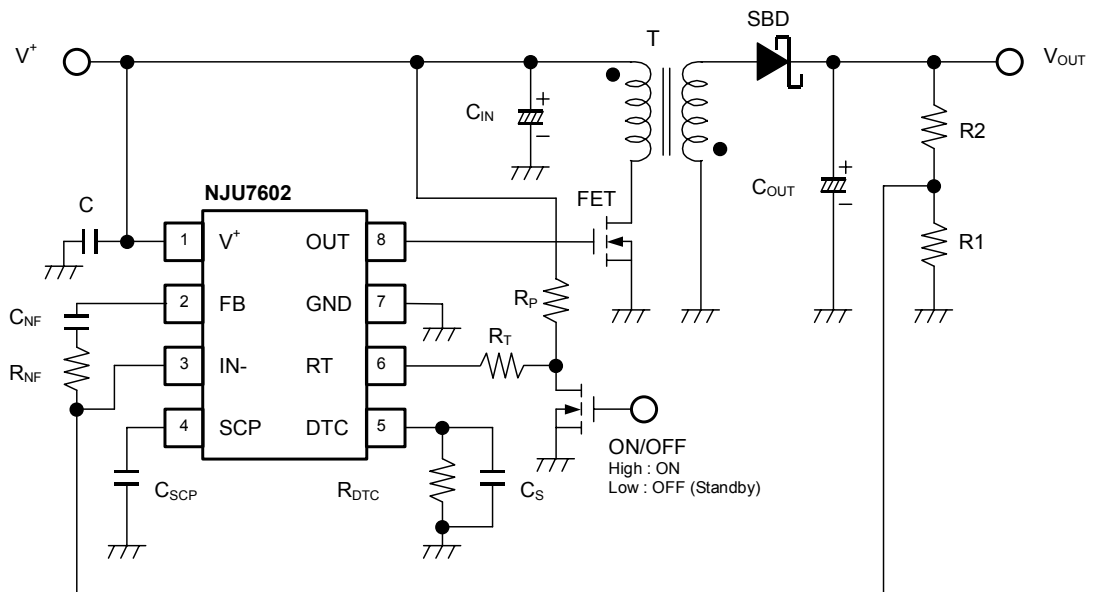

## ■ TYPICAL CHARACTERISTICS

Oscillation Frequency vs. Timing Resistance

( $V^+ = 3.3V, T_a = 25^\circ C$ )

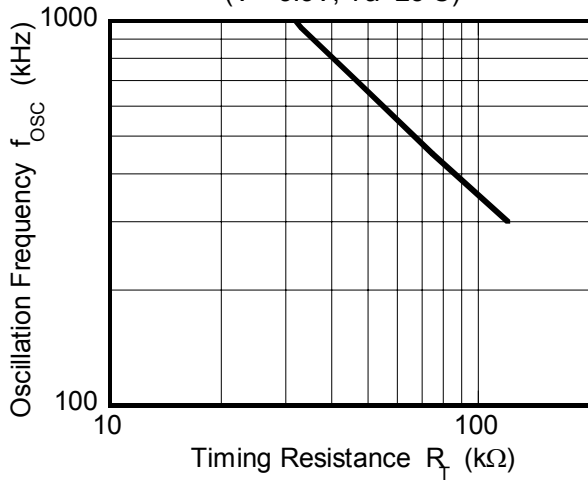

Maximum Duty Cycle vs. Oscillator Frequency

( $V^+ = 3.3V, T_a = 25^\circ C$ )

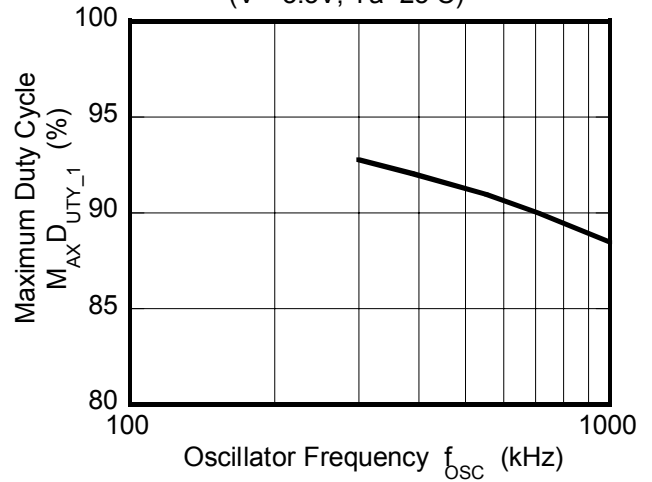

Oscillation Frequency vs. Operating Voltage

( $R_T = 47k\Omega, T_a = 25^\circ C$ )

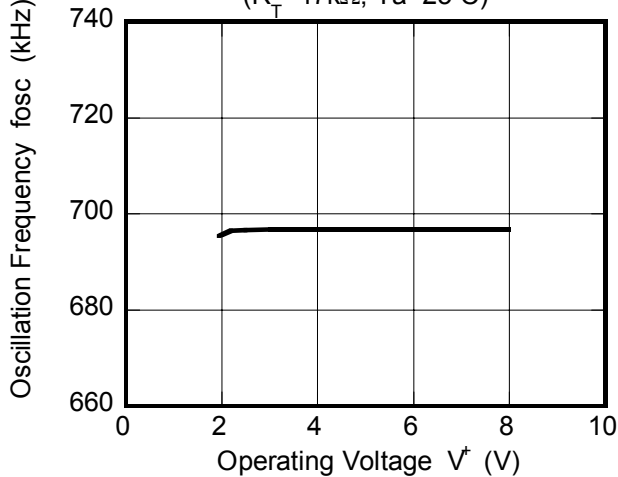

Duty Cycle vs.  $R_{DTC}$

( $V^+ = 3.3V, R_T = 47k\Omega, T_a = 25^\circ C$ )

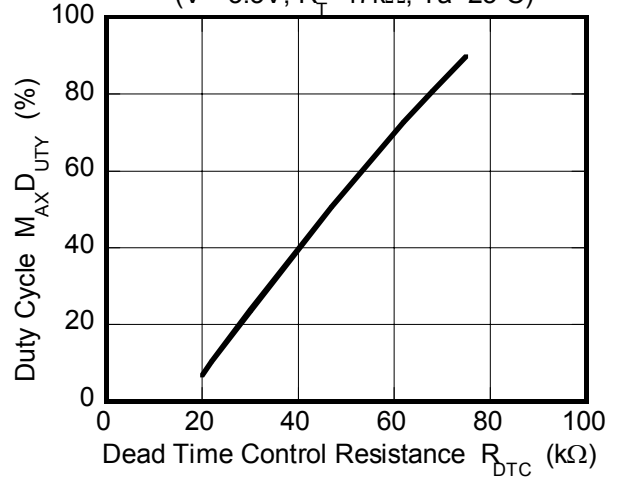

Reference Voltage vs. Operating Voltage

( $T_a = 25^\circ C$ )

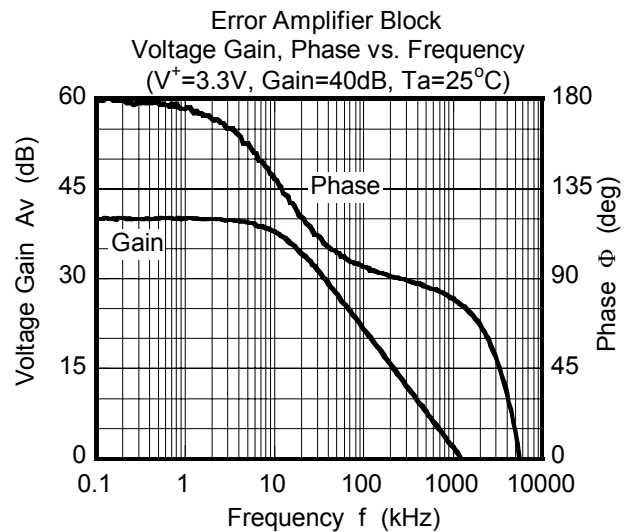
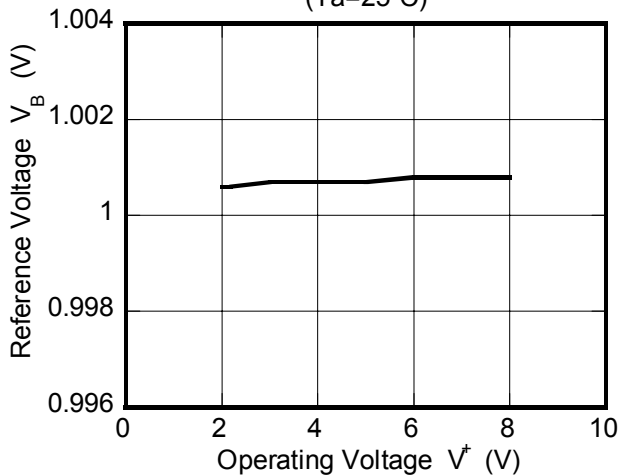

## ■ TYPICAL CHARACTERISTICS

Quiescent Current vs. Operating Voltage  
( $R_T=47k\Omega$ ,  $R_L=Non\ Load$ ,  $T_a=25^\circ C$ )

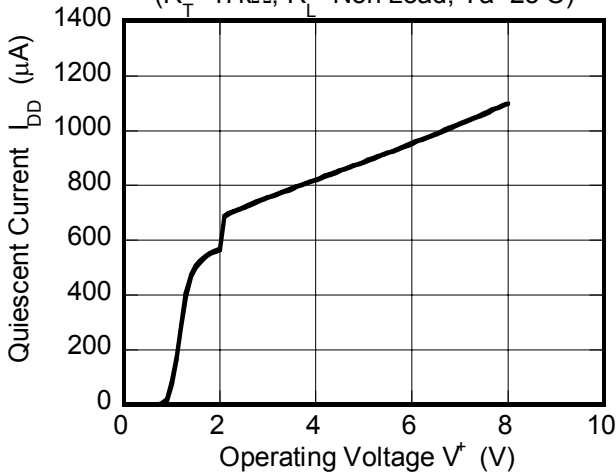

Standby Current vs. Operating Voltage  
( $R_T=Open$ ,  $T_a=25^\circ C$ )

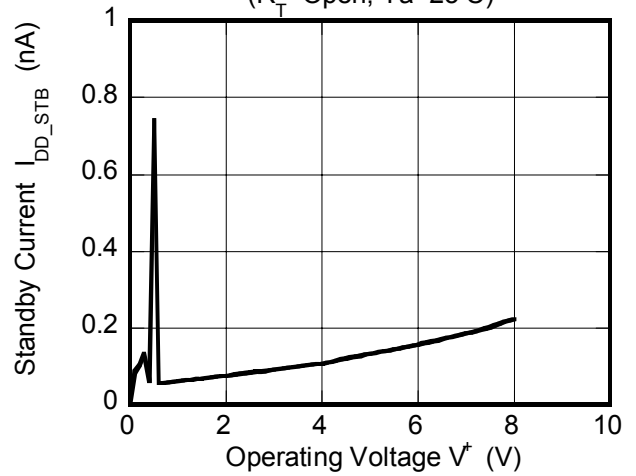

Output Block  
Output High Level ON Resistance  
vs. Temperature ( $I_o=-20mA$ )

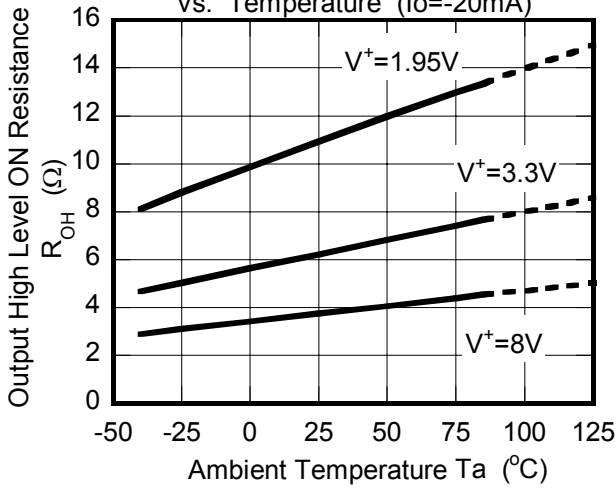

Output Block  
Output Low Level ON Resistance  
vs. Temperature ( $I_o=+20mA$ )

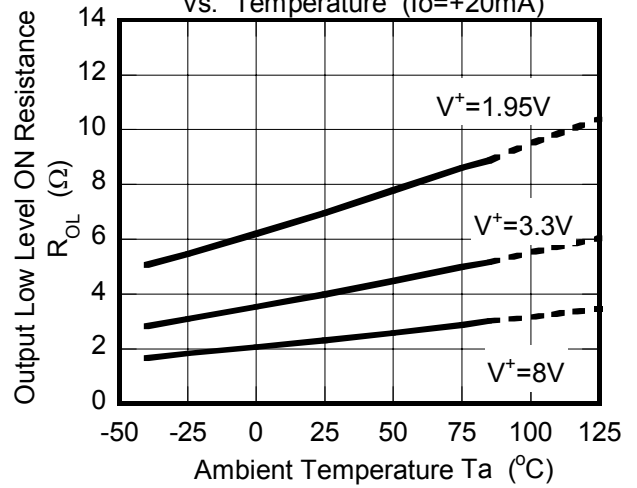

Error Amplifier Block  
Output Source Current vs. Temperature  
( $V_{FB}=1V$ ,  $V_{IN-}=0.9V$ )

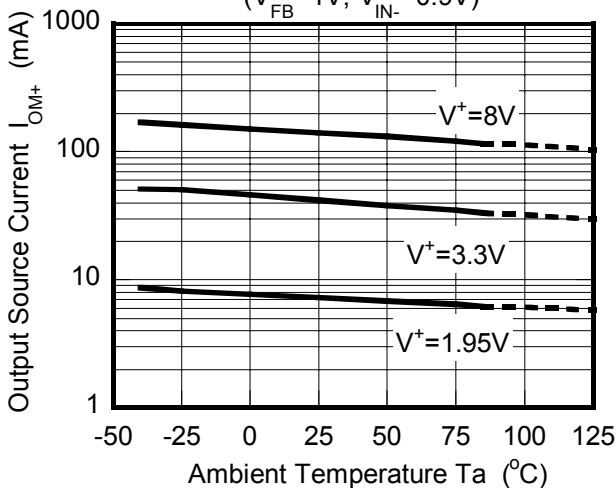

Error Amplifier Block  
Output Sink Current vs. Temperature  
( $V_{FB}=1V$ ,  $V_{IN-}=1.1V$ )

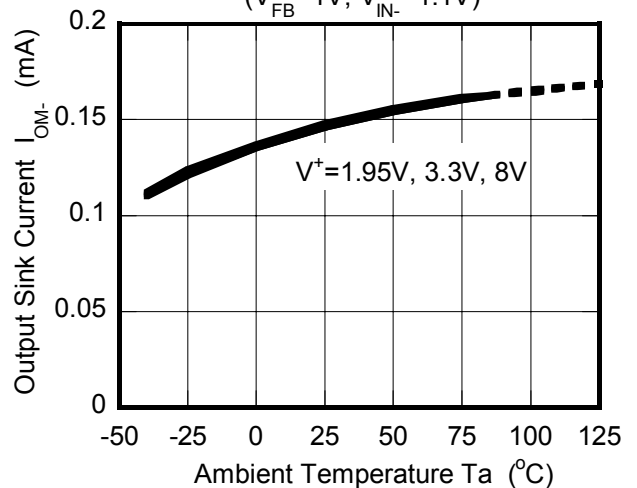

## ■ TYPICAL CHARACTERISTICS

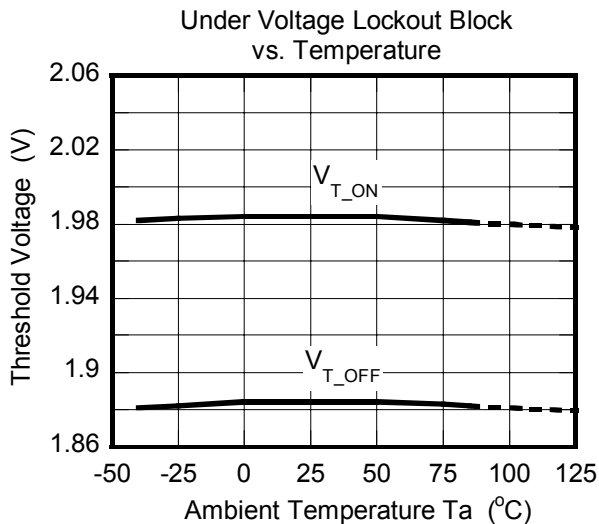
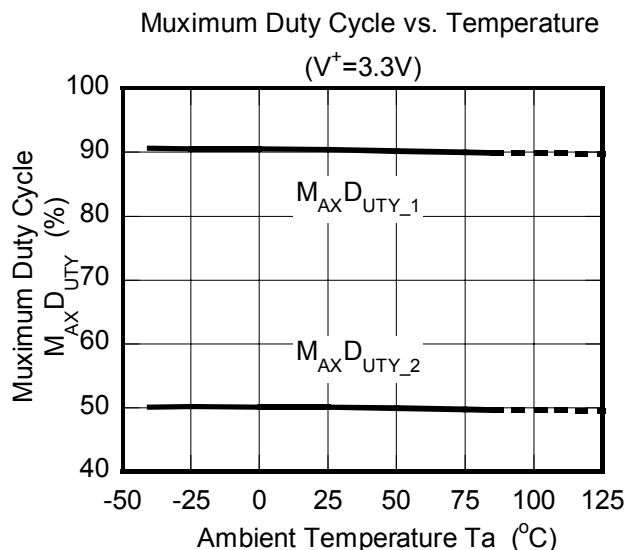
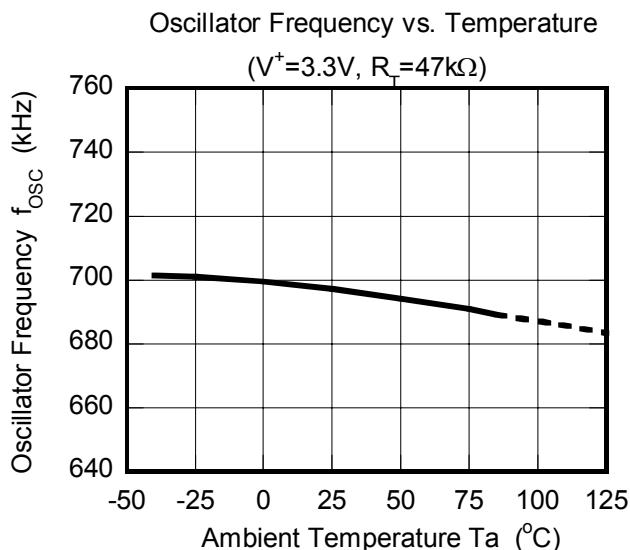
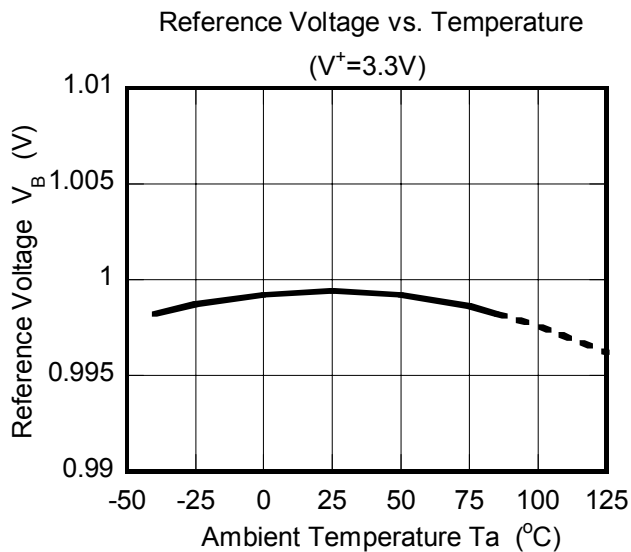
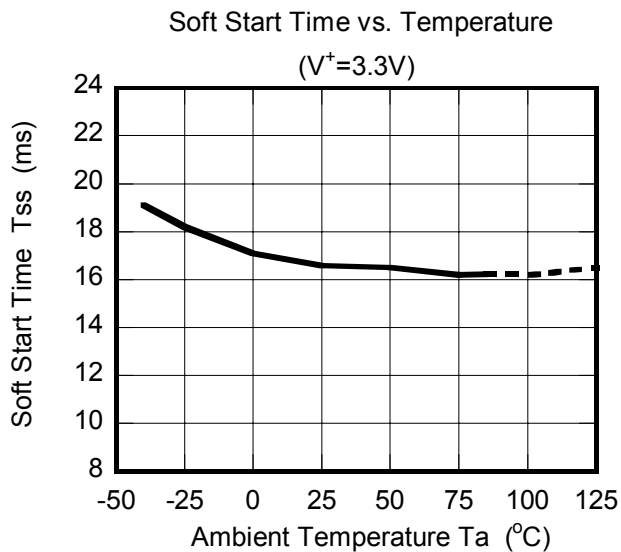



## ■ TYPICAL CHARACTERISTICS

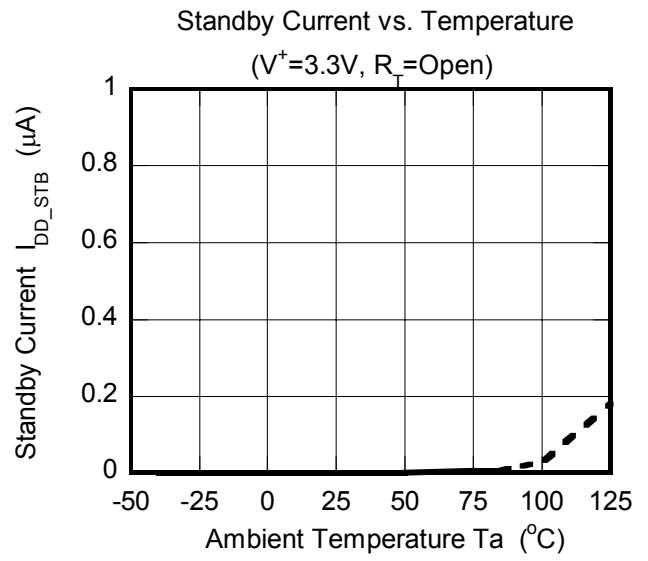
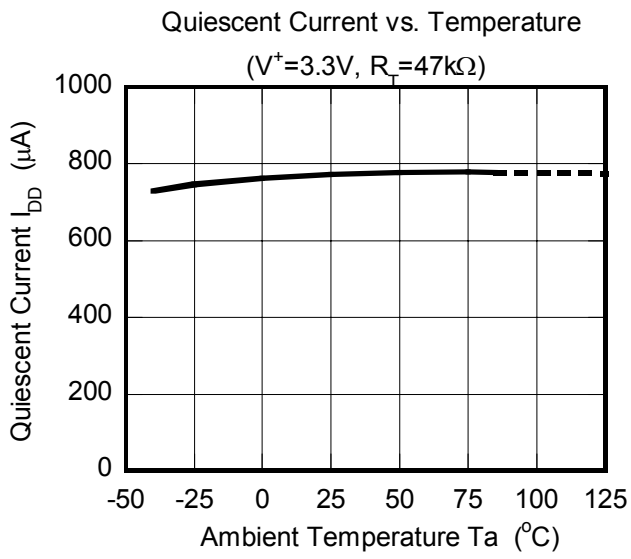

## MEMO

**[CAUTION]**

The specifications on this databook are only given for information, without any guarantee as regards either mistakes or omissions. The application circuits in this databook are described only to show representative usages of the product and not intended for the guarantee or permission of any right including the industrial rights.