

HIGH SPEED SINGLE SUPPLY OPERATIONAL AMPLIFIER

■FEATURES

- Low Input Offset Voltage 3.5mV max.
- Low Input Offset Voltage Drift
 - NJM842 3.5 μ V/°C
 - NJM844 5 μ V/°C
- High Slew Rate 8.5V/ μ s
- High Unity Gain Frequency 3.5MHz
- Single Supply 3V to 36V
- Operating Temperature Range -40°C to +125°C
- Low input voltage around GND level
- Unity-Gain Stable ($C_L=1000$ pF)
- No Phase Reversal
- High EMI Immunity
- Output Short-Circuit Protection
- Operating Current (All amplifiers)
 - NJM842 4.3mA
 - NJM844 8.8mA
- Package
 - NJM842 SOP8, SSOP8, MSOP8(VSP8)
 - NJM844 SOP14, SSOP14

■GENERAL DESCRIPTION

The NJM842/NJM844 are high speed single supply operational amplifier.

These amplifiers feature is low-offset voltage, low-offset voltage drift, 8.5V/ μ s slew rate, 3.5MHz gain bandwidth and unity-gain stable ($C_L=1000$ pF).

As a further feature, wide operation voltage range and wide operation temperature range are suitable for power supply unit, general-purpose inverters and high performance industrial equipment.

■APPLICATIONS

- Motor, Inverter Current Sense Application
- Power Supply Application
- Buffer Application Amplifier
- Active filter

■PIN CONFIGURATION / PRODUCT INFORMATION

PIN FUNCTION						
	PACKAGE	SOP8	SSOP8	MSOP8(VSP8)	SOP14	SSOP14
PART NUMBER	NJM842G	NJM842V	NJM842R	NJM844G	NJM844V	

■ABSOLUTE MAXIMUM RATINGS (Ta=25°C, unless otherwise noted.)

PARAMETER	SYMBOL	RATING	UNIT
Supply Voltage	$V^+ - V^-$	38 ⁽⁵⁾	V
Differential Input Voltage ⁽¹⁾	V_{ID}	± 36 ⁽²⁾	V
Input Voltage ⁽²⁾	V_{IN}	$V^- - 0.3$ to $V^+ + 36$	V
Output Terminal Input Voltage	V_O	$V^- - 0.3$ to $V^+ + 0.3V$	V
Power Dissipation ⁽³⁾	P_D	(2-layer / 4-layer)	mW
SOP8		780 / 1200	
SSOP8		510 / 650	
MSOP8(VSP8)		600 / 810	
SOP14		1200 / 1900	
SSOP14		600 / 770	
Output Short-Circuit Duration ⁽⁴⁾		infinite	
Operating Temperature Range	T_{opr}	-40 to +125	°C
Storage Temperature Range	T_{stg}	-55 to +150	°C

(1) Differential voltage is the voltage difference between +INPUT and -INPUT.

(2) Input voltage should be allowed to apply to the input terminal independent of the magnitude of V^+ . The normal operation will establish when any input is within the Common Mode Voltage Range of electrical characteristics.

(3) Power dissipation is the power that can be consumed by the IC at $T_a=25^\circ\text{C}$, and is the typical measured value based on JEDEC condition. When using the IC over $T_a=25^\circ\text{C}$ subtract the value $[\text{mW}/^\circ\text{C}]=P_D/(T_{stg}(\text{MAX})-25)$ per temperature.

2-layer: EIA/JEDEC STANDARD Test board (76.2x114.3x1.6mm, 2layers, FR-4) mounting

4-layer: EIA/JEDEC STANDARD Test board (76.2x114.3x1.6mm, 4layers, FR-4) mounting

(4) Temperature and/or supply voltages must be limited to ensure the maximum dissipation rating is not exceeded.

(5) Supply Voltage is the voltage difference between V^+ and V^- .

Figure1A. Power Dissipation vs. Temperature

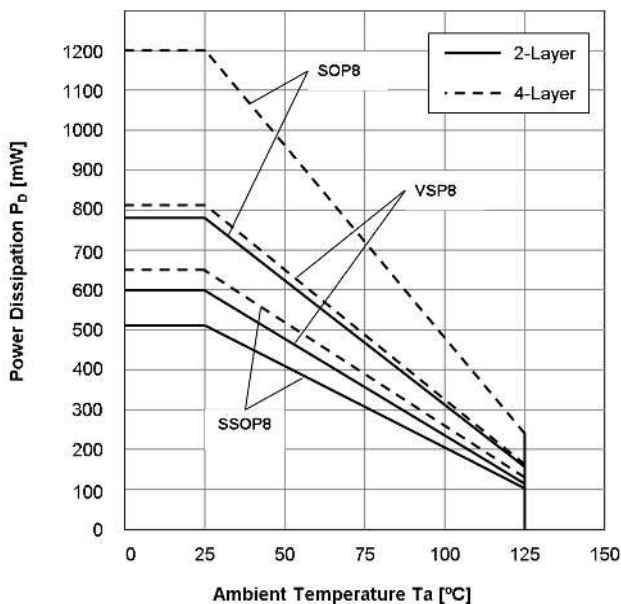
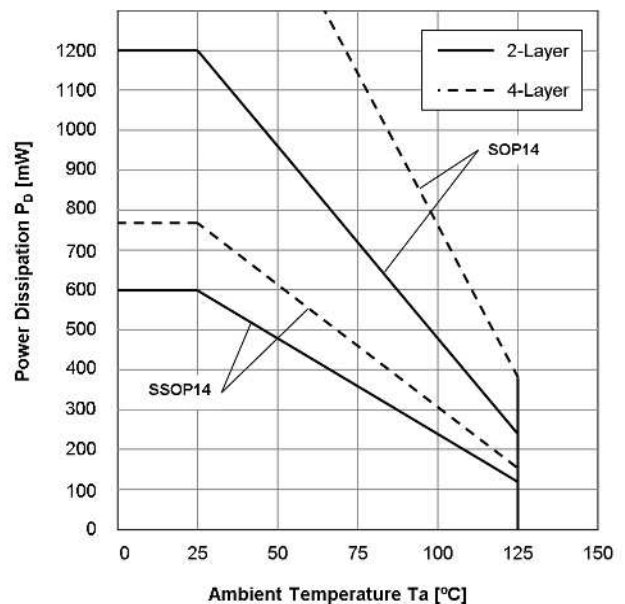

Figure1B. Power Dissipation vs. Temperature



■RECOMMENDED OPERATING CONDITIONS (Ta=25°C)

PARAMETER	Supply Voltage	UNIT
Supply Voltage	+3 to +36 (± 1.5 to ± 18)	V

■ELECTRICAL CHARACTERISTICS ($V^+=+15V$, $V^-=-15V$, $V_{CM}=0V$, $T_a=25^\circ C$ unless otherwise noted)

PARAMETER	SYMBOL	TEST CONDITION	MIN.	TYP.	MAX.	UNIT
INPUT CHARACTERISTICS						
Input Offset Voltage	V_{IO}	$R_S=50\Omega$, $V_{CM}=0V$	-	0.8	3.5	mV
Input Offset Voltage Drift NJM842 NJM844	$\Delta V_{IO}/\Delta T$	$T_a=-40^\circ C \sim +125^\circ C$	- -	3.5 5	- -	$\mu V/^\circ C$ $\mu V/^\circ C$
Input Bias Current	I_B		-	120	500	nA
Input Offset Current	I_{IO}		-	6	75	nA
Open-Loop Voltage Gain	A_V	$V_O=\pm 10V$, $R_L=2k\Omega$ to $0V$	88	110	-	dB
Common Mode Rejection Ratio	CMR	$V_{ICM}=-15V$ to $13.2V$	70	86	-	dB
Common Mode Input Voltage Range	V_{ICM}	CMR ≥ 70 dB	V^-	-	$V^+-1.8$	V
OUTPUT CHARACTERISTICS						
High-level Output Voltage	V_{OH}	$R_L=10k\Omega$ to $0V$	13.7	14	-	V
		$R_L=2k\Omega$ to $0V$	13.5	14	-	
Low-level Output Voltage	V_{OL}	$R_L=10k\Omega$ to $0V$	-	-14.3	-13.7	V
		$R_L=2k\Omega$ to $0V$	-	-13.8	-13.5	
Output Source Current	I_{SOURCE}	$V_O=0V$, +Input=+1V, -Input=0V	10	40	-	mA
Output Sink Current	I_{SINK}	$V_O=0V$, +Input=0V, -Input=+1V	10	45	-	mA
POWER SUPPLY						
Supply Current (All amplifiers) NJM842 NJM844	I_{SUPPLY}	No Signal, $R_L=\infty$	-	4.3	5.5	mA mA
			-	8.8	12	
Supply Voltage Rejection Ratio	SVR	$V^+/V^-=\pm 1.5V$ to $\pm 18V$, $V_{ICM}=0V$	70	93	-	dB
AC CHARACTERISTICS						
Gain Bandwidth Product	GBW	$R_L=2k\Omega$ to $0V$, $f=100kHz$	-	3.5	-	MHz
Slew Rate	SR	$G_V=0dB$, $V_{in}=-10V$ to $+10V$, $R_L=2k\Omega$ to $0V$, $C_L=20pF$	-	8.5	-	V/ μs
Phase Margin	Φ_M	$R_L=2k\Omega$ to $0V$, $C_L=20pF$	-	90	-	deg
		$R_L=2k\Omega$ to $0V$, $C_L=330pF$	-	70	-	
Gain Margin	G_M	$R_L=2k\Omega$ to $0V$, $C_L=20pF$	-	9	-	dB
		$R_L=2k\Omega$ to $0V$, $C_L=330pF$	-	8	-	
NOISE, THD						
Equivalent Input Noise Voltage	e_n	$f=1kHz$	-	32	-	nV/ \sqrt{Hz}
Total Harmonic Distortion + Noise	THD+N	$G_V=20dB$, $f=1kHz$, $V_O=15V_{PP}$, $R_L=2k\Omega$ to $0V$, $C_L=20pF$	-	0.003	-	%
Channel Separation	CS	$f=10kHz$, Equivalent Input value	-	120	-	dB

■ELECTRICAL CHARACTERISTICS ($V^+=+5V$, $V^-=0V$, $V_{CM}=2.5V$, $T_a=25^\circ C$ unless otherwise noted)

PARAMETER	SYMBOL	TEST CONDITION	MIN.	TYP.	MAX.	UNIT
INPUT CHARACTERISTICS						
Input Offset Voltage	V_{IO}	$R_S=50\Omega$, $V_{CM}=V^+/2$, $V_O=V^+/2$	-	0.5	3.5	mV
Input Offset Voltage Drift NJM842 NJM844	$\Delta V_{IO}/\Delta T$	$T_a=-40^\circ C \sim +125^\circ C$	- -	2.5 4	- -	$\mu V/^\circ C$ $\mu V/^\circ C$
Input Bias Current	I_B	$V_{CM}=V^+/2$, $V_O=V^+/2$	-	140	500	nA
Input Offset Current	I_{IO}	$V_{CM}=V^+/2$, $V_O=V^+/2$	-	6	75	nA
Open-Loop Voltage Gain	A_V	$V_O=1.5V$ to $3.5V$, $R_L=2k\Omega$ to $0V$	88	110	-	dB
Common Mode Rejection Ratio	CMR	$V_{CM}=0V$ to $3.2V$	70	80	-	dB
Common Mode Input Voltage Range	V_{ICM}	CMR ≥ 70 dB	V^-	-	$V^+-1.8$	V
OUTPUT CHARACTERISTICS						
High-level Output Voltage	V_{OH}	$R_L=2k\Omega$ to $0V$	3.7	4	-	V
Low-level Output Voltage	V_{OL}	$R_L=2k\Omega$ to $0V$	-	0	0	V
Output Source Current	I_{SOURCE}	$V_O=0V$, +Input=+1V, -Input=0V	10	30	-	mA
Output Sink Current	I_{SINK}	$V_O=5V$, +Input=0V, -Input=+1V	10	30	-	mA
POWER SUPPLY						
Supply Current (All amplifiers) NJM842 NJM844	I_{SUPPLY}	No Signal, $R_L=\infty$	- -	3.3 6.6	4.5 9	mA mA
AC CHARACTERISTICS						
Gain Bandwidth Product	GBW	$R_L=2k\Omega$ to $0V$, $f=100kHz$	-	3.5	-	MHz
Slew Rate	SR	$G_V=0dB$, $V_{in}=+0.5V$ to $+3V$, $R_L=2k\Omega$ to $0V$, $C_L=20pF$	-	7	-	V/ μs
Phase Margin	Φ_M	$R_L=2k\Omega$ to $0V$, $C_L=20pF$	-	80	-	deg
		$R_L=2k\Omega$ to $0V$, $C_L=330pF$	-	55	-	
Gain Margin	G_M	$R_L=2k\Omega$ to $0V$, $C_L=20pF$	-	9	-	dB
		$R_L=2k\Omega$ to $0V$, $C_L=330pF$	-	7	-	
NOISE, THD						
Equivalent Input Noise Voltage	e_n	$f=1kHz$	-	30	-	nV/ \sqrt{Hz}

■ ELECTRICAL CHARACTERISTICS

NJM842 : Supply Current vs. Supply Voltage

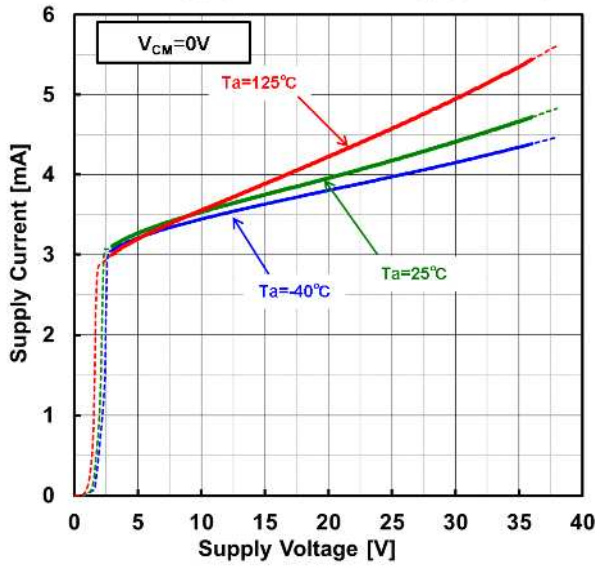

NJM842 : Supply Current vs. Supply Voltage

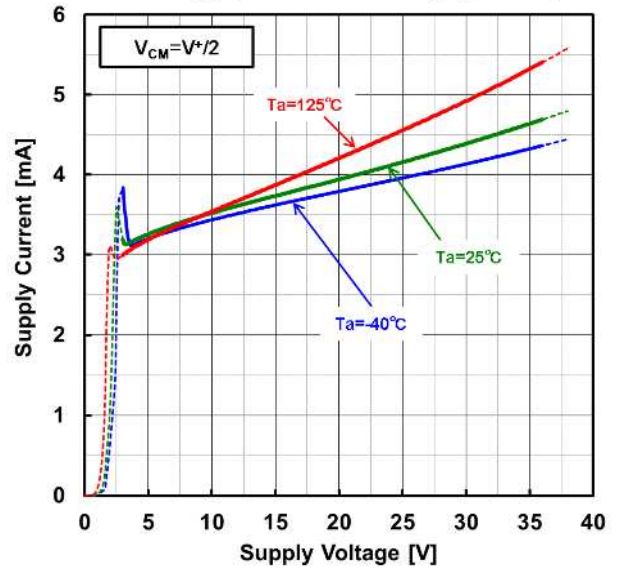

NJM844 : Supply Current vs. Supply Voltage

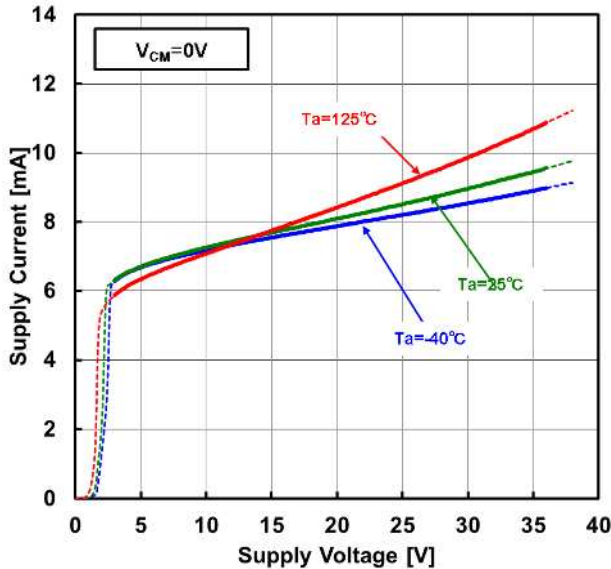

NJM844 : Supply Current vs. Supply Voltage

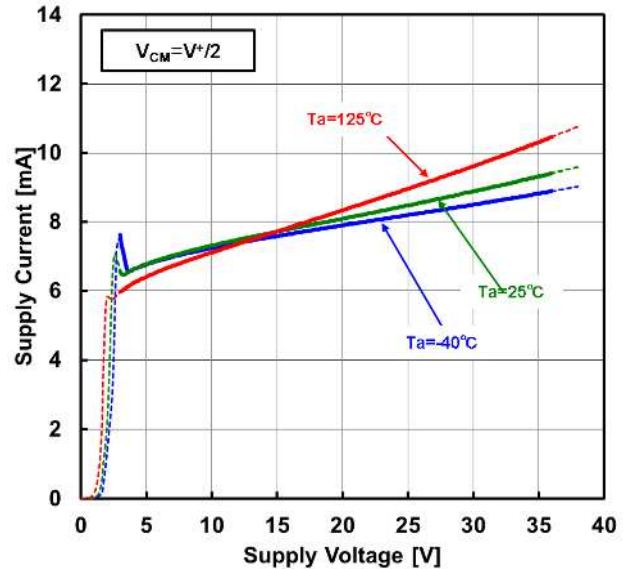

NJM842 : Supply Current vs. Ambient Temperature

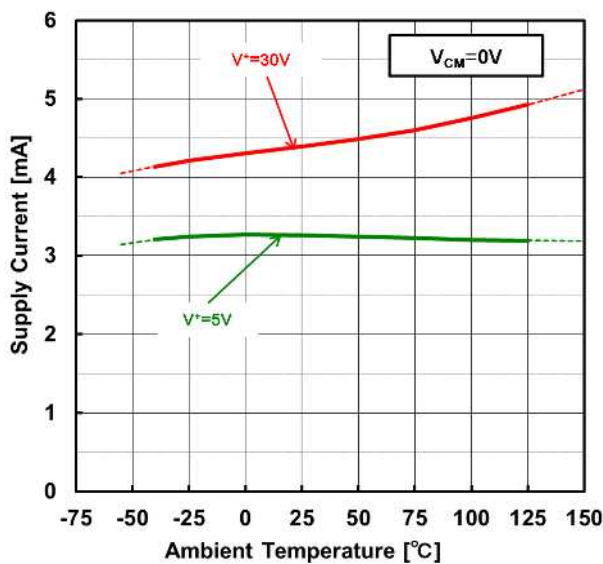

NJM844 : Supply Current vs. Ambient Temperature

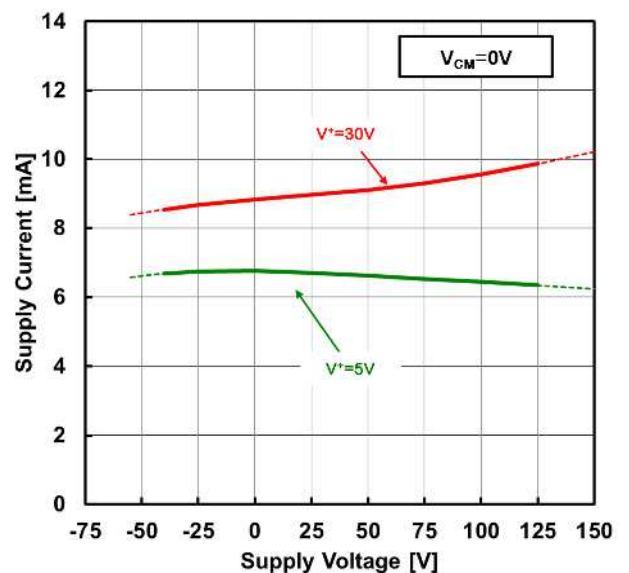

■ ELECTRICAL CHARACTERISTICS

Input Offset Voltage vs. Supply Voltage

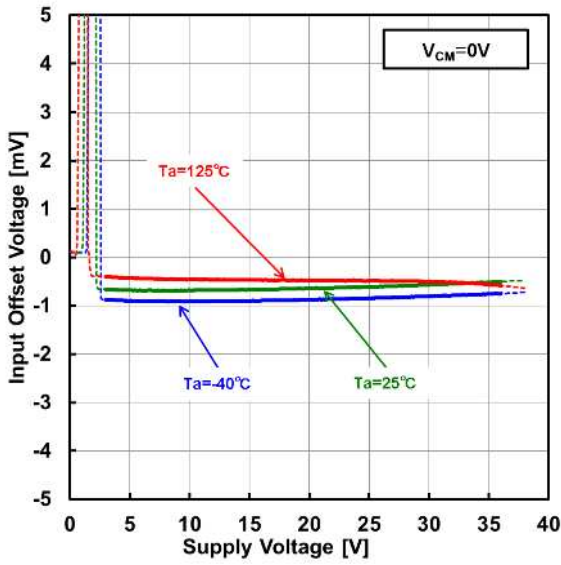

Input Offset Voltage vs. Supply Voltage

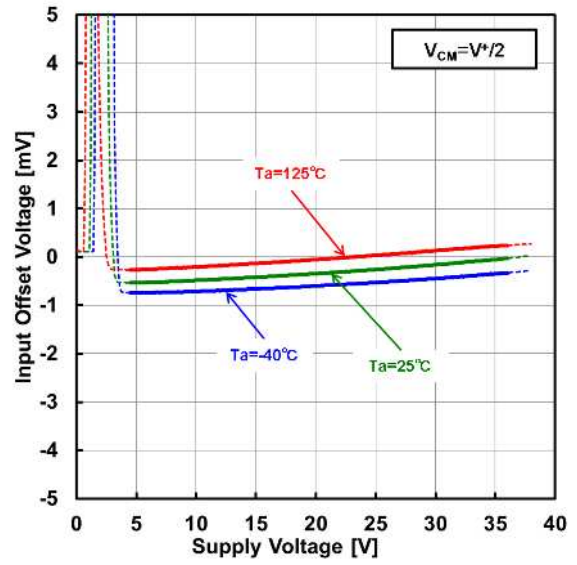

Input Offset Voltage vs. Ambient Temperature

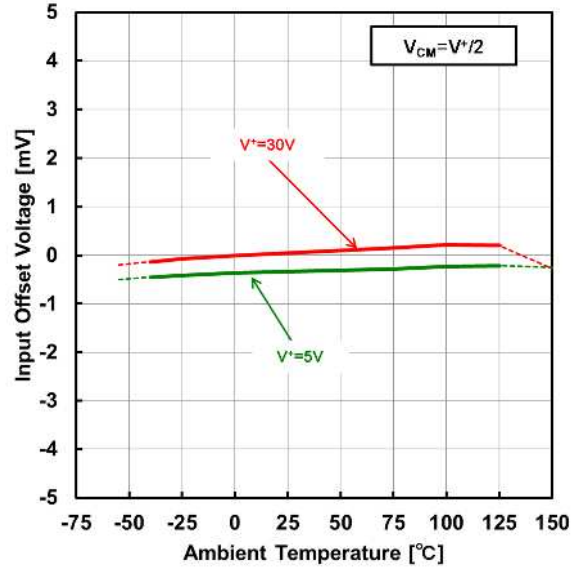

Input Offset Voltage vs. Common-Mode Input Voltage
V*/V=±15V

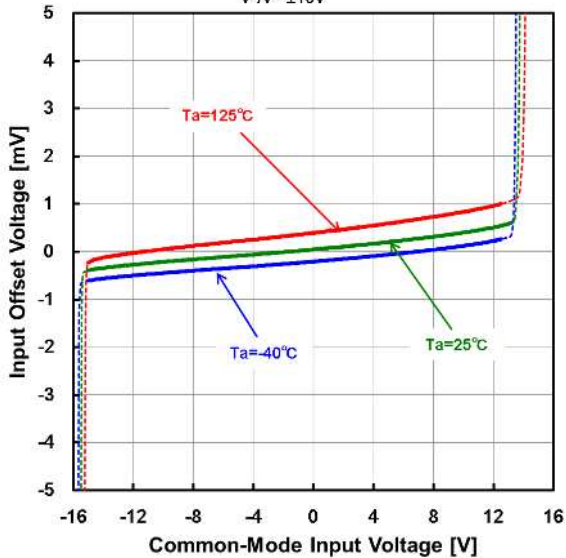

Input Offset Voltage vs. Common-Mode Input Voltage
V*/V=5V

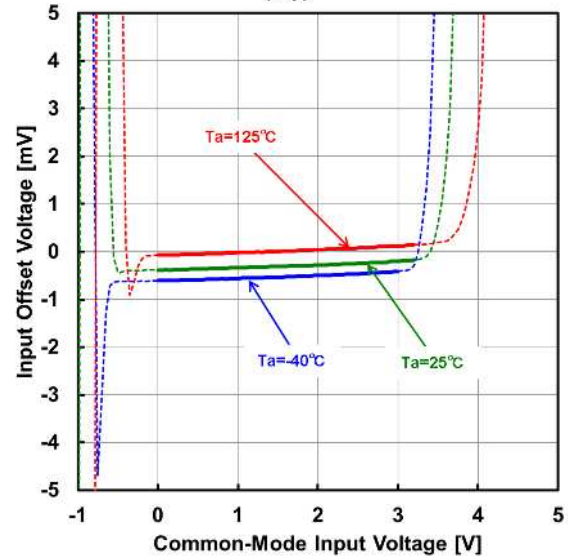

■ ELECTRICAL CHARACTERISTICS

Input Bias Current vs. Ambient Temperature

$V_{CM}=V'/2$

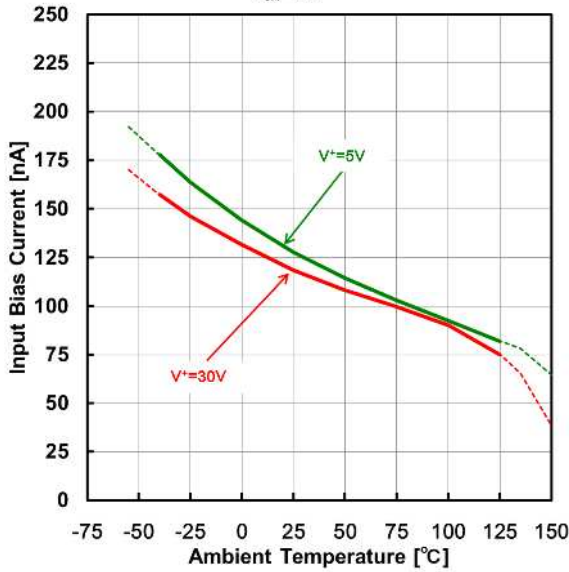

Input Offset Current vs. Ambient Temperature

$V_{CM}=V'/2$

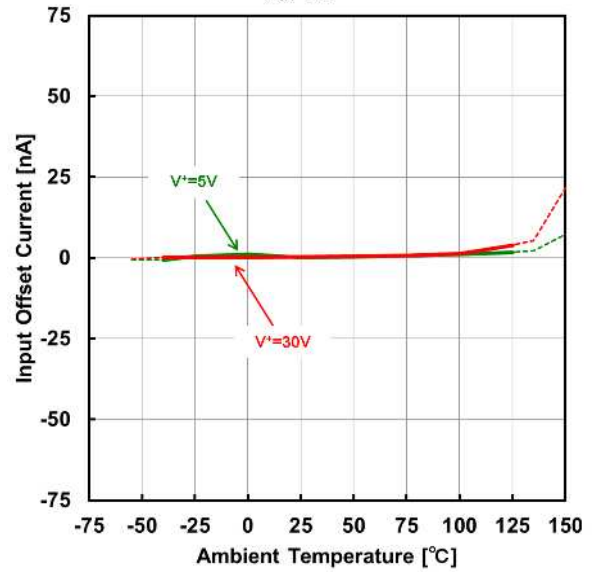

Common-Mode Rejection Ratio vs. Ambient Temperature

$V_{CM}=V'$ to $V'-1.8V$

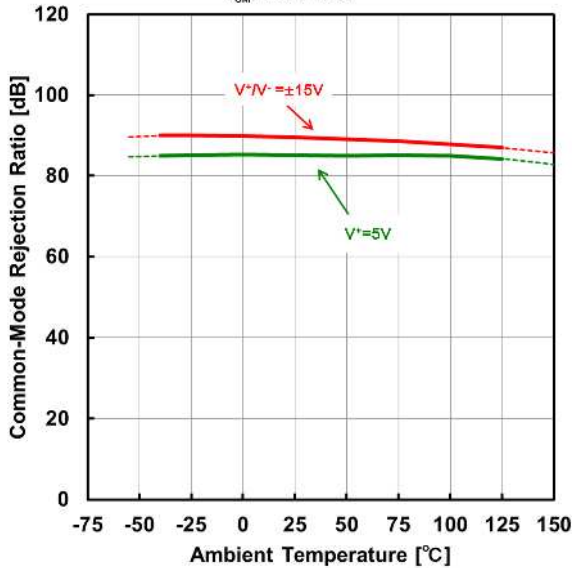

Supply Voltage Rejection Ratio vs. Ambient Temperature

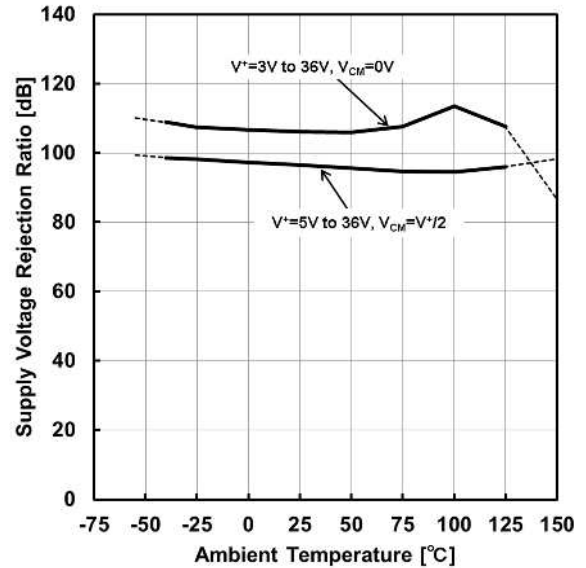

High-Level / Low-Level Output Voltage vs. Ambient Temperature

$V'/V = \pm 15V$

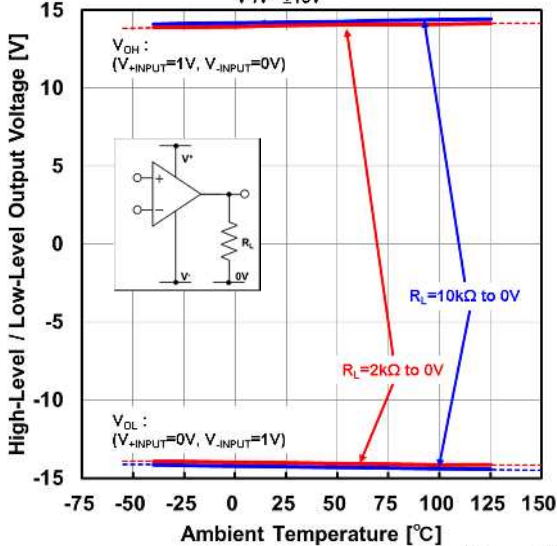

High-Level / Low-Level Output Voltage vs. Ambient Temperature

$V'=5V, V=0V$

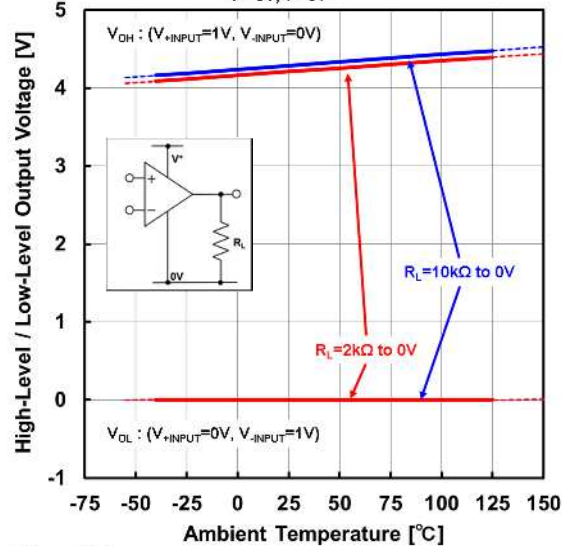

■ ELECTRICAL CHARACTERISTICS

High-Level / Low-Level Output Voltage vs. Load Resistance

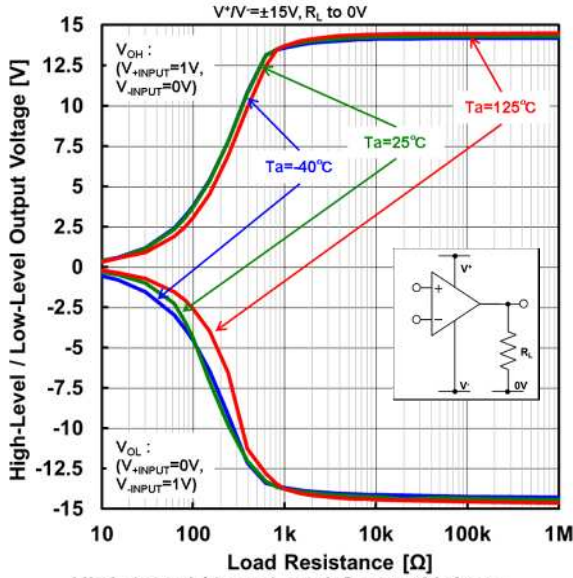

High-Level / Low-Level Output Voltage vs. Load Resistance

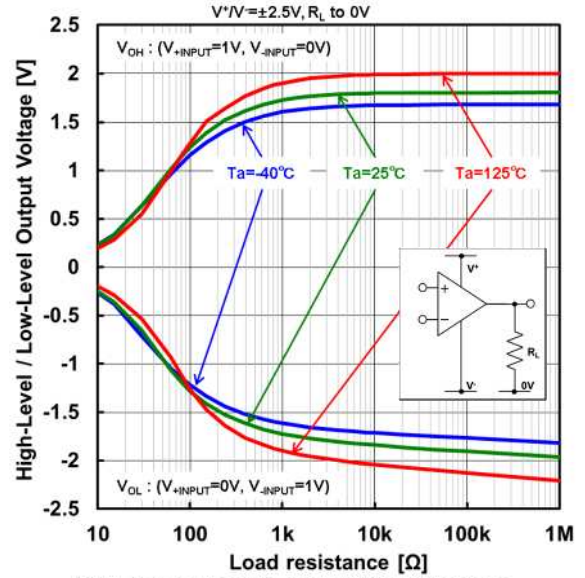

High-Level / Low-Level Output Voltage vs. Load Resistance

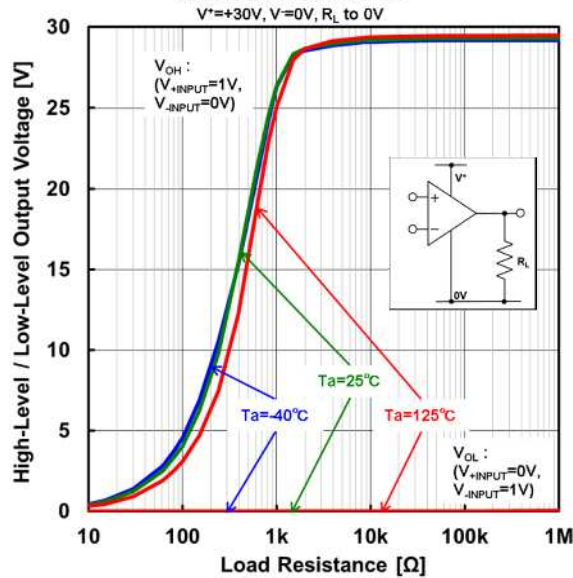

High-Level / Low-Level Output Voltage vs. Load Resistance

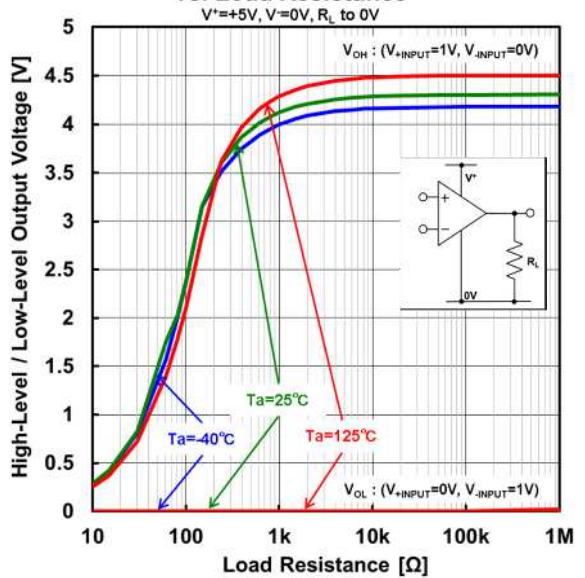

"Enlarged figure"

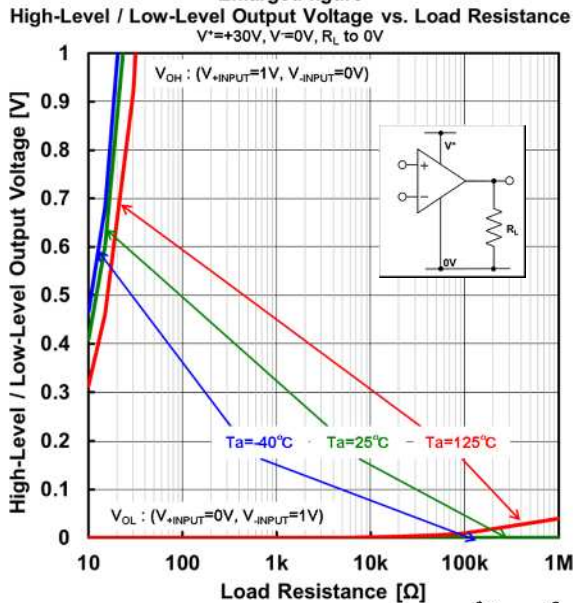

"Enlarged figure"

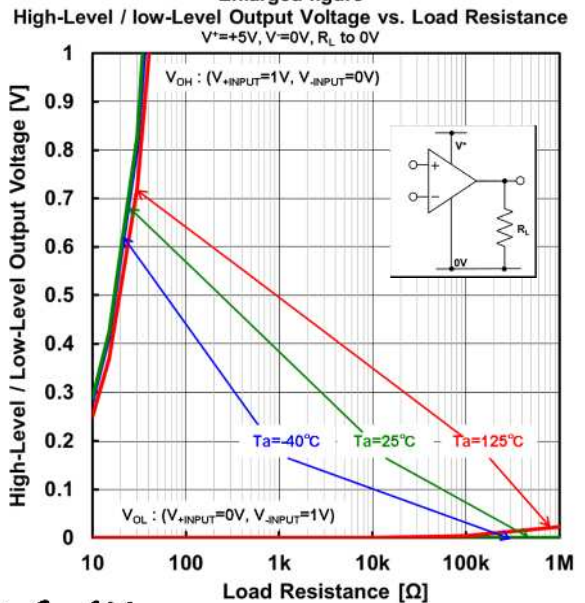

■ ELECTRICAL CHARACTERISTICS

High-Level Output Voltage vs. Output Source Current
 $V^+ / V^- = \pm 15V, V_{+INPUT} = 1V, V_{-INPUT} = 0V$

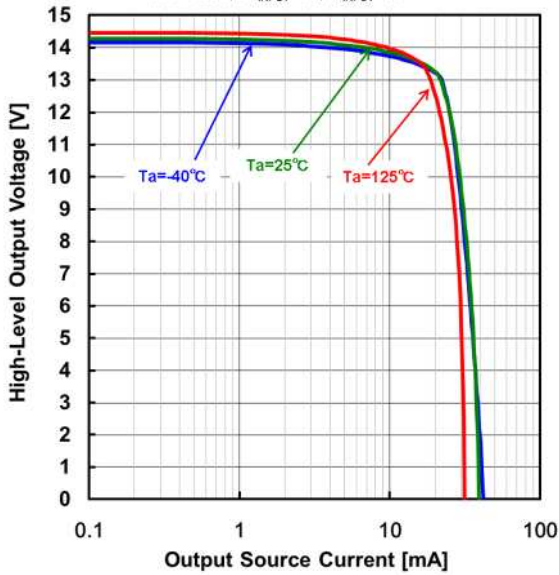

High-Level Output Voltage vs. Output Source Current
 $V^+ = +5V, V^- = 0V, V_{+INPUT} = 1V, V_{-INPUT} = 0V$

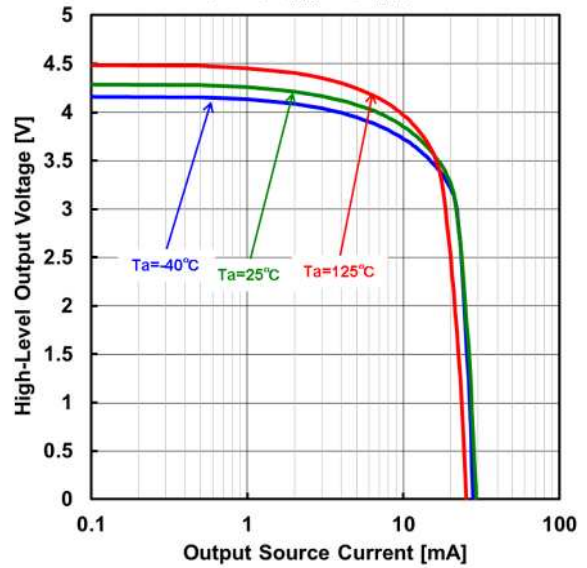

Low-Level Output Voltage vs. Output Sink Current
 $V^+ / V^- = \pm 15V, V_{+INPUT} = 0V, V_{-INPUT} = 1V$

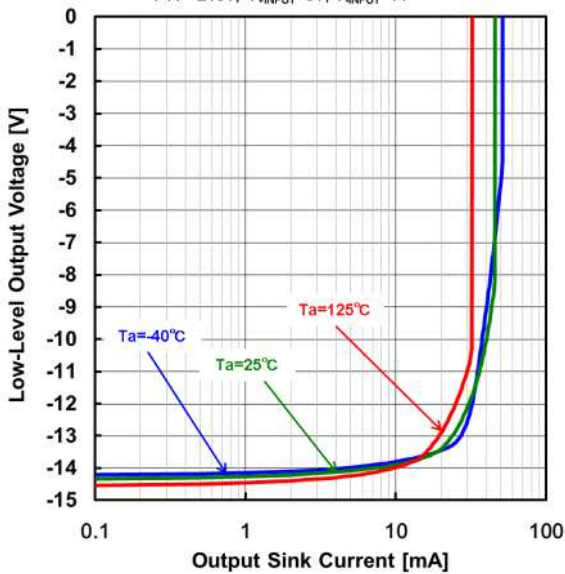

Low-Level Output Voltage vs. Output Sink Current
 $V^+ = +5V, V^- = 0V, V_{+INPUT} = 0V, V_{-INPUT} = 1V$

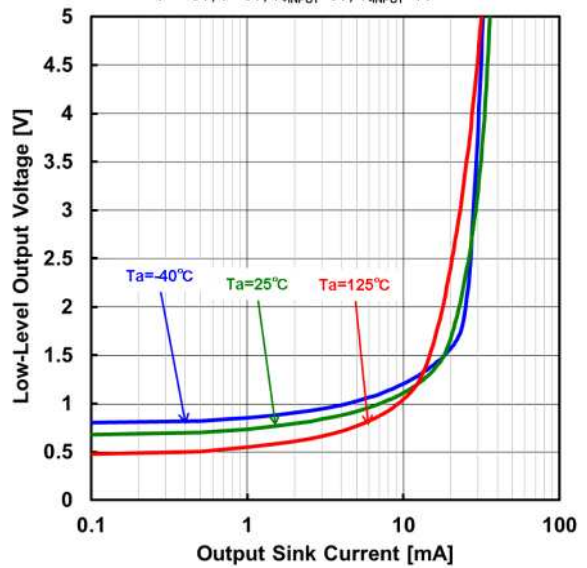

ELECTRICAL CHARACTERISTICS

Open-Loop Voltage gain vs. Ambient Temperature

$R_L=2k\Omega$ to $0V$

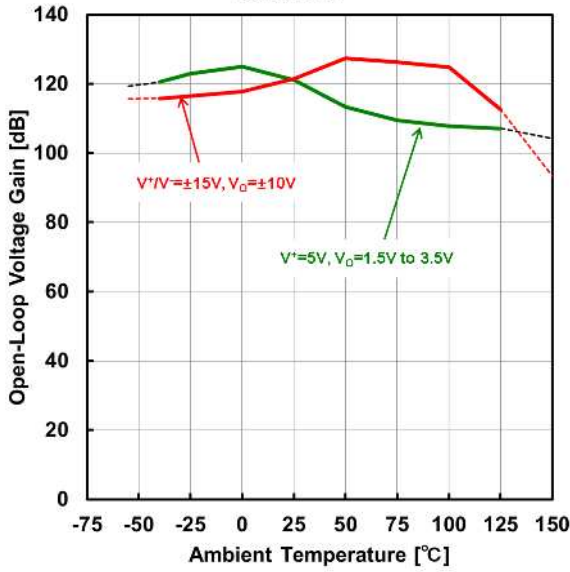

40dB Voltage Gain / Phase vs. Frequency

$V^*V=\pm 15V, G_V=40dB, R_F=100k\Omega, R_L=2k\Omega$ to $0V, C_L=27pF$

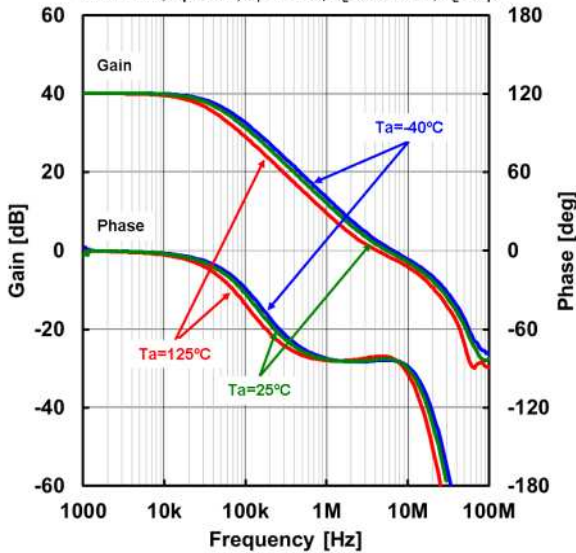

40dB Voltage Gain / Phase vs. Frequency

$V^*=+5V, G_V=40dB, R_F=100k\Omega, R_L=2k\Omega$ to $0V, C_L=27pF$

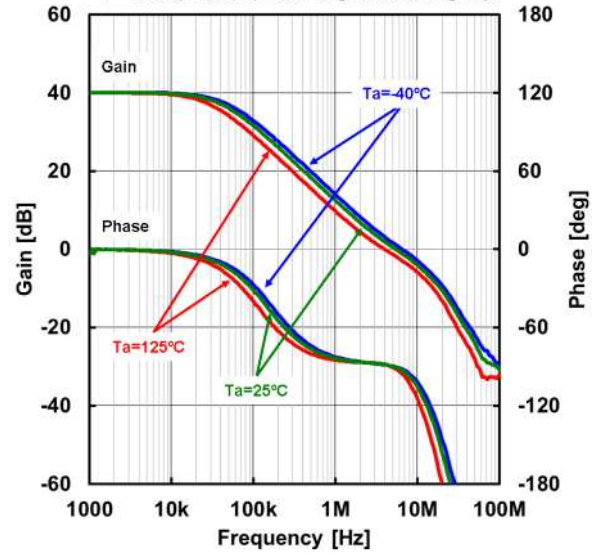

40dB Voltage Gain / Phase vs. Frequency

$V^*V=\pm 15V, G_V=40dB, R_F=100k\Omega, R_L=2k\Omega$ to $0V, Ta=25^\circ C$

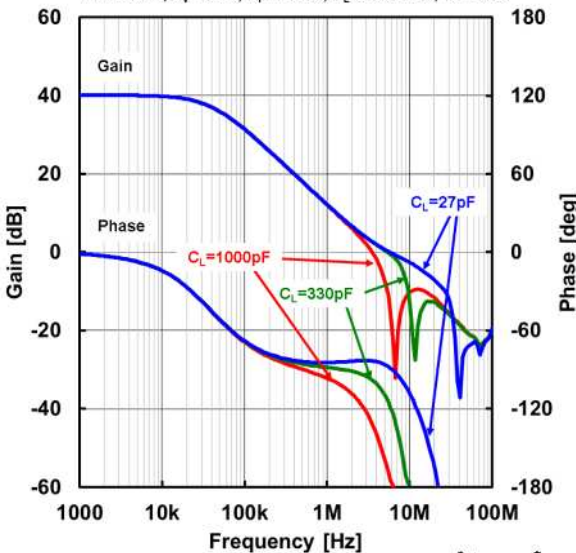

40dB Voltage Gain / Phase vs. Frequency

$V^*=+5V, G_V=40dB, R_F=100k\Omega, R_L=2k\Omega$ to $0V, Ta=25^\circ C$

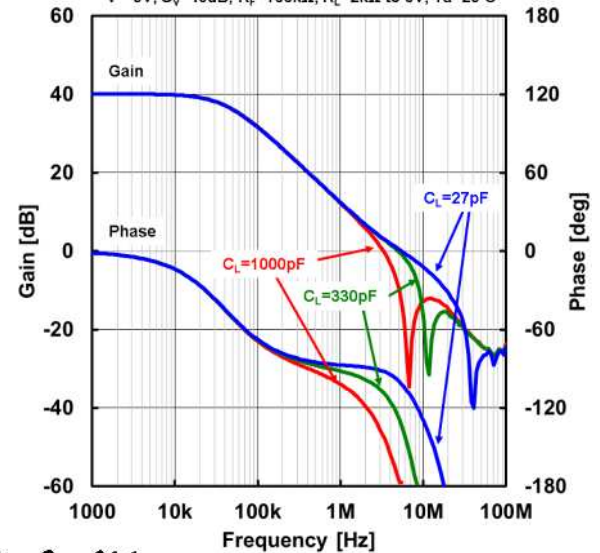

■ ELECTRICAL CHARACTERISTICS

Gain Band Width vs. Ambient Temperature

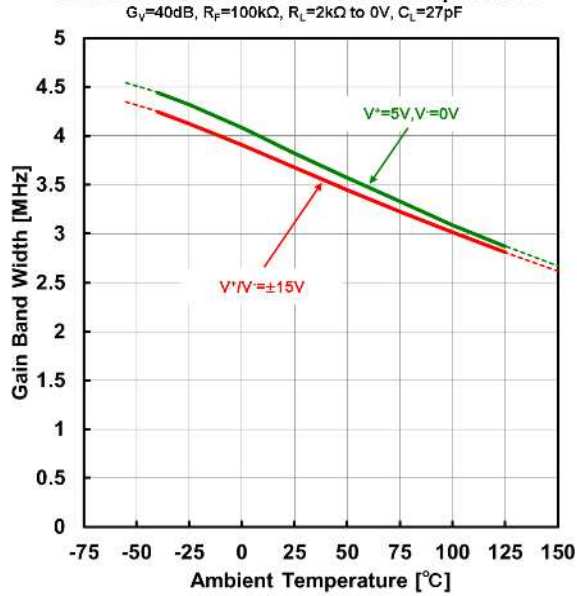

Phase Margin / Gain Margin vs. Ambient Temperature

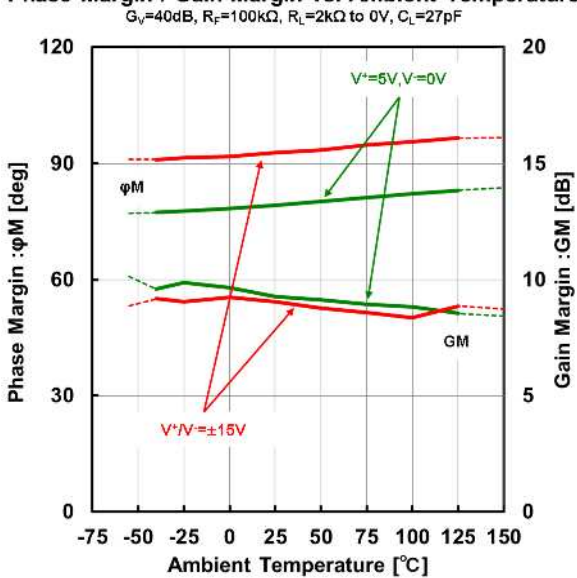

Phase Margin / Gain Margin vs. Load Capacitance

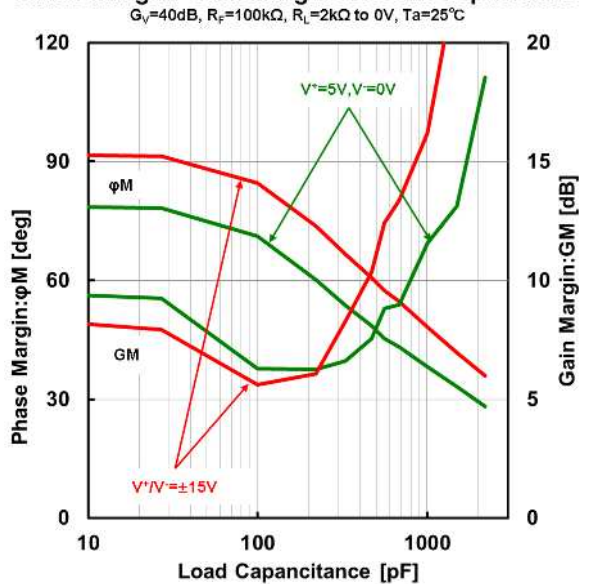

Slew Rate vs. Ambient Temperature

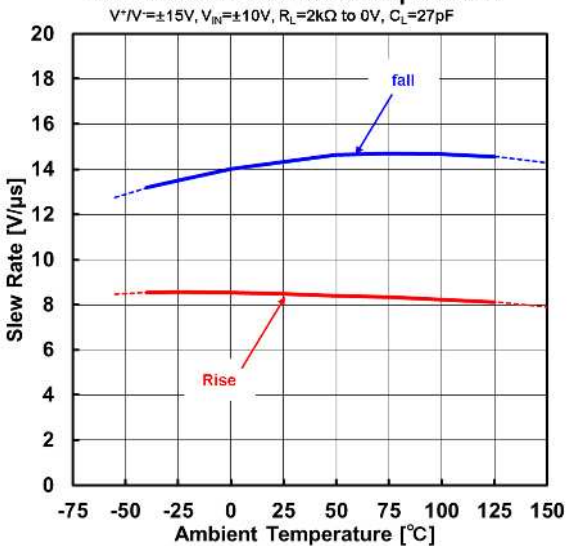

Slew Rate vs. Ambient Temperature

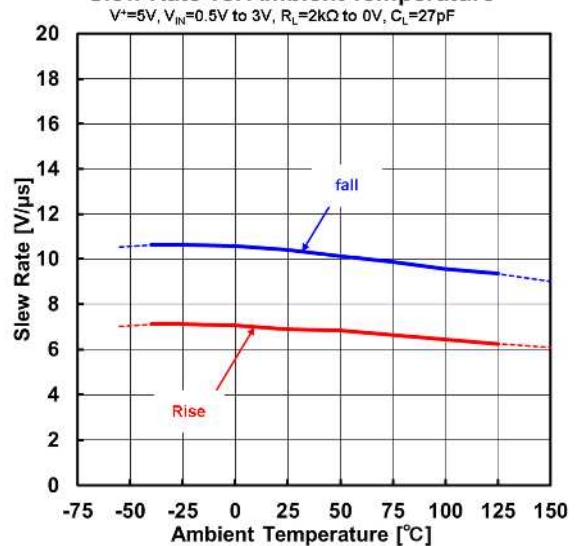

ELECTRICAL CHARACTERISTICS

Pulse Response

$V^+ / V^- = \pm 15V$, $V_{IN} = -10V$ to $+10V$, $G_v = 0dB$, $R_L = 10k\Omega$ to $0V$, $C_L = 27pF$

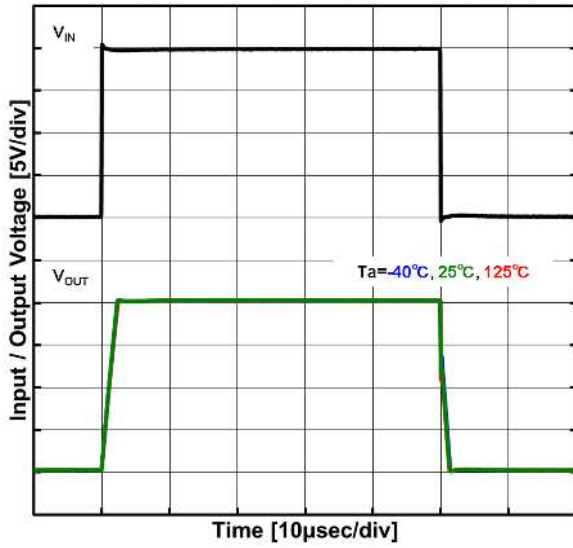

Pulse Response

$V^+ = 5V$, $V_{IN} = 0.5V$ to $3V$, $G_v = 0dB$, $R_L = 2k\Omega$ to $0V$, $C_L = 27pF$

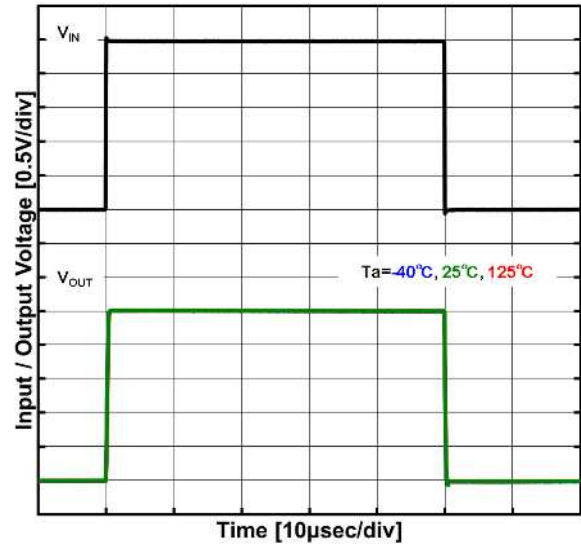

Pulse Response

$V^+ = \pm 15V$, $V_{IN} = -10V$ to $+10V$, $G_v = 0dB$, $R_L = 10k\Omega$ to $0V$, $T_a = 25^\circ C$

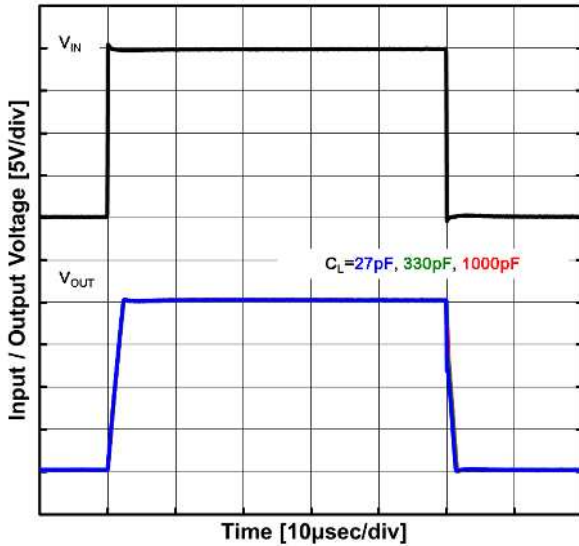

Pulse Response

$V^+ = 5V$, $V_{IN} = 0.5V$ to $3V$, $G_v = 0dB$, $R_L = 2k\Omega$ to $0V$, $T_a = 25^\circ C$

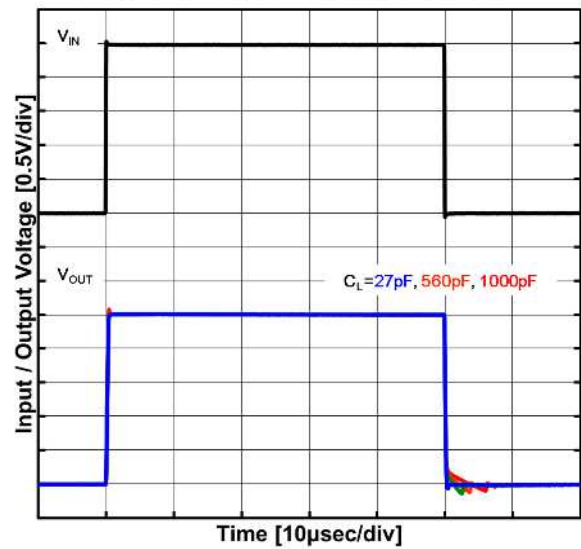

Voltage Noise Density vs. Frequency

$V^+ / V^- = \pm 15V$, $G_v = 40dB$, $R_s = 20\Omega$, $R_L = \infty$, $T_a = 25^\circ C$

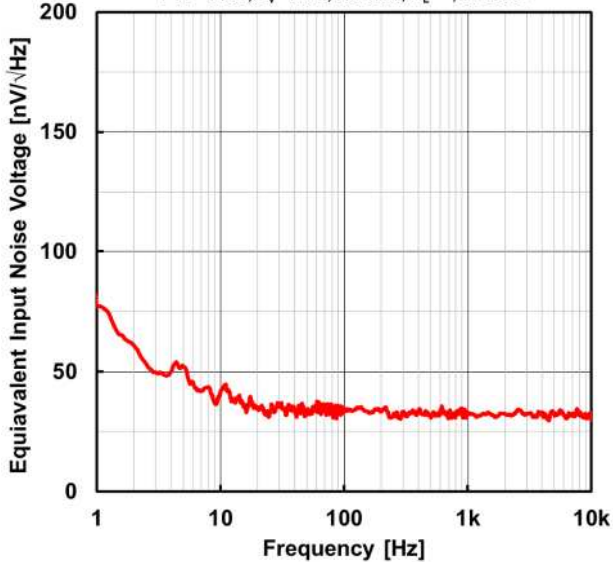

THD + N vs. Output Voltage

$V^+ / V^- = \pm 15V$, $G_v = 20dB$, $R_L = 2k\Omega$ to $0V$, $C_L = 27pF$, $T_a = 25^\circ C$

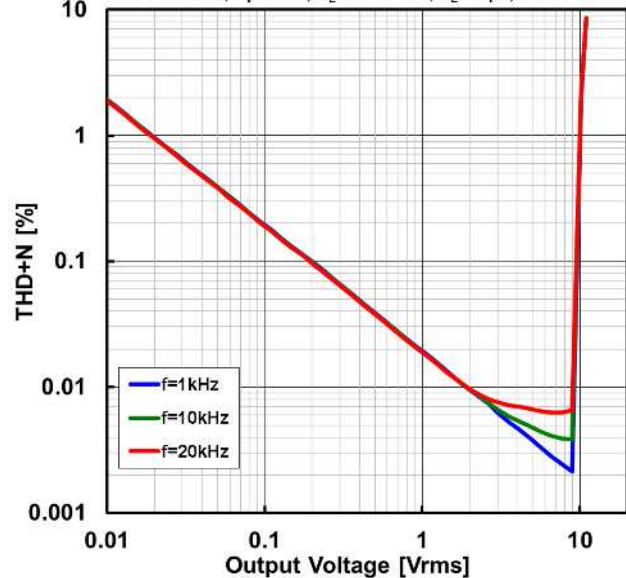

■ PACKAGE DIMENSIONS

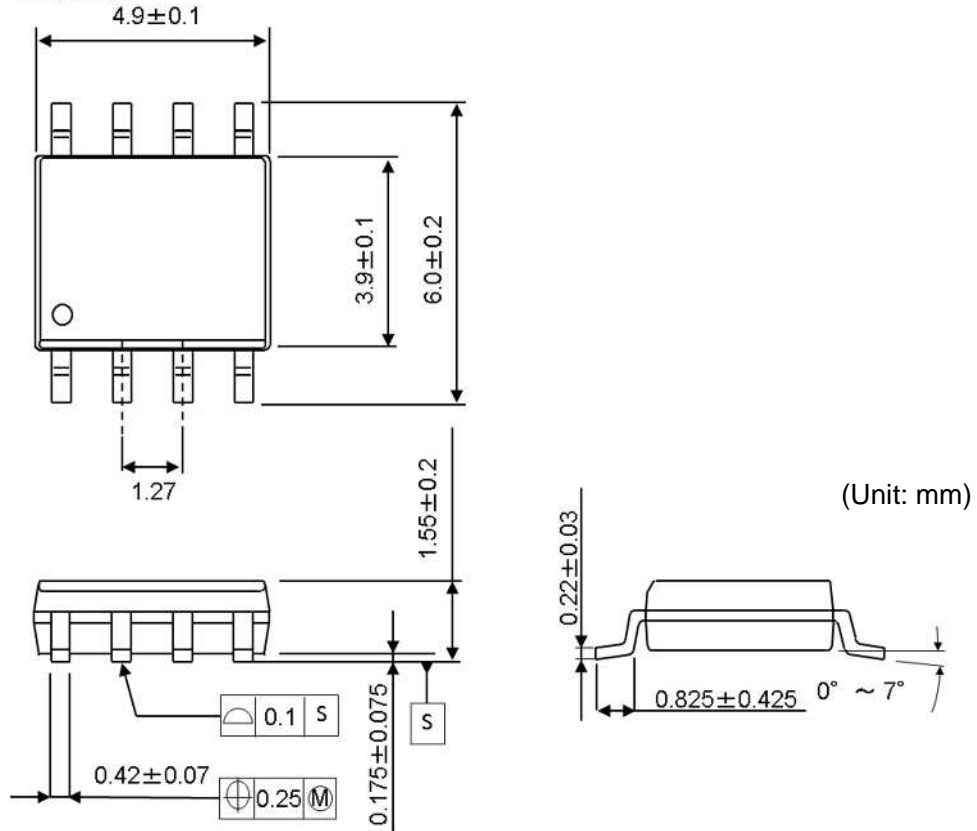

SOP8 Package

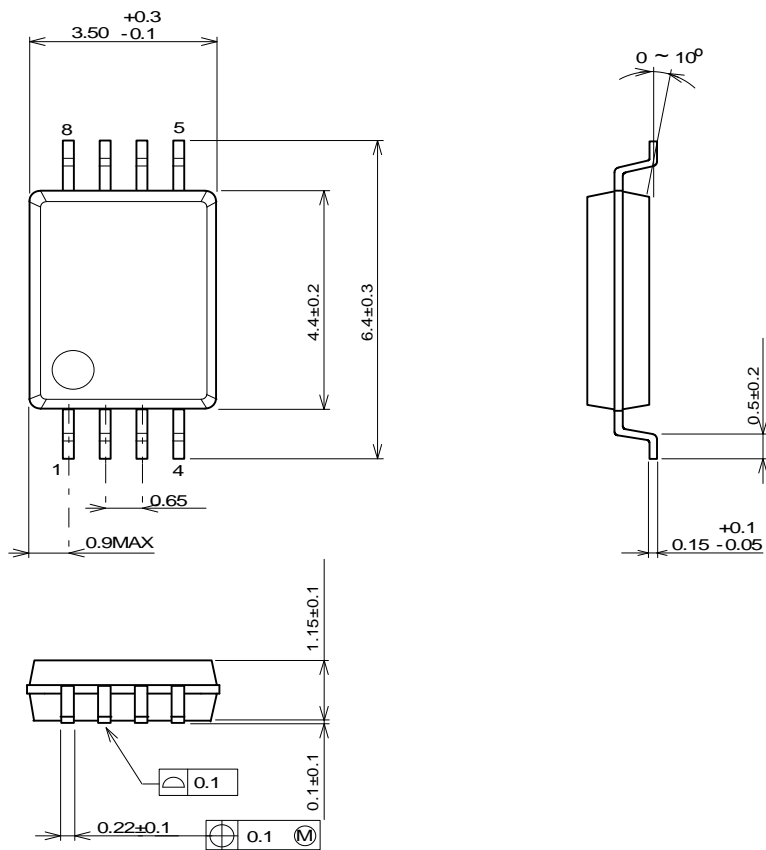

SSOP8 Package

PACKAGE DIMENSIONS

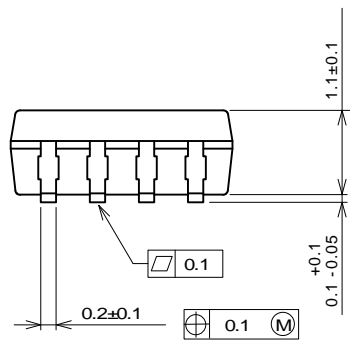
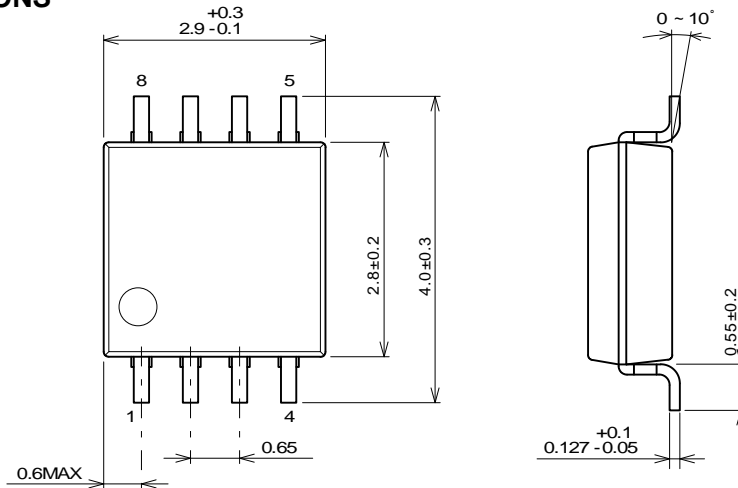

(Unit: mm)

MSOP8 (VSP8) JEDEC MO-187-DA / thin type Package

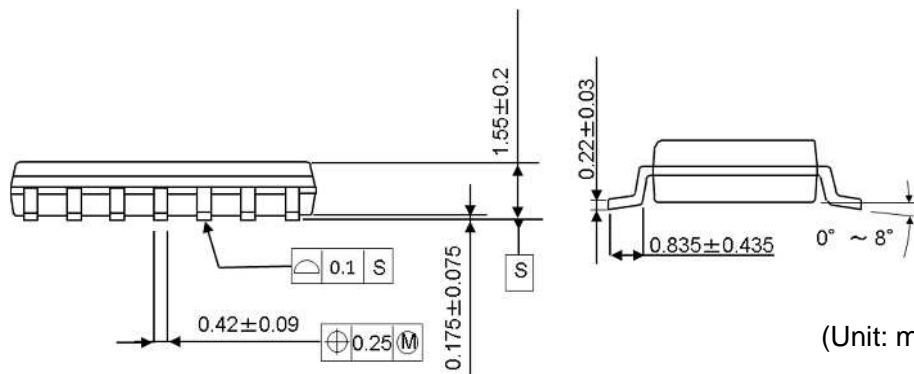
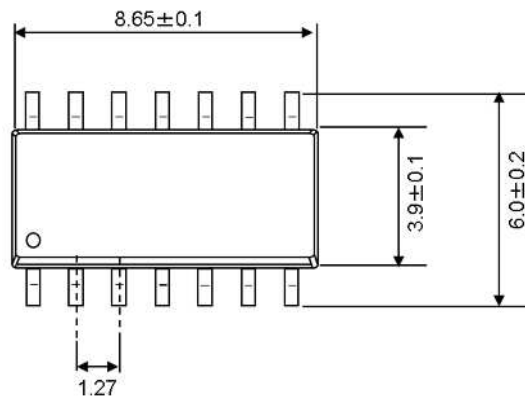

(Unit: mm)

SOP14 Package

■ PACKAGE DIMENSIONS

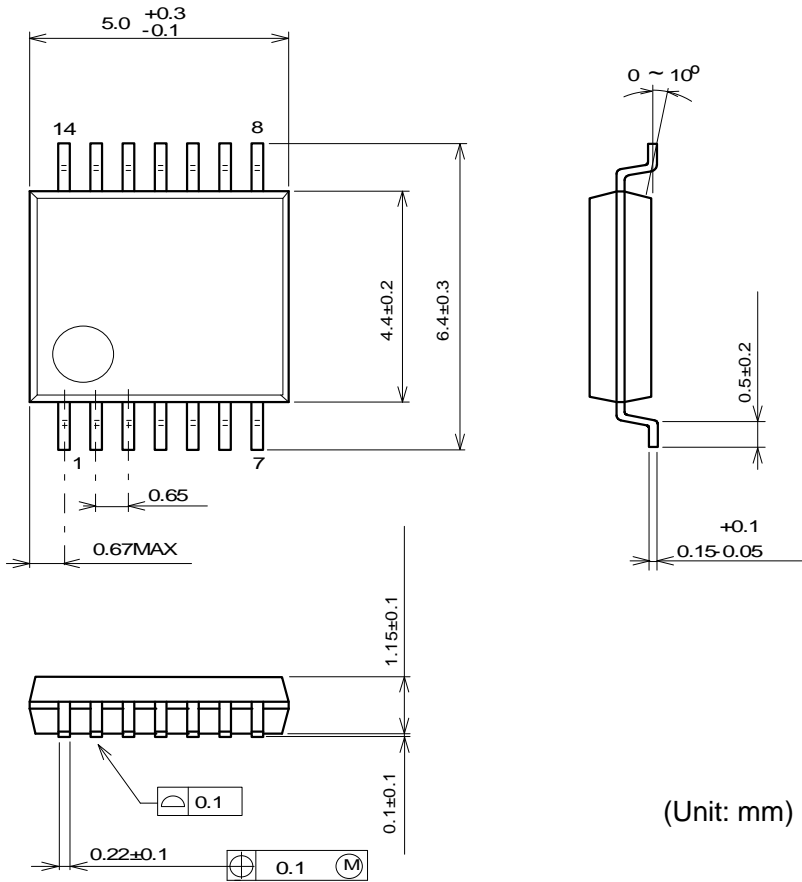

(Unit: mm)

SSOP14 Package

[CAUTION]
 The specifications on this data book are only given for information, without any guarantee as regards either mistakes or omissions. The application circuits in this data book are described only to show representative usages of the product and not intended for the guarantee or permission of any right including the industrial rights.