



## NJM5532C

### LOW-NOISE DUAL OPERATIONAL AMPLIFIER

#### FEATURES

- Equivalent Input Noise Voltage 5nV/ $\sqrt{\text{Hz}}$  typ. at 1kHz
- Gain bandwidth product 10MHz typ.
- Common-Mode Rejection Ratio 100dB typ.
- High DC Voltage Gain 94dB typ.
- High Slew Rate 9V/ $\mu\text{s}$  typ.
- Wide power supply range  $\pm 3\text{V}$  to  $\pm 22\text{V}$
- Internal ESD protection
- Human body model (HBM)  $\pm 2000\text{V}$  typ.

#### DESCRIPTION

The NJM5532C is a high performance dual low noise operational amplifier. This features low noise performance (5nV/ $\sqrt{\text{Hz}}$ ), and considerably higher Gain Band Width (10MHz), low distortion (0.0003%). This makes the device especially suitable for application in high quality and professional audio.

#### APPLICATIONS

- Audio Pre-Amplifier
- Microphon Amplifier
- Line Amplifier
- Industrial

#### EQUIVALENT CIRCUIT (Each Amplifier)

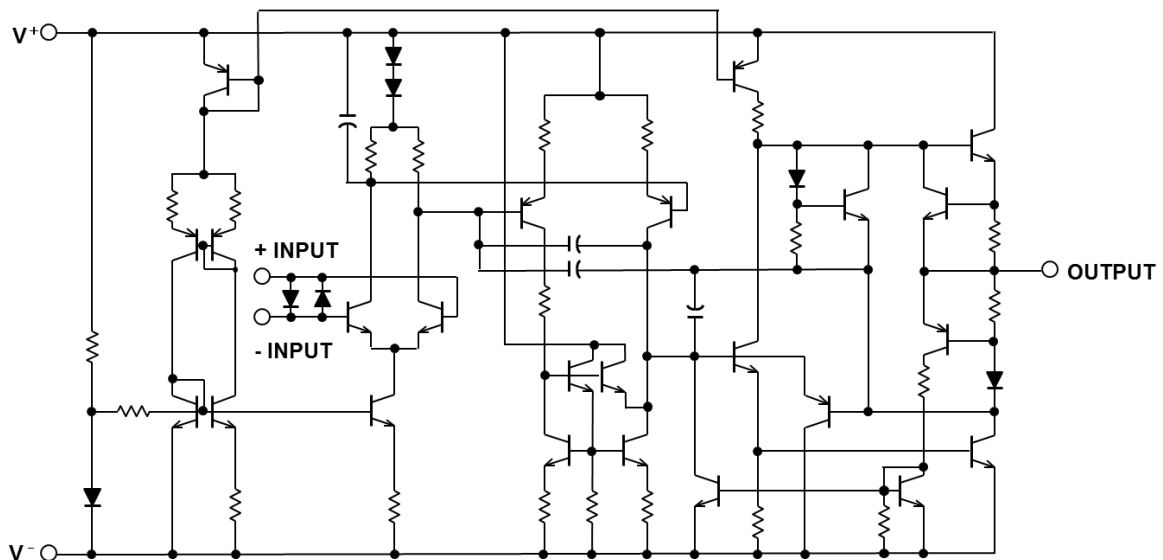

■ PRODUCT NAME INFORMATION

NJM5532C G (TE2)

Description of configuration

Suffix	Parameter	Description
G	Package code	Indicates the package. Refer to the order information.
TE2	Packing	Refer to the packing specifications.

■ ORDER INFORMATION

Product Name	Package	RoHS	Halogen-Free	Terminal Finish	Marking	Weight (mg)	MOQ (pcs)
NJM5532CG (TE2)	SOP8	Yes	Yes	Pure Sn	5532C	88	2500

■ PIN DESCRIPTIONS

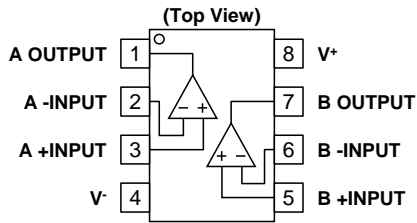

Pin No. SOP8	SYMBOL	I/O	DESCRIPTION
1	A OUTPUT	O	Output channel A
2	A -INPUT	I	Inverting input channel A
3	A +INPUT	I	Non-inverting input channel A
7	BOUTPUT	O	Output channel B
6	B -INPUT	I	Inverting input channel B
5	B +INPUT	I	Non-inverting input channel B
8	V+	-	Positive supply
4	V-	-	Negative supply or Ground (single supply)

■ ABSOLUTE MAXIMUM RATINGS

Parameter	Symbol	Rating	Unit
Supply voltage	V <sup>+</sup> / V <sup>-</sup>	±22	V
Input voltage <sup>*1</sup>	V <sub>IN</sub>	V <sup>-</sup> - 0.3 to V <sup>-</sup> +44	V
Output terminal input voltage	V <sub>O</sub>	V <sup>-</sup> - 0.3 to V <sup>+</sup> + 0.3	V
Differential input voltage <sup>*2</sup>	V <sub>ID</sub>	±0.5	V
Input current <sup>*3</sup>	I <sub>IN</sub>	±10	mA
Output short-circuit duration <sup>*4</sup>		Infinite	-
Power Dissipation	P <sub>D</sub>	690 <sup>*5</sup> 1000 <sup>*6</sup>	mW
Storage temperature range	T <sub>stg</sub>	-65 to 150	°C

- <sup>\*1</sup> Input voltage is the voltage should be allowed to apply to the input terminal independent of the magnitude of V<sup>+</sup>. The normal operation will establish when any input is within the Common Mode Input Voltage Range of electrical characteristics.
- <sup>\*2</sup> Differential voltage is the voltage difference between +INPUT and -INPUT.
- <sup>\*3</sup> Excessive input current will flow if a differential input voltage in excess of approximately 0.5 V is applied between the inputs, unless some limiting resistance is used.
- <sup>\*4</sup> The output may be shorted to ground or either power supply. Temperature and/or supply voltages must be limited to ensure the maximum dissipation rating is not exceeded.
- <sup>\*5</sup> EIA/JEDEC STANDARD Test board (76.2 x 114.3 x 1.6mm, 2layers, FR-4) mounting
- <sup>\*6</sup> EIA/JEDEC STANDARD Test board (76.2 x 114.3 x 1.6mm, 4layers, FR-4) mounting

ABSOLUTE MAXIMUM RATINGS
Electronic and mechanical stress momentarily exceeded absolute maximum ratings may cause permanent damage and may degrade the lifetime and safety for both device and system using the device in the field. The functional operation at or over these absolute maximum ratings is not assured.

■ THERMAL CHARACTERISTICS

Package	Measurement Result		Unit
	Thermal Resistance (θ <sub>ja</sub> )	Thermal Characterization Parameter (ψ <sub>jt</sub> )	
SOP8	181 <sup>*1</sup> / 125 <sup>*2</sup>	49 <sup>*1</sup> / 43 <sup>*2</sup>	°C/W

- q<sub>ja</sub>:Junction-to-Ambient Thermal Resistance
- ψ<sub>jt</sub>:Junction-to-Top Thermal Characterization Parameter
- <sup>\*1</sup> EIA/JEDEC STANDARD Test board (76.2 x 114.3 x 1.6mm, 2layers, FR-4) mounting
- <sup>\*2</sup> EIA/JEDEC STANDARD Test board (76.2 x 114.3 x 1.6mm, 4layers, FR-4) mounting

■ ELECTROSTATIC DISCHARGE (ESD) PROTECTION VOLTAGE

Parameter	Conditions	Protection Voltage
HBM	C = 100 pF, R = 1.5 kΩ	±2000 V
CDM	Direct CDM	±1000 V

ELECTROSTATIC DISCHARGE RATINGS
The electrostatic discharge test is done based on JEITA ED-4701. In the HBM method, ESD is applied using the power supply pin and GND pin as reference pins.

#### ■ RECOMMENDED OPERATING CONDITIONS

Parameter	Symbol	Conditions	Rating	Unit
Supply Voltage	$V^+ / V^-$		$\pm 3$ to $\pm 22$	V
Operating Temperature	$T_a$		-40 to 85	°C

#### RECOMMENDED OPERATING CONDITIONS

All of electronic equipment should be designed that the mounted semiconductor devices operate within the recommended operating conditions. The semiconductor devices cannot operate normally over the recommended operating conditions, even if when they are used over such conditions by momentary electronic noise or surge. And the semiconductor devices may receive serious damage when they continue to operate over the recommended operating conditions.

■ ELECTRICAL CHARACTERISTICS

$V^+ / V^- = \pm 15V$ ,  $T_a = 25^\circ C$ , unless otherwise specified.

Parameter	Symbol	Test Conditions	Min	Typ	Max	Unit
Input Offset Voltage *1	$V_{IO}$	$R_S = 50\Omega$ $T_a = 25^\circ C$ $0^\circ C < T_a < 70^\circ C$ *2	-	0.5	4	mV
			-	-	5	mV
Input Offset Current *1	$I_{IO}$	$T_a = 25^\circ C$ $0^\circ C < T_a < 70^\circ C$ *2	-	10	150	nA
			-	-	200	nA
Input Bias Current *1	$I_B$	$T_a = 25^\circ C$ $0^\circ C < T_a < 70^\circ C$ *2	-	200	800	nA
			-	-	1000	nA
Open-Loop Voltage Gain1	$A_{V1}$	$R_L \geq 600\Omega$ , $V_O = \pm 10V$ $T_a = 25^\circ C$ $0^\circ C < T_a < 70^\circ C$ *2	83.5	94	-	dB
			80	-	-	dB
Open-Loop Voltage Gain2	$A_{V2}$	$R_L \geq 2k\Omega$ , $V_O = \pm 10V$ $T_a = 25^\circ C$ $0^\circ C < T_a < 70^\circ C$ *2	88	100	-	dB
			83.5	-	-	dB
Supply Voltage Rejection Ratio	SVR	$R_S \leq 10k\Omega$ , $V^+ / V^- = \pm 9V$ to $\pm 15V$	80	100	-	dB
Supply Current (All Amplifiers)	$I_{SUPPLY}$	No Signal	-	8	16	mA
Common-Mode Input Voltage Range	$V_{ICM}$		$\pm 12$	$\pm 13$	-	V
Common-Mode Rejection Ratio	CMR	$R_S \leq 10k\Omega$	70	100	-	dB
Output Short-Circuit Current*3	$I_{SC}$		20	50	75	mA
Maximum Output Voltage	$V_{OM}$	$R_L \geq 600\Omega$ $R_L \geq 600\Omega$ , $V^+ / V^- = \pm 18V$	$\pm 12$	$\pm 13$	-	V
			$\pm 15$	$\pm 16$	-	V
Input Resistance	$R_{IN}$		30	150	-	k $\Omega$
Output Resistance	$R_O$		-	0.3	-	$\Omega$
Small-signal Voltage Gain	$A_V$	$f = 10kHz$	-	67	-	dB
Gain Bandwidth Product	GBW	$R_L = 600\Omega$ , $C_L = 100pF$	-	10	-	MHz
Powerband Width	WPG	$R_L = 600\Omega$ , $V_O = \pm 10V$ $R_L = 600\Omega$ , $V_O = \pm 14V$ , $V^+ / V^- = \pm 18V$	-	140	-	kHz
			-	100	-	kHz
Equivalent Input Noise Voltage1	$e_n$	$f = 30Hz$ $f = 1kHz$	-	8	-	nV/ $\sqrt{Hz}$
			-	5	-	nV/ $\sqrt{Hz}$
Equivalent Input Noise Current	$I_n$	$f = 30Hz$ $f = 1kHz$	-	2.7	-	pA/ $\sqrt{Hz}$
			-	0.7	-	pA/ $\sqrt{Hz}$
Equivalent Input Noise Voltage2	$V_{NI}$	$f = 20Hz$ to $20kHz$	-	0.6	0.8	$\mu V_{rms}$
Slew Rate	SR		-	9	-	V/ $\mu s$
Overshoot	$K_{OV}$	$G_V = 1$ , $V_{IN} = 100mV_{PP}$ , $C_L = 100pF$ , $R_L = 600\Omega$	-	10	-	%
Channel Separation	CS	$f = 1kHz$	-	110	-	dB

\*1 Absolute values.

\*2 These parameters are not 100% test.

\*3 Temperature and /or supply voltages must be limited to ensure the maximum dissipation rating is not exceeded.

■ APPLICATION INFORMATION

• Back-to-back Diode Protection

The input terminals of the NJM5532C are protected from excessive differential voltage by back-to-back diodes. However, When used in voltage follower circuit, the back-to-back diode may break at power on. Therefore, put a current-limiting resistance to input terminal as shown Fig.1.

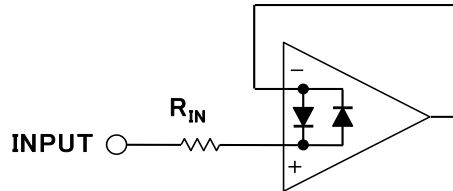

Fig. 1

• Caution to Thermal Design

If the NJM5532C junction temperature ( $T_j$ ) exceeds  $150^{\circ}\text{C}$  and the package power dissipation ( $P_D$ ), there is possibility of the NJM5532C deterioration or breakdown.

The NJM5532C supply current is higher ( $I_{CCMax} = 16\text{mA}$  at  $V^+ / V^- = \pm 15\text{V}$ ,  $T_a = 25^{\circ}\text{C}$ ) and has positive temperature coefficient (Refer to Supply Current vs. Temperature characteristic).

Therefore, you should carefully design with due attention to the supply voltage, the internal power dissipation and the ambient temperature.

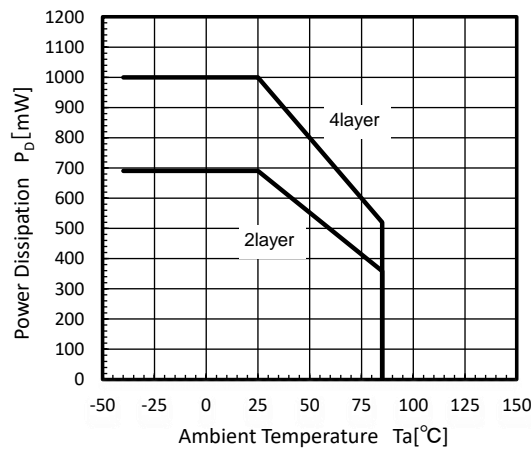

• Countermeasure to Excess Current by Parasitic Circuit

When the NJM5532C V+ is OPEN (Fig.2), the NJM5532C may be burnt flowing the excess current by internal parasitic circuit (Fig.3). The excess current generating condition is following:

- / Between input terminal and V- voltage difference is higher.
- / Between input terminal and GND impedance is small.
- / V+ terminal is connected with low impedance. (I<sub>etc</sub> is higher)

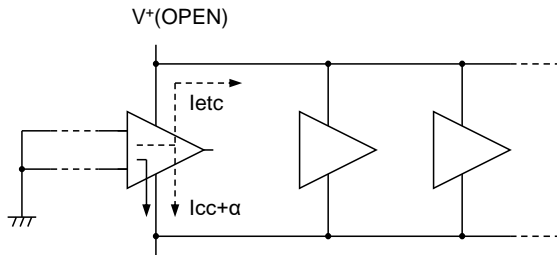

Fig. 2

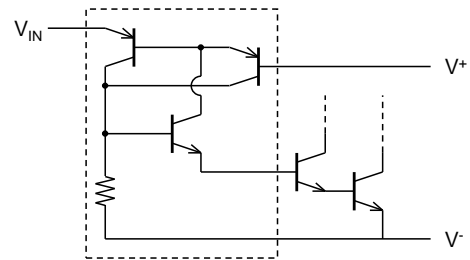

Fig. 3

For countermeasure to excess current by parasitic circuit, NJRC recommends the following method.

- / prevent operating of a parasitic circuit by inserting a diode (Fig.4-1 / 4-2).
- / limiting a parasitic circuit operation by inserting a resistance (1kΩ or more) (Fig.5).

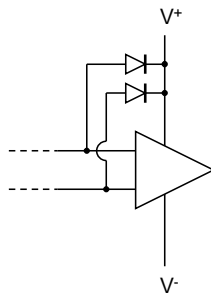

Fig. 4-1

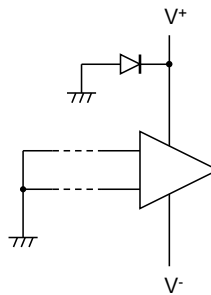

Fig. 4-1

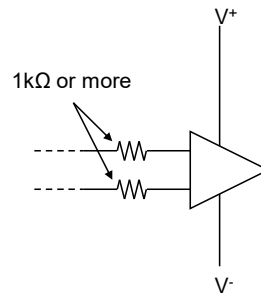
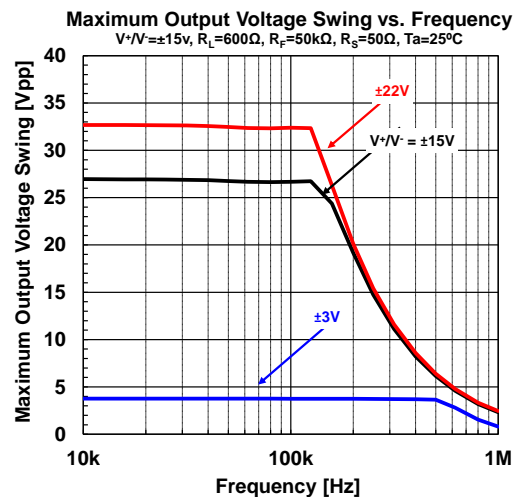
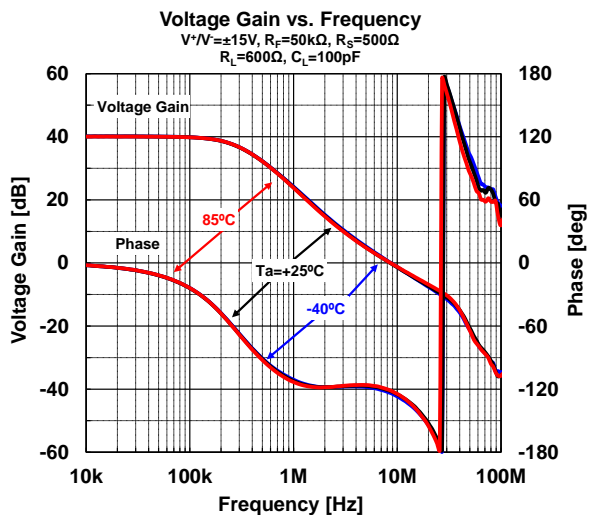
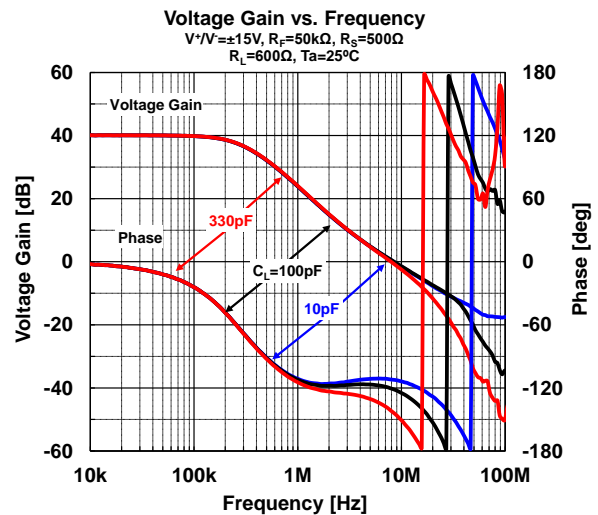
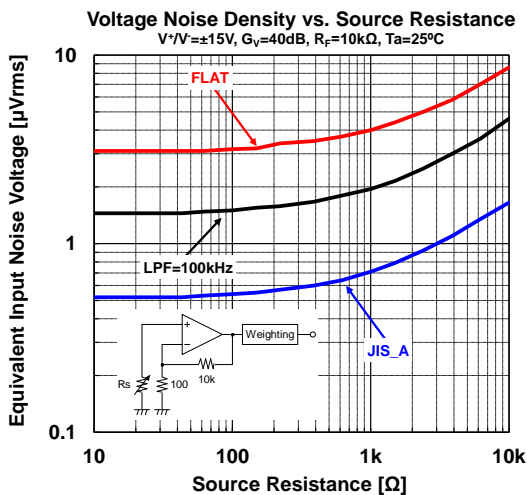
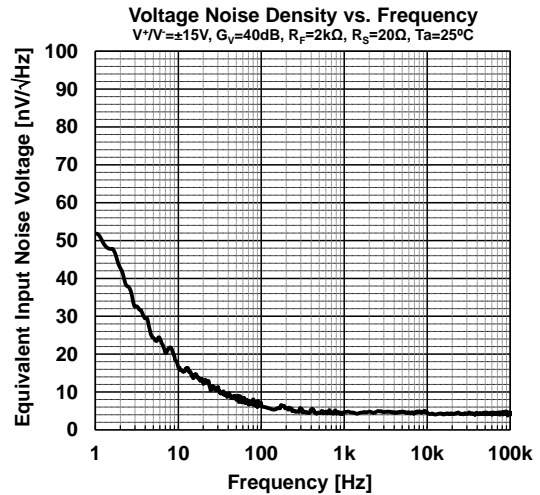
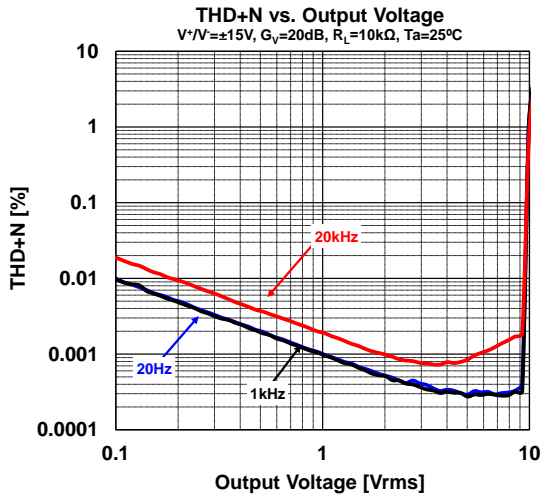

Fig. 5



■ TYPICAL CHARACTERISTICS

Note: Typical Characteristics are intended to be used as reference data; they are not guaranteed.



■ TYPICAL CHARACTERISTICS

Note: Typical Characteristics are intended to be used as reference data; they are not guaranteed.

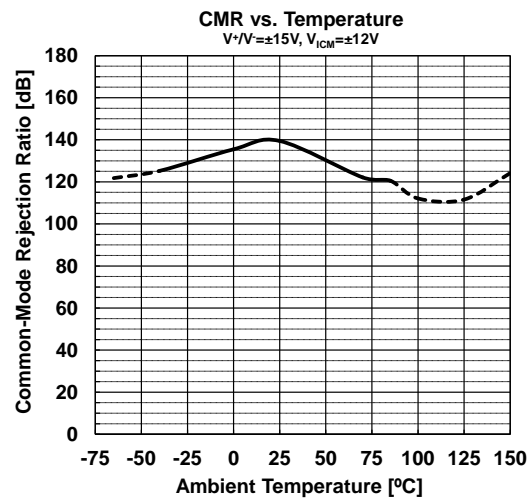
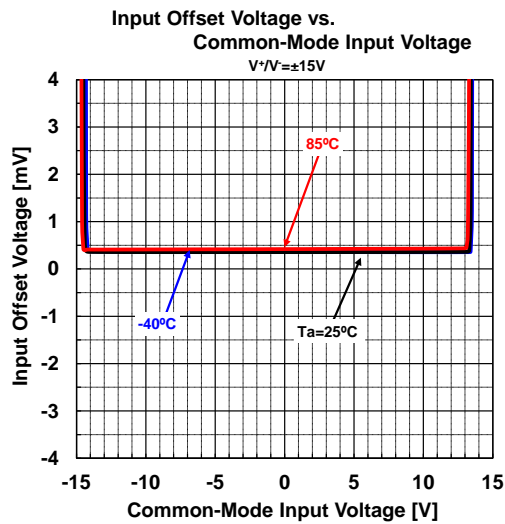
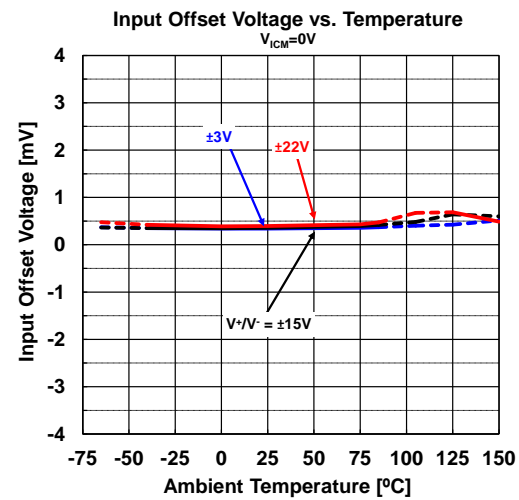
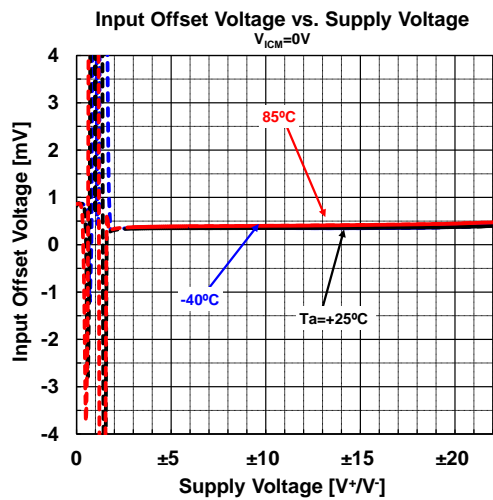
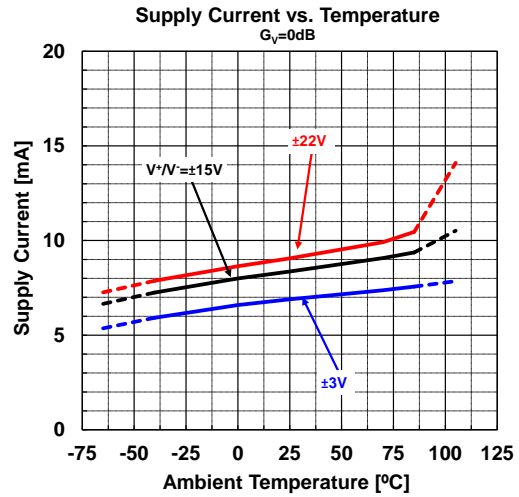
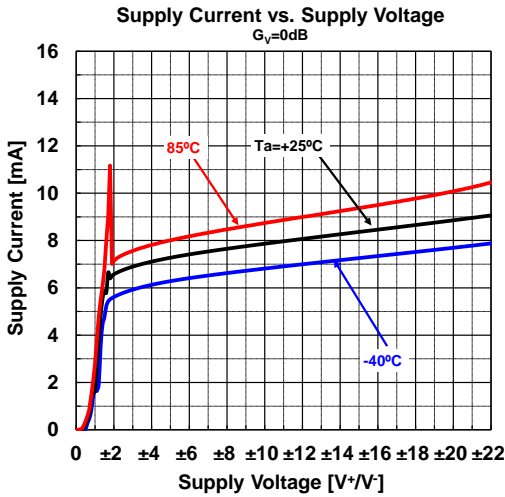

■ TYPICAL CHARACTERISTICS

Note: Typical Characteristics are intended to be used as reference data; they are not guaranteed.

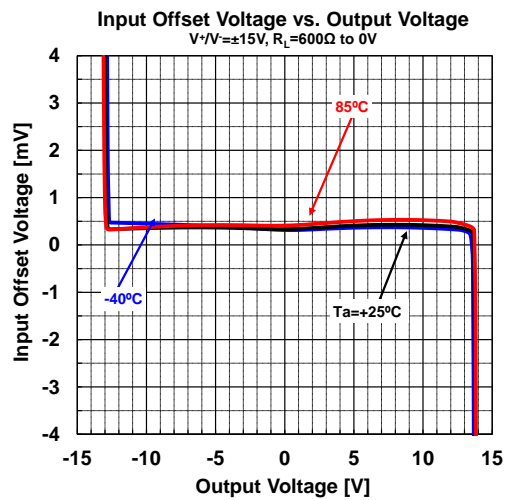
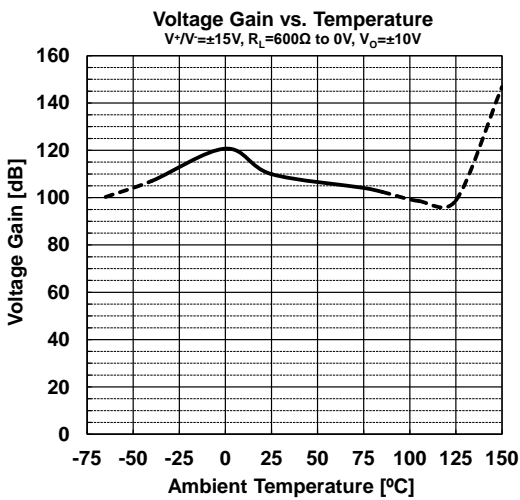
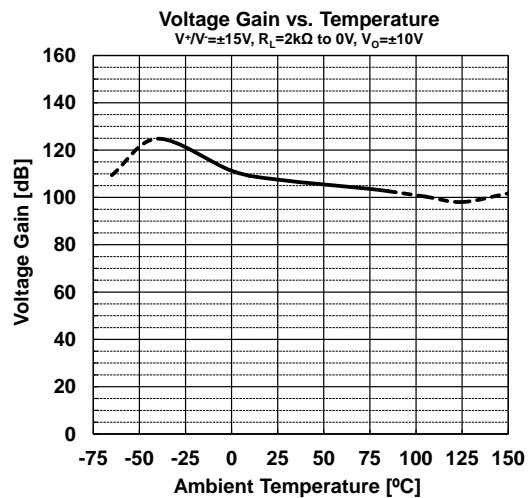
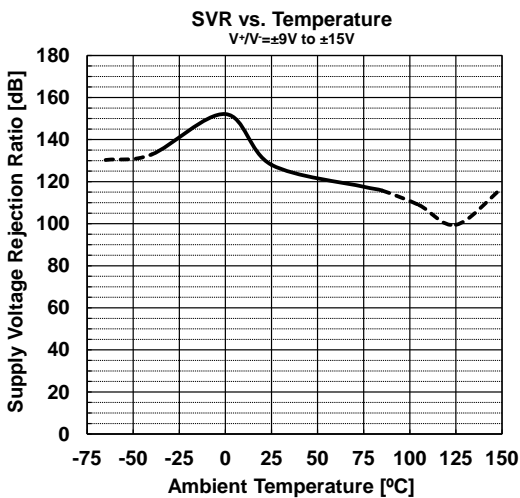
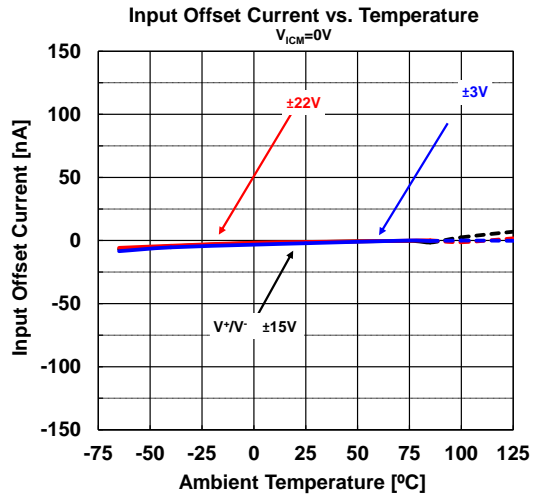
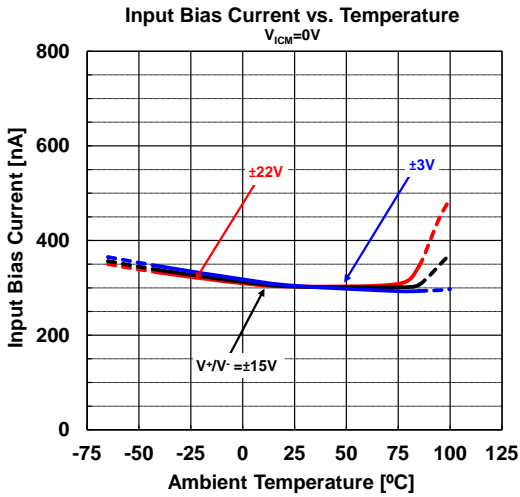

■ TYPICAL CHARACTERISTICS

Note: Typical Characteristics are intended to be used as reference data; they are not guaranteed.

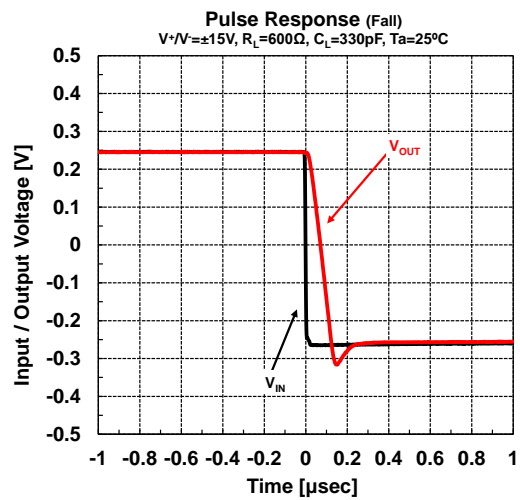
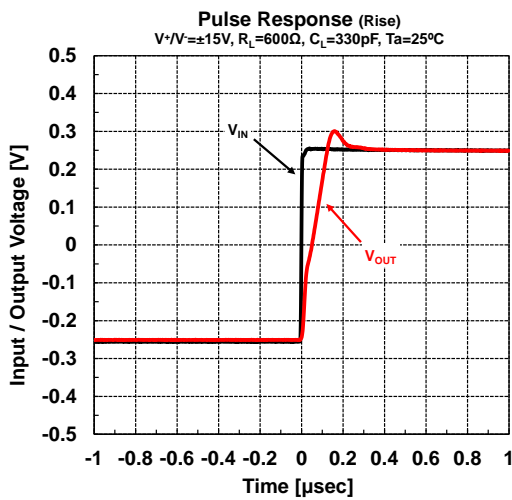
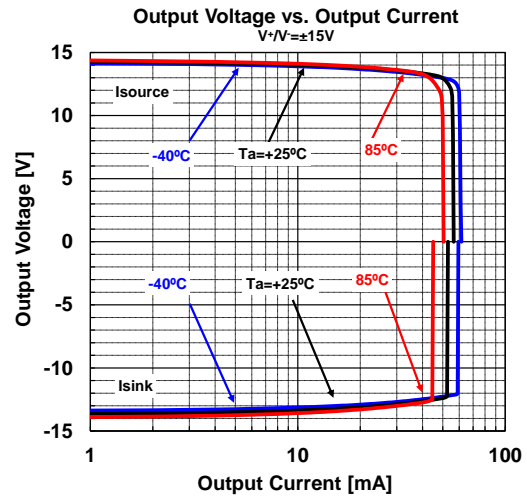
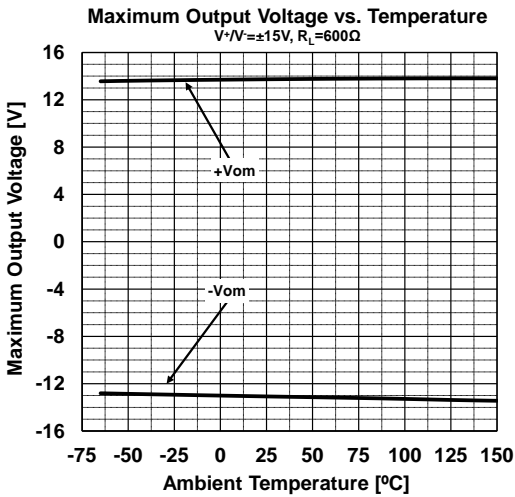
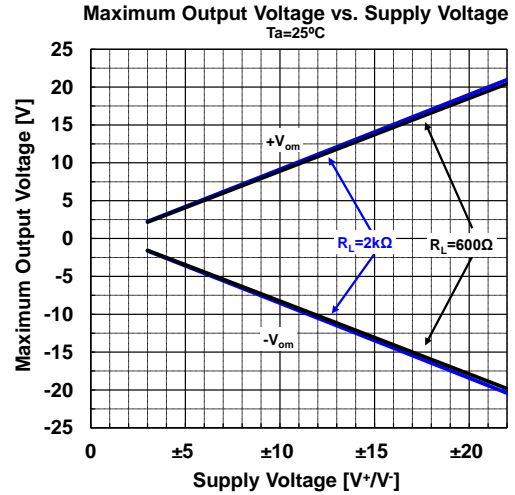
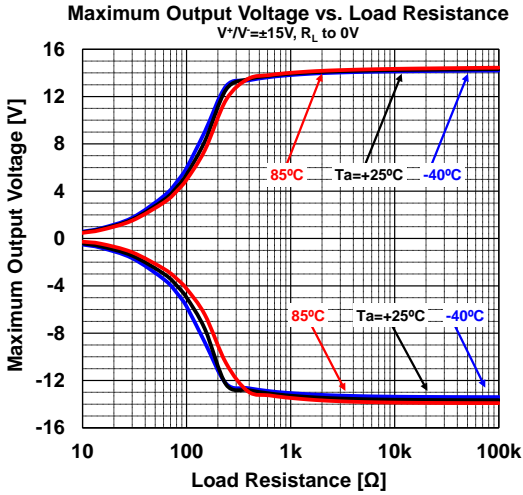

■ TYPICAL CHARACTERISTICS

Note: Typical Characteristics are intended to be used as reference data; they are not guaranteed.

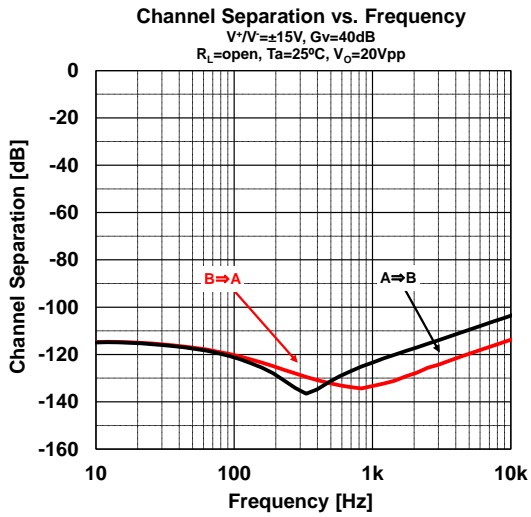

■ REVISION HISTORY

Date	Revision	Changes
September 5, 2022	Ver.1.0	Changed data sheet format.



## ■ EXAMPLE OF SOLDER PADS DIMENSIONS

UNIT: mm

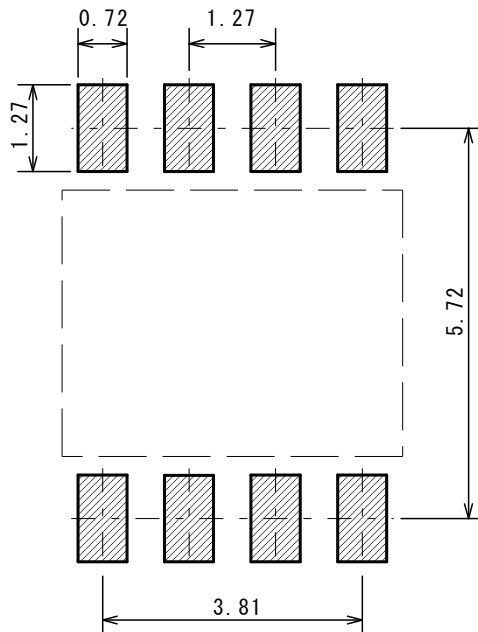



# Nisshinbo Micro Devices Inc.

SOP8

PI-SOP8-E-A

■ PACKING SPEC

UNIT: mm

REEL DIMENSIONS / TAPING DIMENSIONS

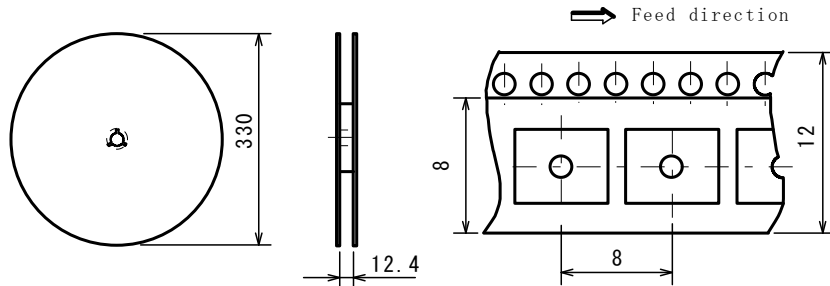

TAPING STATE

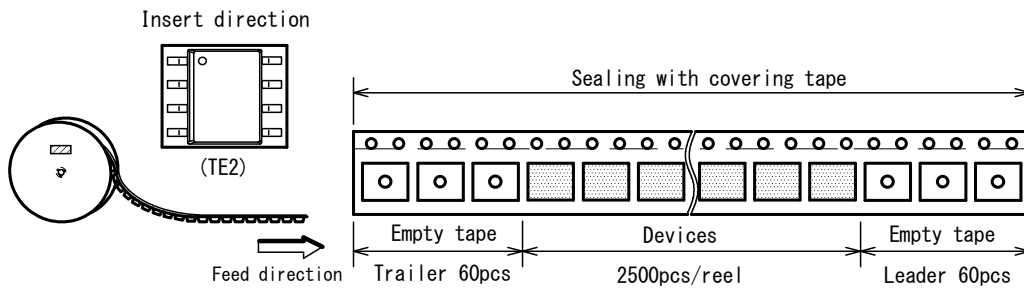

PACKING STATE

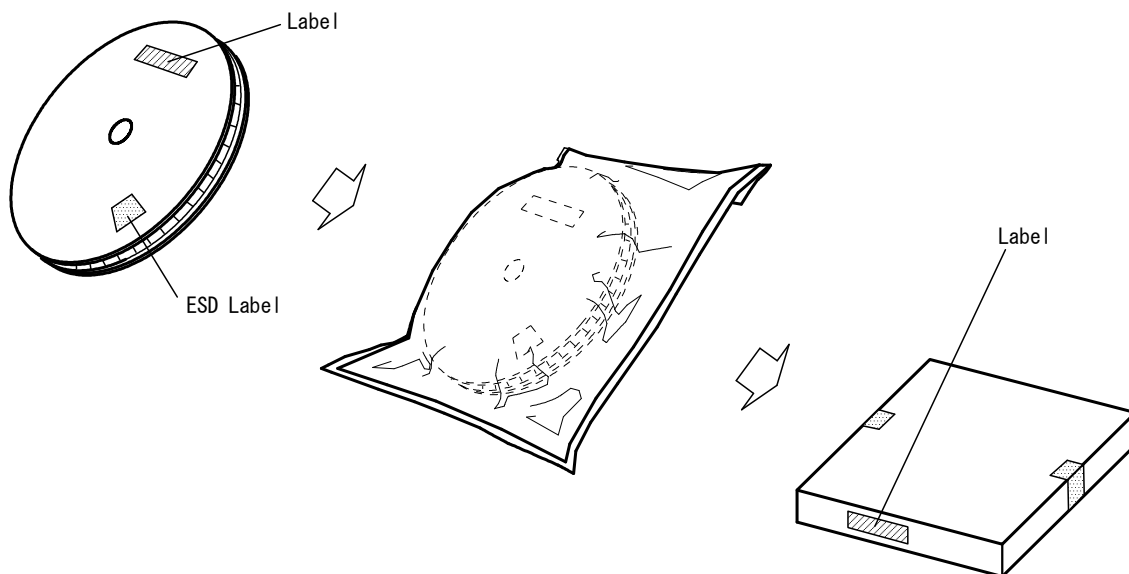

1. The products and the product specifications described in this document are subject to change or discontinuation of production without notice for reasons such as improvement. Therefore, before deciding to use the products, please refer to our sales representatives for the latest information thereon.
2. The materials in this document may not be copied or otherwise reproduced in whole or in part without the prior written consent of us.
3. This product and any technical information relating thereto are subject to complementary export controls (so-called KNOW controls) under the Foreign Exchange and Foreign Trade Law, and related politics ministerial ordinance of the law. (Note that the complementary export controls are inapplicable to any application-specific products, except rockets and pilotless aircraft, that are insusceptible to design or program changes.) Accordingly, when exporting or carrying abroad this product, follow the Foreign Exchange and Foreign Trade Control Law and its related regulations with respect to the complementary export controls.
4. The technical information described in this document shows typical characteristics and example application circuits for the products. The release of such information is not to be construed as a warranty of or a grant of license under our or any third party's intellectual property rights or any other rights.
5. The products listed in this document are intended and designed for use as general electronic components in standard applications (office equipment, telecommunication equipment, measuring instruments, consumer electronic products, amusement equipment etc.). Those customers intending to use a product in an application requiring extreme quality and reliability, for example, in a highly specific application where the failure or misoperation of the product could result in human injury or death should first contact us.
  - Aerospace Equipment
  - Equipment Used in the Deep Sea
  - Power Generator Control Equipment (nuclear, steam, hydraulic, etc.)
  - Life Maintenance Medical Equipment
  - Fire Alarms / Intruder Detectors
  - Vehicle Control Equipment (automotive, airplane, railroad, ship, etc.)
  - Various Safety Devices
  - Traffic control system
  - Combustion equipment

In case your company desires to use this product for any applications other than general electronic equipment mentioned above, make sure to contact our company in advance. Note that the important requirements mentioned in this section are not applicable to cases where operation requirements such as application conditions are confirmed by our company in writing after consultation with your company.

6. We are making our continuous effort to improve the quality and reliability of our products, but semiconductor products are likely to fail with certain probability. In order to prevent any injury to persons or damages to property resulting from such failure, customers should be careful enough to incorporate safety measures in their design, such as redundancy feature, fire containment feature and fail-safe feature. We do not assume any liability or responsibility for any loss or damage arising from misuse or inappropriate use of the products.
7. The products have been designed and tested to function within controlled environmental conditions. Do not use products under conditions that deviate from methods or applications specified in this datasheet. Failure to employ the products in the proper applications can lead to deterioration, destruction or failure of the products. We shall not be responsible for any bodily injury, fires or accident, property damage or any consequential damages resulting from misuse or misapplication of the products.
8. **Quality Warranty**
  - 8-1. **Quality Warranty Period**

In the case of a product purchased through an authorized distributor or directly from us, the warranty period for this product shall be one (1) year after delivery to your company. For defective products that occurred during this period, we will take the quality warranty measures described in section 8-2. However, if there is an agreement on the warranty period in the basic transaction agreement, quality assurance agreement, delivery specifications, etc., it shall be followed.
  - 8-2. **Quality Warranty Remedies**

When it has been proved defective due to manufacturing factors as a result of defect analysis by us, we will either deliver a substitute for the defective product or refund the purchase price of the defective product.

Note that such delivery or refund is sole and exclusive remedies to your company for the defective product.
  - 8-3. **Remedies after Quality Warranty Period**

With respect to any defect of this product found after the quality warranty period, the defect will be analyzed by us. On the basis of the defect analysis results, the scope and amounts of damage shall be determined by mutual agreement of both parties. Then we will deal with upper limit in Section 8-2. This provision is not intended to limit any legal rights of your company.
9. Anti-radiation design is not implemented in the products described in this document.
10. The X-ray exposure can influence functions and characteristics of the products. Confirm the product functions and characteristics in the evaluation stage.
11. WLCSP products should be used in light shielded environments. The light exposure can influence functions and characteristics of the products under operation or storage.
12. Warning for handling Gallium and Arsenic (GaAs) products (Applying to GaAs MMIC, Photo Reflector). These products use Gallium (Ga) and Arsenic (As) which are specified as poisonous chemicals by law. For the prevention of a hazard, do not burn, destroy, or process chemically to make them as gas or power. When the product is disposed of, please follow the related regulation and do not mix this with general industrial waste or household waste.
13. Please contact our sales representatives should you have any questions or comments concerning the products or the technical information.



**Nisshinbo Micro Devices Inc.**

**Official website**

<https://www.nisshinbo-microdevices.co.jp/en/>

**Purchase information**

<https://www.nisshinbo-microdevices.co.jp/en/buy/>