

DC/DC CONVERTER CONTROL IC
WITH CURRENT SENSE AMPLIFIER

■GENERAL DESCRIPTION

The **NJM2383** is a low voltage operation DC/DC converter control IC featuring high side current protection, soft start and standby functions.

It is suitable for power module application and on-board regulators.

■PACKAGE OUTLINE

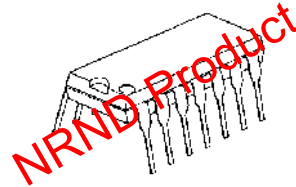

NJM2383D

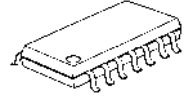

NJM2383M

■FEATURES

- PWM switching control
- Operating Voltage (3.6V to 32V)
- Wide Oscillator Range (5kHz to 350kHz)
- ON/OFF Circuit (High Active)
- Current Sensing Amplifier
- Soft-Start Function
- UVLO(Under Voltage Lockouts)
- Bipolar Technology
- Package Outline DIP14, DMP14

■PIN CONFIGURATION

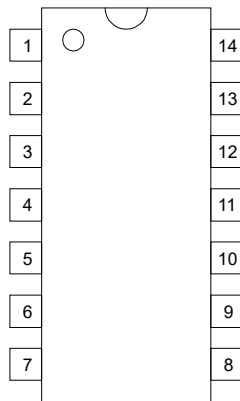

NJM2383D

NJM2383M

PIN FUNCTION

1.NC	14.NC
2.IN-1	13.ON/OFF
3.IN-2	12.REF
4.F.B	11.CT
5.GND	10.CS
6.OUT	9.V ⁺
7.NC	8.NC

■BLOCK DIAGRAM

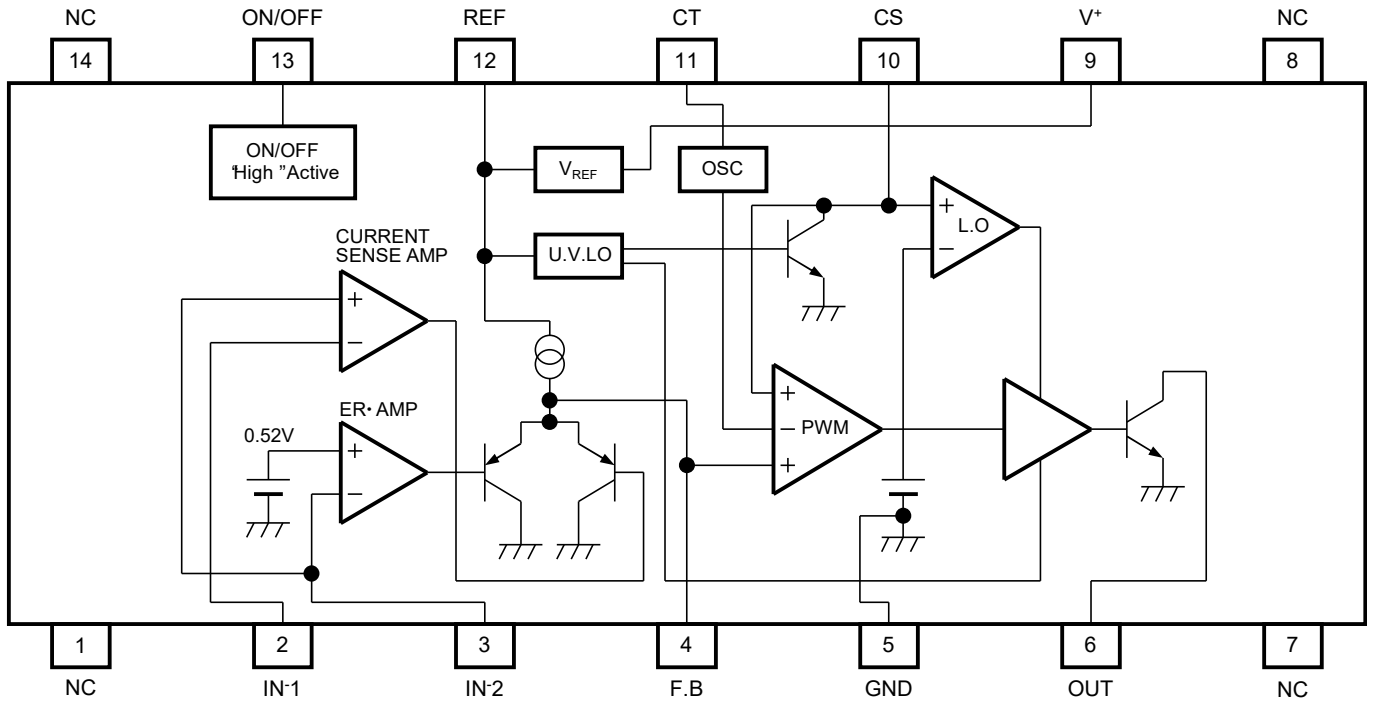

■ABSOLUTE MAXIMUM RATINGS (Ta=25°C)

PARAMETER	SYMBOL	MAXIMUM RATINGS	UNIT
Input Voltage	V ⁺	36	V
Reference Output Current	I _{OR}	10	mA
Output Sink Current	I _{SINK}	200	mA
Differential Input Voltage	V _{ID}	2.5	V
Common Mode Input Voltage	V _{IC}	-0.3 to 2.5	V
ON/OFF Control Voltage	V _{ON/OFF}	-0.3 to 36 (note)	V
Power Dissipation	P _D	(DIP 14) 700 (DMP 14) 300	mW
Operating Temperature Range	T _{OPR}	-40 to 85	°C
Storage Temperature Range	T _{STG}	-50 to 150	°C

(note) When the supply voltage is less than 36V, the absolute maximum input voltage is equal to the supply voltage.

■ELECTRICAL CHARACTERISTICS (V⁺=6V, R_T=33kΩ, C_T=1000pF, V_{ON/OFF}=3V, Ta=25°C)
REFERENCE VOLTAGE BLOCK

PARAMETER	SYMBOL	TEST CONDITION	MIN.	TYP.	MAX.	UNIT
Output Voltage	V _{REF}	I _{OR} =1mA	2.45	2.50	2.55	V
Line Regulation	L _{INE}	V ⁺ =3.6V to 32V, I _{OR} =1mA	-	6.8	20.7	mV
Load Regulation	L _{OAD}	I _{OR} =0.1mA to 5.0mA	-	5	30	mV

OSCILLATOR BLOCK

PARAMETER	SYMBOL	TEST CONDITION	MIN.	TYP.	MAX.	UNIT
Oscillation Frequency	f _{OSC}	R _T =33kΩ, C _T =1000pF	85	105	125	kHz
Oscillate Fluctuations1 (Line Fluctuations)	f _{dV}	V ⁺ =3.6V to 32V	-	1	-	%
Oscillate Fluctuations2 (Temp Fluctuations)	f _{dT}	Ta=-40°C to 85°C	-	5	-	%

CURRENT SENSE AMPLIFIER BLOCK

PARAMETER	SYMBOL	TEST CONDITION	MIN.	TYP.	MAX.	UNIT
Input Offset Voltage1	V _{IO1}		-	2	7	mV
Input Offset Current1	I _{IO1}		-	5	-	nA
Input Bias Current1	I _{B1}		-	20	100	nA
Open Loop Gain1	A _{V1}		-	90	-	dB
Gain Bandwidth Product1	G _{B1}		-	0.6	-	MHz
Input Common Mode Voltage Ratio1	V _{ICM1}		-	0 to V _{REF} -0.8	-	V
Maximum Output Voltage1 (F.B Pin)	V _{OM-1}	R _{NF} =100kΩ	-	-	1	V
Maximum Source Current1 (F.B Pin)	I _{OM+1}	V _{OM} =0.5V	40	85	200	μA

■ELECTRICAL CHARACTERISTICS (V⁺=6V, R_T=33kΩ, C_T=1000pF, V_{ON/OFF}=3V, Ta=25°C)

ERROR AMPLIFIER BLOCK

PARAMETER	SYMBOL	TEST CONDITION	MIN.	TYP.	MAX.	UNIT
Reference Voltage ₂	V _{B2}		0.51	0.52	0.53	V
Input Bias Current ₂	I _{B2}		-	5	100	nA
Open Loop Gain ₂	A _{v2}		-	90	-	dB
Gain Bandwidth Product ₂	G _{B2}		-	0.6	-	MHz
Maximum Output Voltage ₂ (F.B Pin)	V _{OM-2}	R _{NF} =100kΩ	-	-	1	V
Maximum Source Current ₂ (F.B Pin)	I _{OM+2}	V _{OM} =0.5V	40	85	200	μA

PWM COMPARATE BLOCK

PARAMETER	SYMBOL	TEST CONDITION	MIN.	TYP.	MAX.	UNIT
Input Threshold Voltage (F.B Pin)	V _{TH0}	duty·cycle=0% (note)	-	1.65	1.75	V
Input Threshold Voltage (F.B Pin)	V _{TH100}	duty·cycle=100% (note)	-	2.10	-	V

SOFT START CIRCUIT BLOCK

PARAMETER	SYMBOL	TEST CONDITION	MIN.	TYP.	MAX.	UNIT
Input Bias Current (CS Pin)	I _{BCS}	CS Pin=1.8V	-	250	650	nA
Input Threshold Voltage (CS Pin)	V _{THCS0}	duty·cycle=0% (note)	-	0.25	0.35	V
Input Threshold Voltage (CS Pin)	V _{THCS50}	duty·cycle=100% (note)	-	0.7	-	V

UNDER VOLTAGE LOCKOUT BLOCK

PARAMETER	SYMBOL	TEST CONDITION	MIN.	TYP.	MAX.	UNIT
ON Threshold Voltage	V _{THON}		-	2.70	-	V
OFF Threshold Voltage	V _{THOFF}		-	2.52	-	V
Hysteresis Voltage	V _{HYS}		60	180	-	mV

OUTPUT BLOCK

PARAMETER	SYMBOL	TEST CONDITION	MIN.	TYP.	MAX.	UNIT
L-Output Voltage (OUT Pin)	V _{OL}	Output Sink Current=100mA	-	0.25	0.65	V

■ELECTRICAL CHARACTERISTICS (V⁺=6V, R_T=33kΩ, C_T=1000pF, V_{ON/OFF}=3V, Ta=25°C)

ON/OFF BLOCK

PARAMETER	SYMBOL	TEST CONDITION	MIN.	TYP.	MAX.	UNIT
OFF Threshold Voltage (ON/OFF Pin)	V _{OFF}		-	-	0.3	V
ON Threshold Voltage (ON/OFF Pin)	V _{ON}		1.1	-	-	V
Input Bias Current (ON/OFF Pin)	I _{ON/OFF}	V _{ON/OFF} =3V	-	100	120	μA

GENERAL CHARACTERISTICS

PARAMETER	SYMBOL	TEST CONDITION	MIN.	TYP.	MAX.	UNIT
Stand-by Current	I _{CCSTBY}	Stand-by Mode, V _{ON/OFF} =0V	-	12	20	μA
Latch Mode Threshold Voltage (CS Pin)	V _{THLA}		1.2	1.5	1.8	V
Quiescent Current	I _{CCLA}	Latch Mode	-	1.6	2.2	mA
Average Quiescent Current	I _{CCAV}	RL = ∞, duty cycle=50%	-	5.5	10	mA

(note) Duty Cycle is defined as follows:

Duty Cycle=0%: IC output transistor is OFF.

Duty Cycle=100%: IC output transistor is ON.

■TYPICAL APPLICATIONS

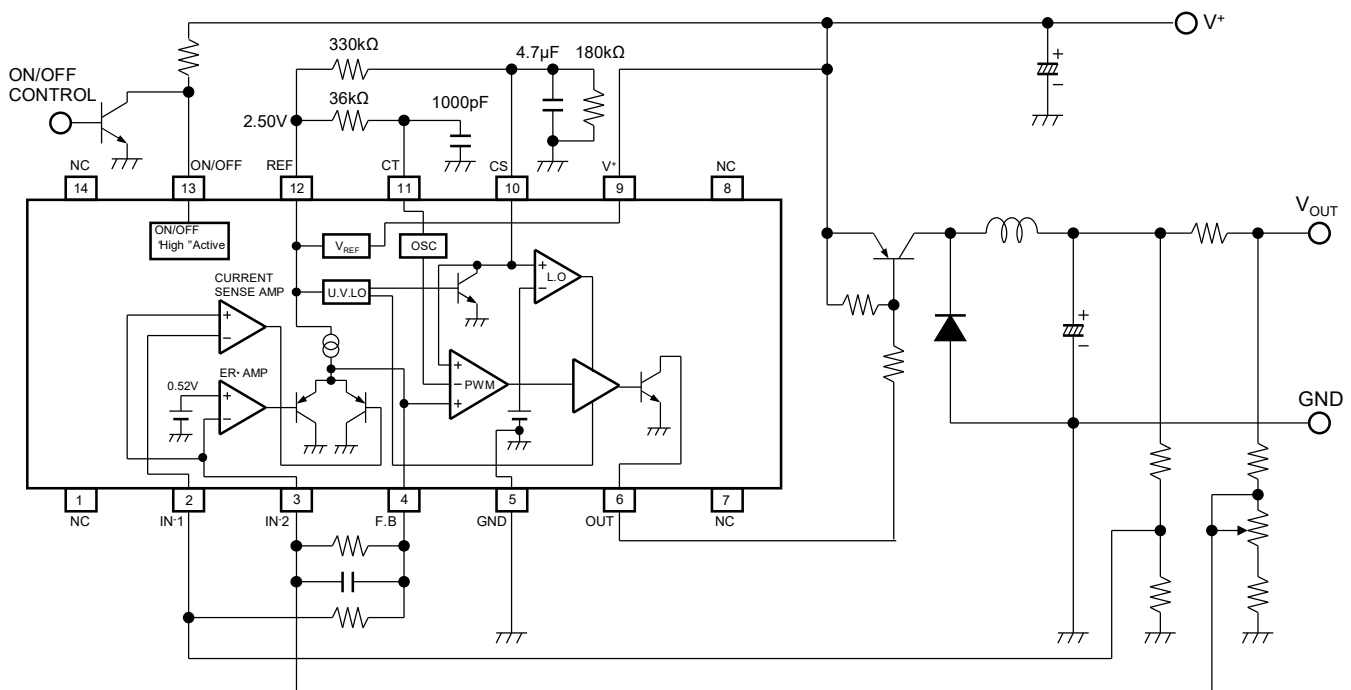

■ TYPICAL CHARACTERISTICS

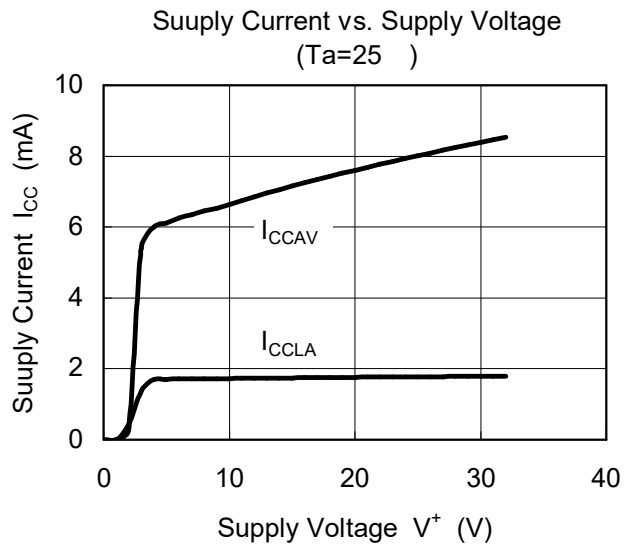
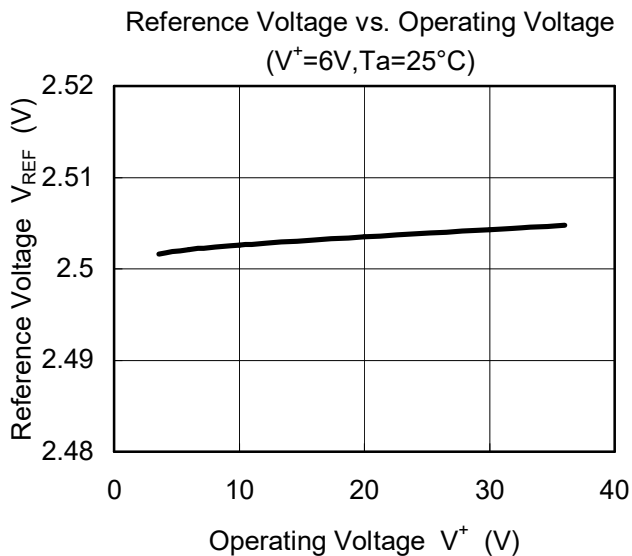
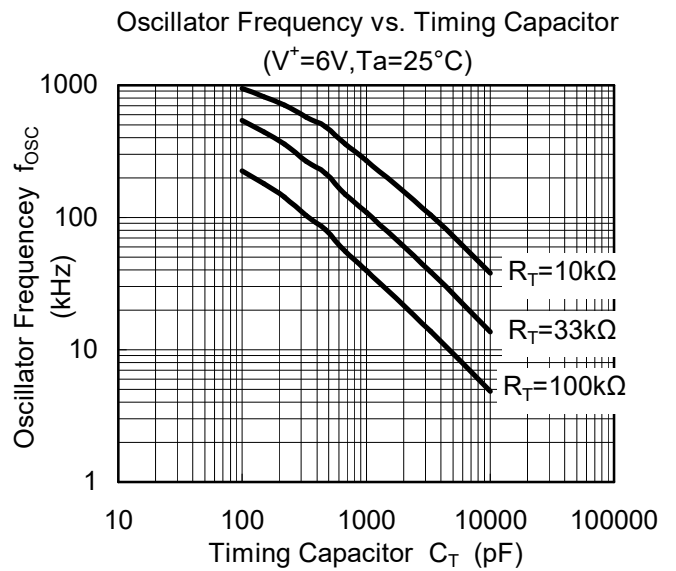
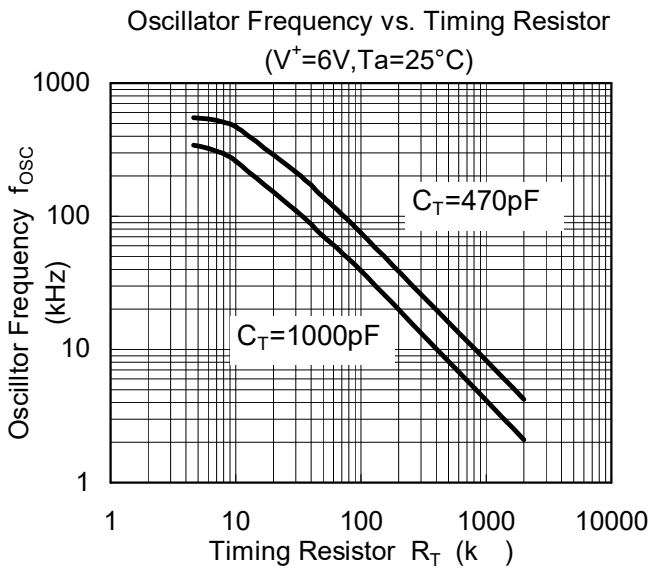
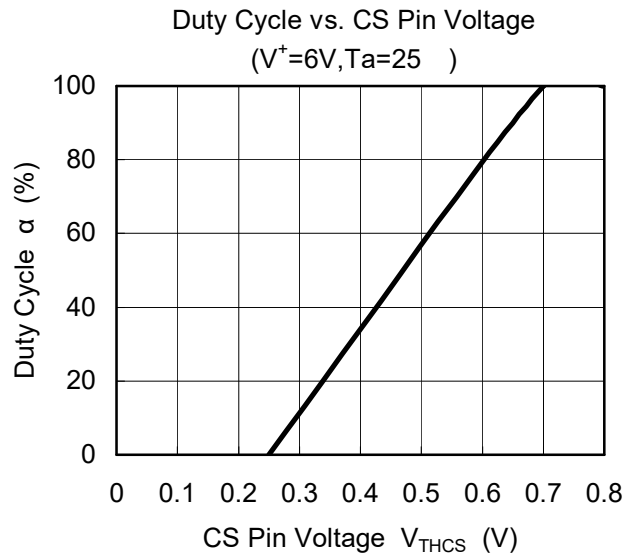
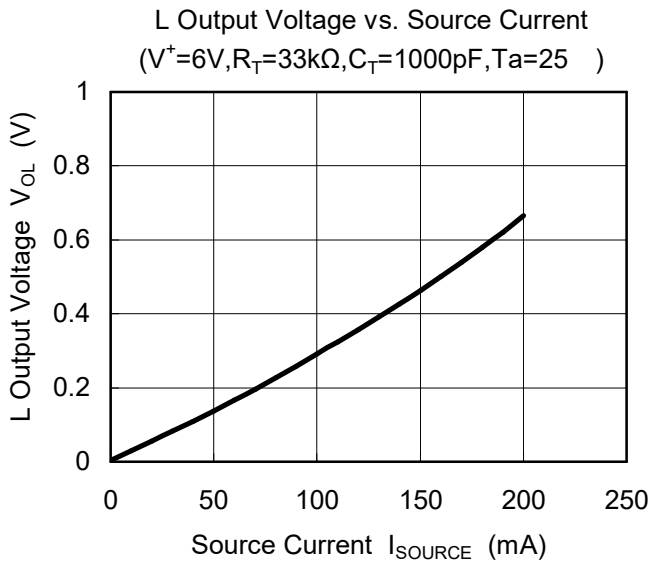

■ TYPICAL CHARACTERISTICS

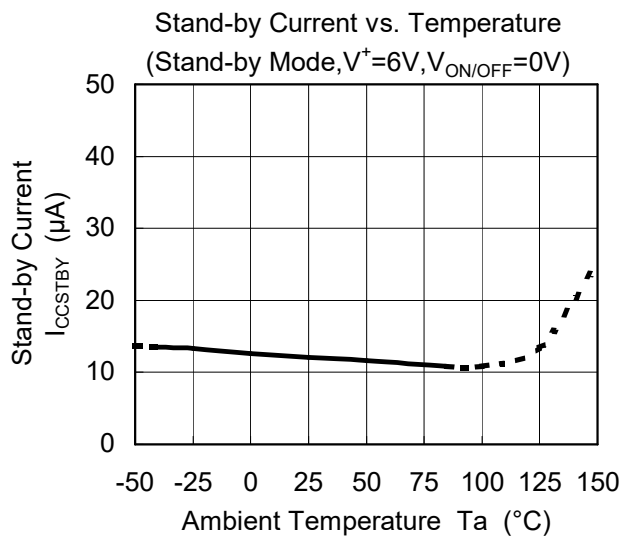
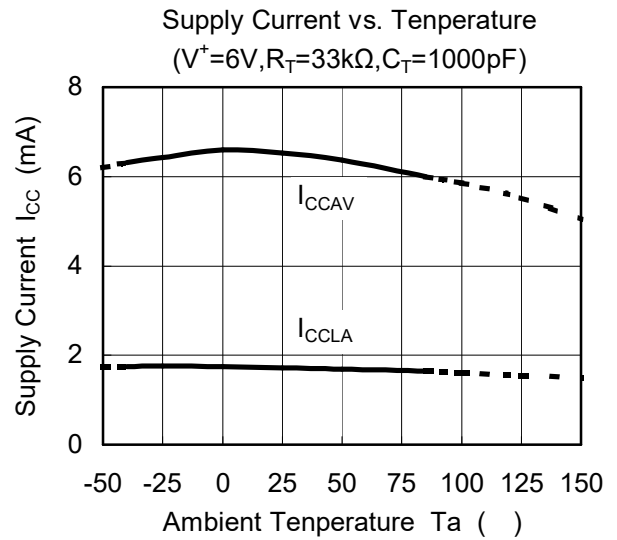
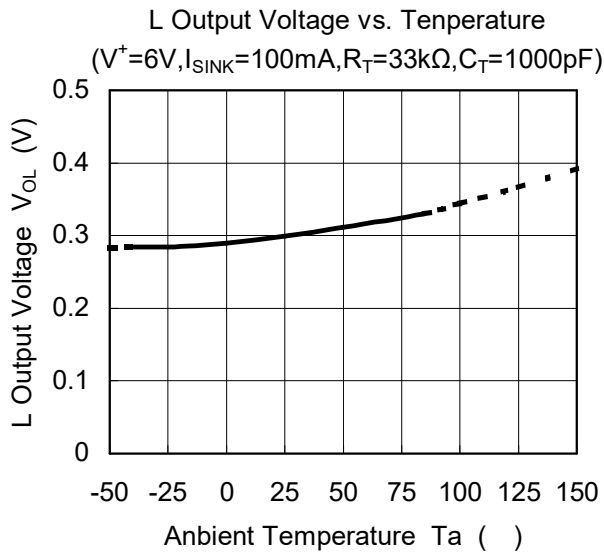
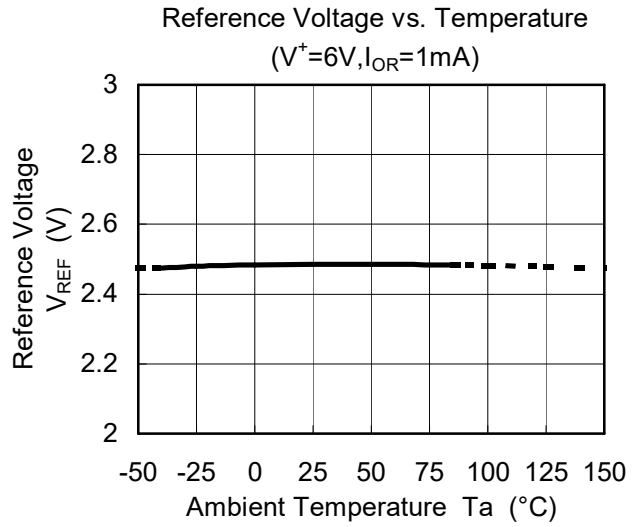
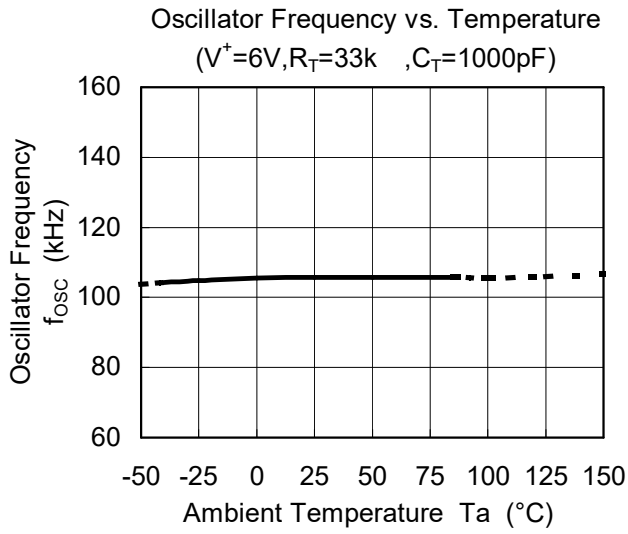

[CAUTION]

1. NJR strives to produce reliable and high quality semiconductors. NJR's semiconductors are intended for specific applications and require proper maintenance and handling. To enhance the performance and service of NJR's semiconductors, the devices, machinery or equipment into which they are integrated should undergo preventative maintenance and inspection at regularly scheduled intervals. Failure to properly maintain equipment and machinery incorporating these products can result in catastrophic system failures
2. The specifications on this datasheet are only given for information without any guarantee as regards either mistakes or omissions. The application circuits in this datasheet are described only to show representative usages of the product and not intended for the guarantee or permission of any right including the industrial property rights.
All other trademarks mentioned herein are the property of their respective companies.
3. To ensure the highest levels of reliability, NJR products must always be properly handled.
The introduction of external contaminants (e.g. dust, oil or cosmetics) can result in failures of semiconductor products.
4. NJR offers a variety of semiconductor products intended for particular applications. It is important that you select the proper component for your intended application. You may contact NJR's Sale's Office if you are uncertain about the products listed in this datasheet.
5. Special care is required in designing devices, machinery or equipment which demand high levels of reliability. This is particularly important when designing critical components or systems whose failure can foreseeably result in situations that could adversely affect health or safety. In designing such critical devices, equipment or machinery, careful consideration should be given to amongst other things, their safety design, fail-safe design, back-up and redundancy systems, and diffusion design.
6. The products listed in this datasheet may not be appropriate for use in certain equipment where reliability is critical or where the products may be subjected to extreme conditions. You should consult our sales office before using the products in any of the following types of equipment.
 - Aerospace Equipment
 - Equipment Used in the Deep Sea
 - Power Generator Control Equipment (Nuclear, steam, hydraulic, etc.)
 - Life Maintenance Medical Equipment
 - Fire Alarms / Intruder Detectors
 - Vehicle Control Equipment (Automobile, airplane, railroad, ship, etc.)
 - Various Safety Devices
7. NJR's products have been designed and tested to function within controlled environmental conditions. Do not use products under conditions that deviate from methods or applications specified in this datasheet. Failure to employ the products in the proper applications can lead to deterioration, destruction or failure of the products. NJR shall not be responsible for any bodily injury, fires or accident, property damage or any consequential damages resulting from misuse or misapplication of the products. The products are sold without warranty of any kind, either express or implied, including but not limited to any implied warranty of merchantability or fitness for a particular purpose.
8. Warning for handling Gallium and Arsenic (GaAs) Products (Applying to GaAs MMIC, Photo Reflector). These products use Gallium (Ga) and Arsenic (As) which are specified as poisonous chemicals by law. For the prevention of a hazard, do not burn, destroy, or process chemically to make them as gas or power. When the product is disposed of, please follow the related regulation and do not mix this with general industrial waste or household waste.
9. The product specifications and descriptions listed in this datasheet are subject to change at any time, without notice.

