

SINGLE SUPPLY DUAL AMPLIFIER

■ GENERAL DESCRIPTION

The NJM12904 is a single-supply dual operational amplifier, which can operate from 2V supply. The features are low offset voltage, low bias current.

The package lineup is DIP, SIP, DMP and others compact so that the NJM12904 is suitable for audio for low voltage operation and any other kind of signal amplifier.

■ FEATURES

- Operating Voltage +2V to +14V
- Input Offset Voltage 5mV max.
- Slew Rate 0.7V/μs typ.
- Operating Current 0.7mA typ.
- Bipolar Technology
- Package Outline DIP8, SIP8, DMP8,
SOP8 JEDEC 150mil, SSOP8
MSOP8 (VSP8)MEET JEDEC MO-187-DA
MSOP8 (TVSP8)MEET JEDEC MO-187-DA/THIN TYPE

■ PACKAGE OUTLINE



NJM12904D
(DIP8)



NJM12904L
(SIP8)

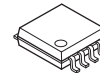

NJM12904M
(DMP8)



NJM12904E
(SOP8)



NJM12904V
(SSOP8)



NJM12904R/RB1
(MSOP8(VSP8))
(MSOP8(TVSP8))

NRND Product

■ PIN CONFIGURATION

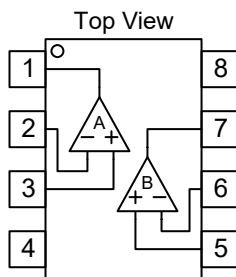

NJM12904D/12904M/12904E
NJM12904V/12904R/12904RB1

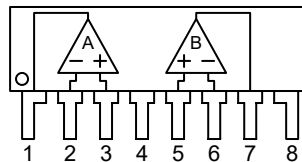

NJM12904L

PIN FUNCTION

1. A OUTPUT
2. A -INPUT
3. A +INPUT
4. GND(V⁻)
5. B +INPUT
6. B -INPUT
7. B OUTPUT
8. V⁺

■ EQUIVALENT CIRCUIT (1/2Shown)

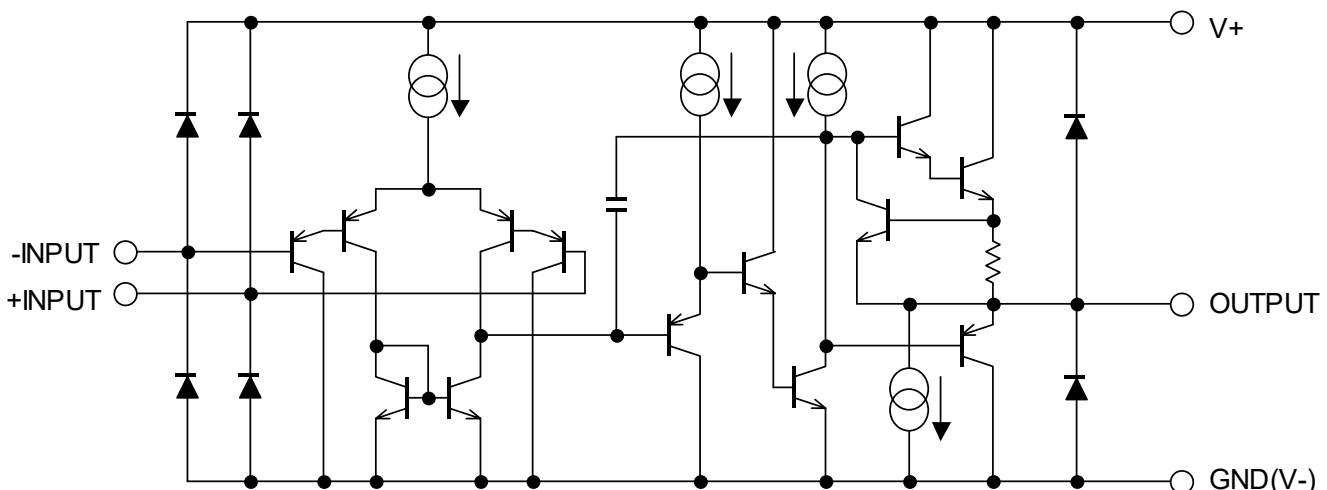

■ **ABSOLUTE MAXIMUM RATING** (Ta=25°C)

PARAMETER	SYMBOL	RATING	UNIT
Supply Voltage	V ⁺	15	V
Differential Input Voltage	V _{ID}	14 (Note1)	V
Input Voltage	V _{IC}	-0.3~+14 (Note1)	V
Power Dissipation (stand alone)	P _D	DIP8: 500 DMP8: 300 SOP8: 300 SSOP8: 250 MSOP8(VSP8/TVSP8): 320 SIP8: 800	mW
Operating Temperature Range	T _{opr}	-40~+85	°C
Storage Temperature Range	T _{stg}	-50~+125	°C

(Note1) For supply voltage less than 14V, the absolute maximum rating is equal to the supply voltage.

■ **ELECTRICAL CHARACTERISTICS** (V⁺=5V, Ta=25°C)

PARAMETER	SYMBOL	TEST CONDITION	MIN.	TYP.	MAX.	UNIT
Operating Voltage	V _{opr}		2	-	14	V
Input Offset Voltage	V _{IO}	R _S =0Ω	-	1	5	mV
Input Offset Current	I _{IO}		-	5	50	nA
Input Bias Current	I _B		-	20	150	nA
Large Signal Voltage Gain	A _V	R _L ≥2kΩ	-	100	-	dB
Maximum Output Voltage Swing	V _{OPP}	R _L =2kΩ	3.5	-	-	V
Common Mode Input Voltage Range	V _{ICM}		0~3.5	-	-	V
Common Mode Rejection Ratio	CMR		-	85	-	dB
Supply Voltage Rejection Ratio	SVR		-	100	-	dB
Output Source Current	I _{SOURCE}	V _{IN+} =1V, V _{IN-} =0V	20	40	-	mA
Output Sink Current	I _{SINK}	V _{IN+} =0V, V _{IN-} =1V	8	30	-	mA
Channel Separation	CS	f=1k~20kHz	-	120	-	dB
Operating Current	I _{CC}	R _L =∞	-	0.7	1.2	mA
Slew Rate	SR	R _L =2kΩ, A _V =0dB, f=1kHz	-	0.7	-	V/μs
Gain Bandwidth Product	GB		-	1.5	-	MHz

■ TYPICAL CHARACTERISTICS

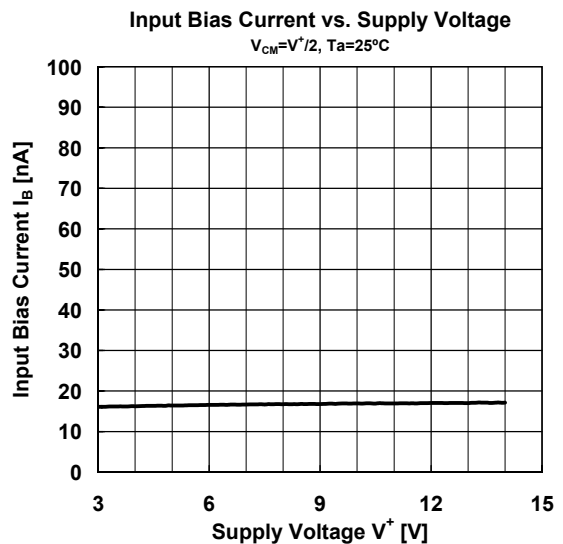
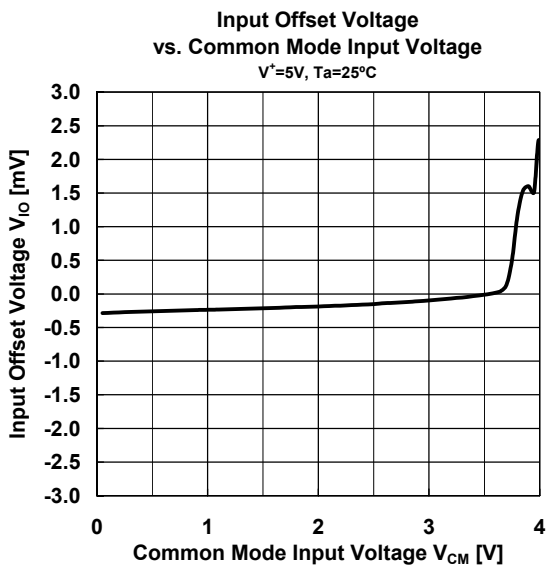
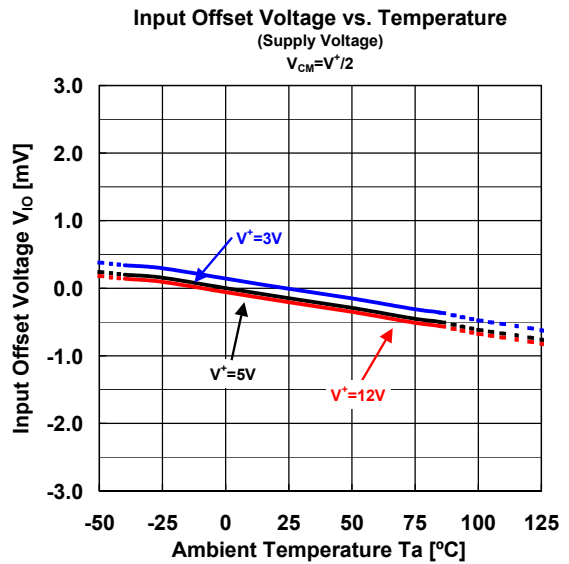
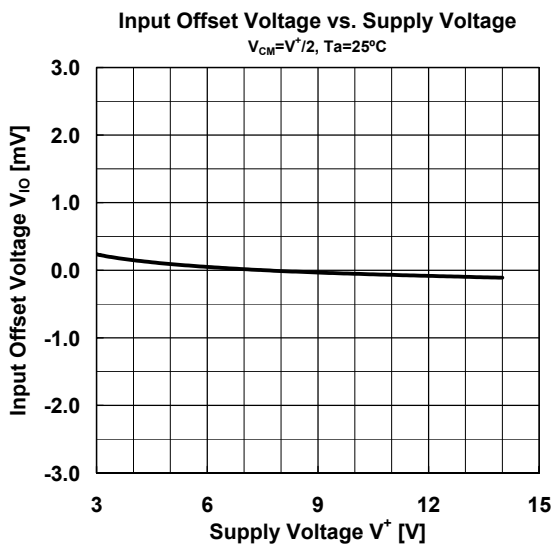
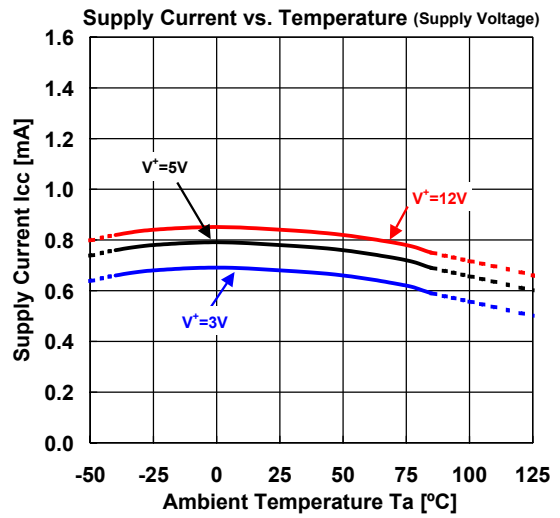
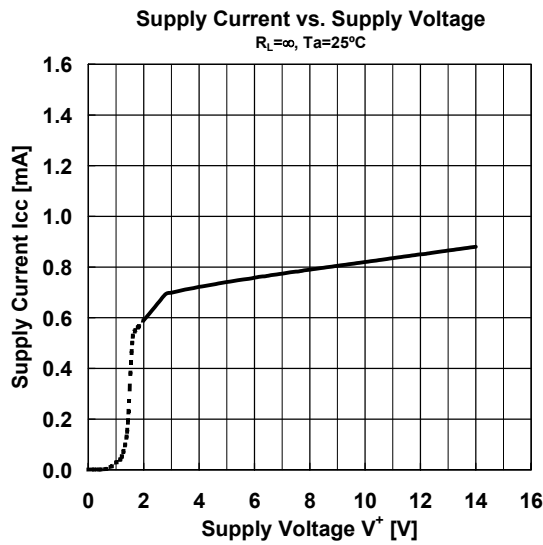

■ TYPICAL CHARACTERISTICS

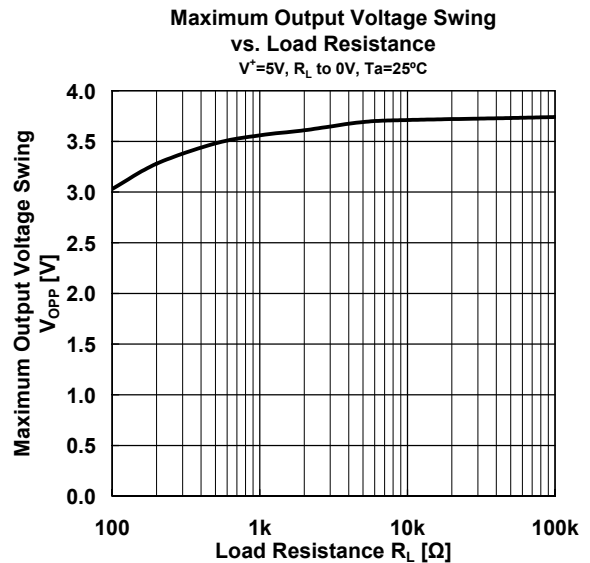
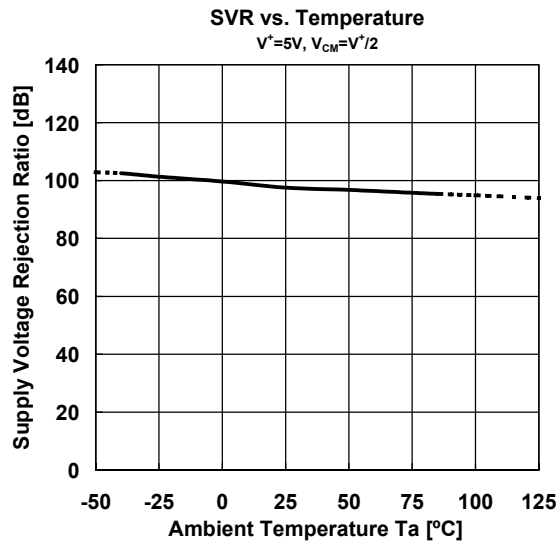
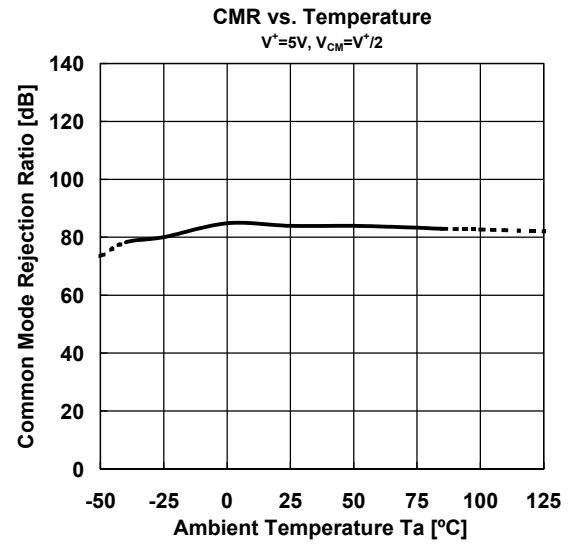
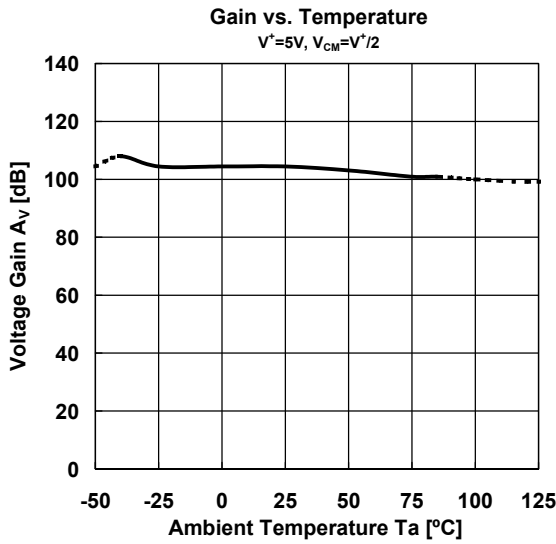
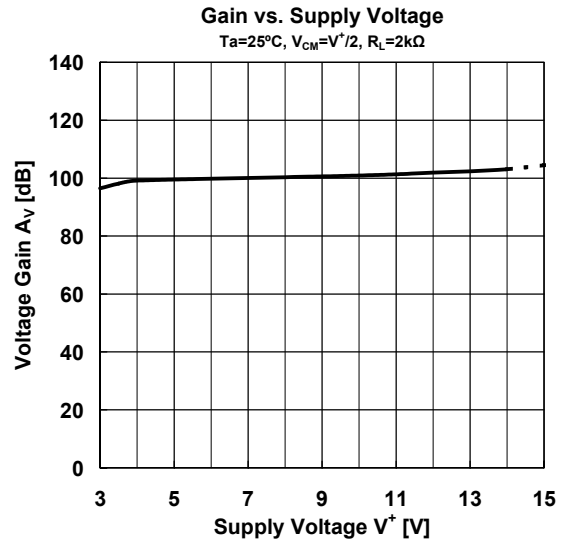
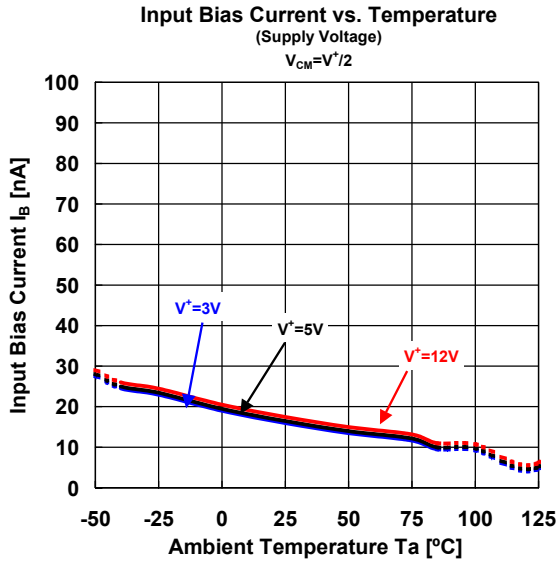

■ TYPICAL CHARACTERISTICS

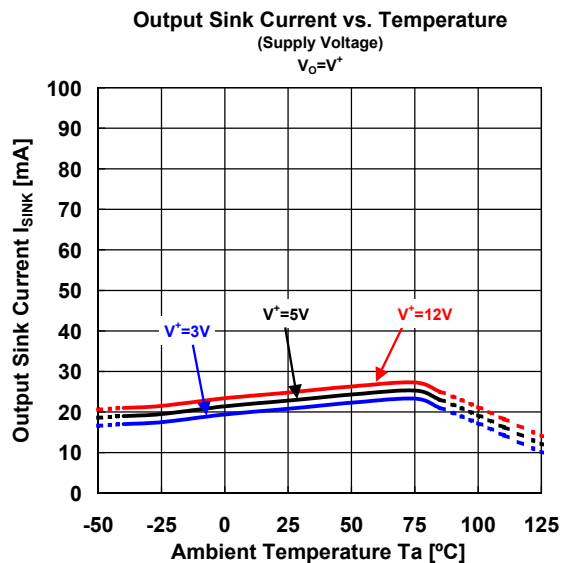
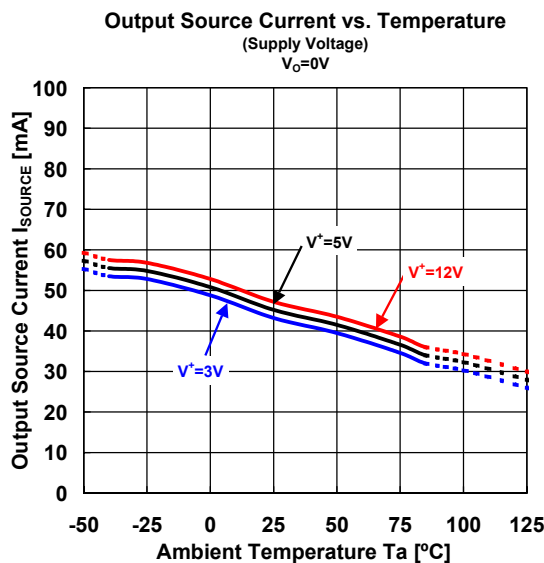
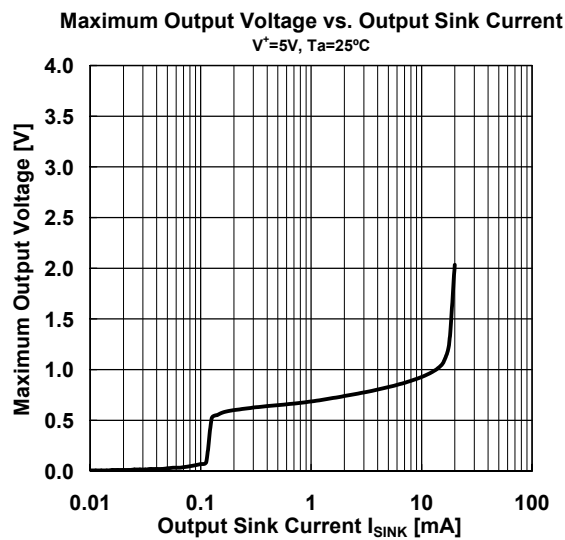
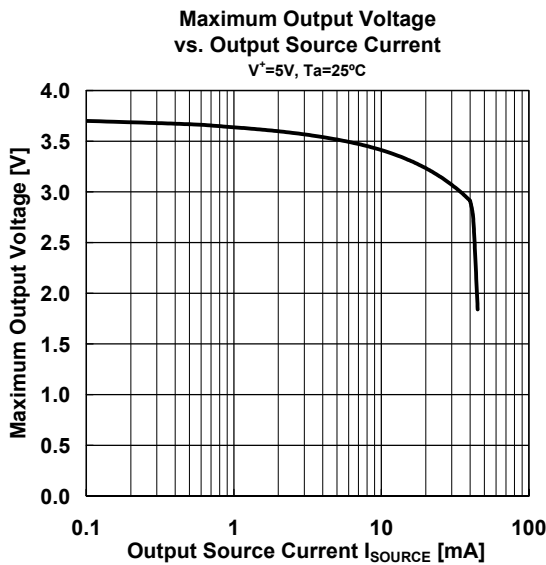
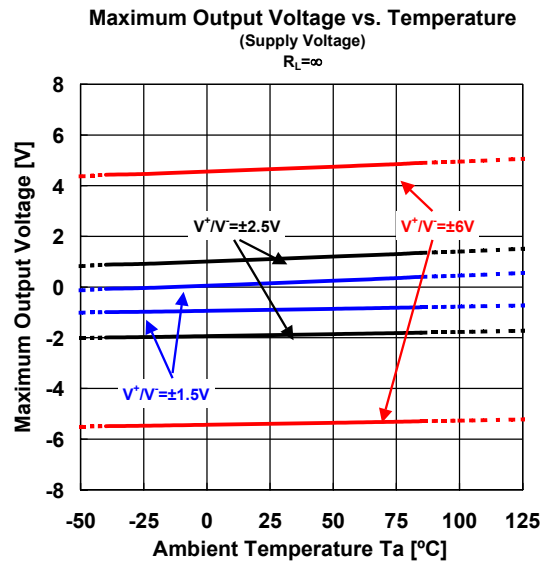
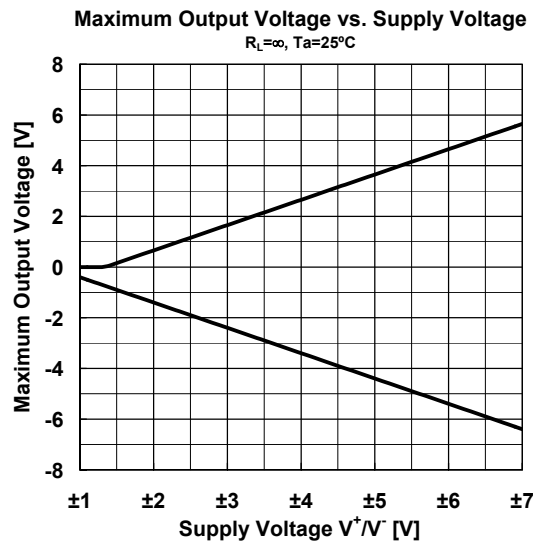

■ TYPICAL CHARACTERISTICS

Maximum Output Voltage Swing vs. Frequency
 $V^+=5V, V_{CM}=2.5V, R_L$ to 2.5V, $T_a=25^\circ C$

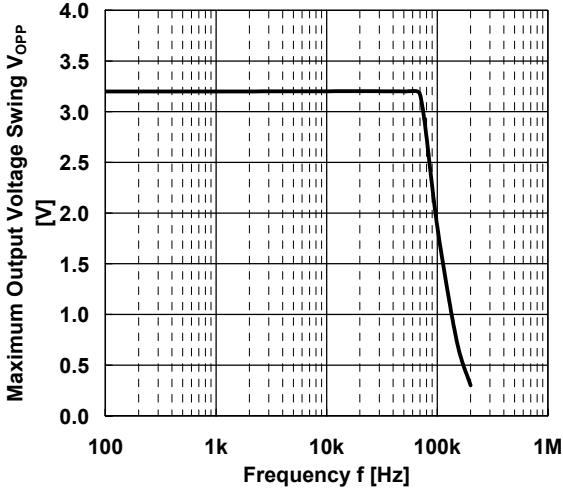

40dB Gain/Phase vs. Frequency
 $V^+=5V, R_L=\infty, T_a=25^\circ C$

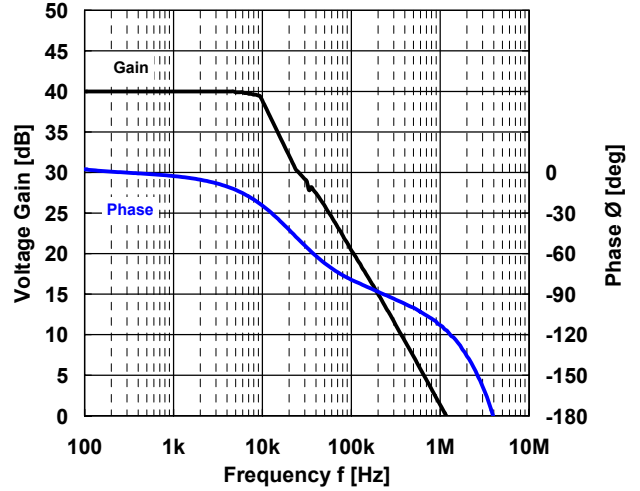

Pulse Response (Rise)
 $V^+=5V, T_a=25^\circ C$

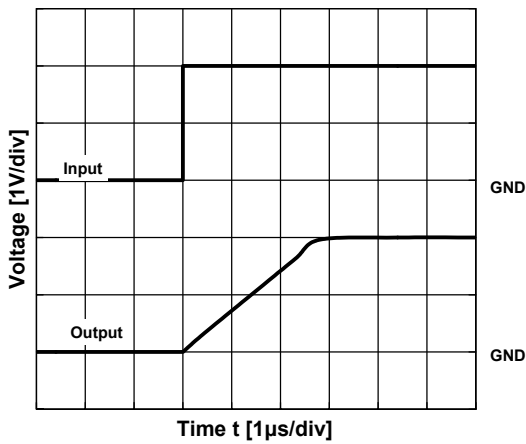

Pulse Response (Fall)
 $V^+=5V, T_a=25^\circ C$

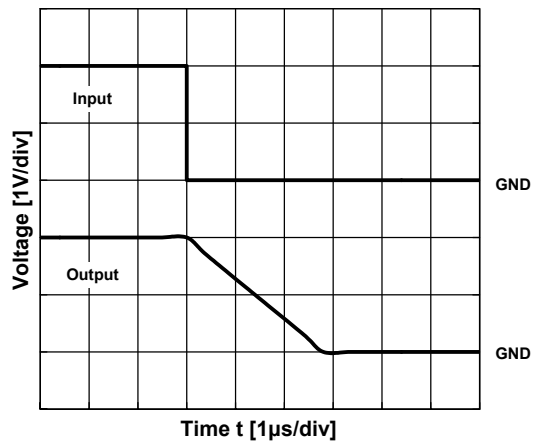

[CAUTION]
 The specifications on this data book are only given for information, without any guarantee as regards either mistakes or omissions. The application circuits in this data book are described only to show representative usages of the product and not intended for the guarantee or permission of any right including the industrial rights.