

SPDT SWITCH GaAs MMIC

■ FEATURES

- AEC-Q100 grade 2 qualified
- Control voltage $V_{CTL(H)} = 3.0$ V typ.
- Low insertion loss
 - 0.35 dB typ. @ $f = 0.3$ to 2.5 GHz
 - 0.45 dB typ. @ $f = 4.9$ to 5.9 GHz
 - 0.60 dB typ. @ $f = 8.5$ GHz
- High isolation
 - 28 dB typ. @ $f = 0.3$ to 2.5 GHz
 - 27 dB typ. @ $f = 4.9$ to 5.9 GHz
 - 18 dB typ. @ $f = 8.5$ GHz
- $P_{-1dB} = +31$ dBm typ. @ $f = 0.3$ GHz, 2.5 GHz, 5.9 GHz
- Package with wettable flank ESON6-GC (1.6 x 1.6 x 0.78 mm typ., pin pitch 0.5 mm)
- RoHS compliant and Halogen Free, MSL1

■ APPLICATION

- 802.11 a/b/g/n/ac/ax and BT networks applications
- UWB (ultra-wide band) applications
- RKE applications
- General purpose switching applications

■ BLOCK DIAGRAM (ESON6-GC)

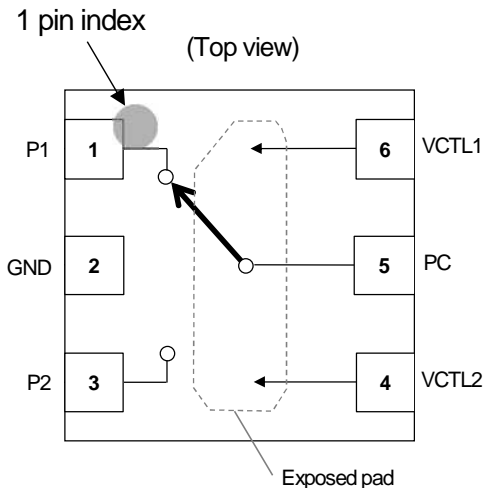

■ GENERAL DESCRIPTION

The NJG1801AKGC-A is a GaAs SPDT switch MMIC suited for switching transmit/receive signals on sub GHz ISM band, Bluetooth, 802.11 a/b/g/n/ac/ax, and UWB applications.

This switch features low insertion loss, high isolation, high handling power, and ultra-wide frequency coverage up to 8.5 GHz.

ESON6-GC package with wettable flank structure corresponds to Automated Optical Inspection (AOI).

■ TRUTH TABLE

“H” = $V_{CTL(H)}$, “L” = $V_{CTL(L)}$

VCTL1	VCTL2	ON Path
L	H	PC-P1
H	L	PC-P2

■ PIN CONFIGURATION

PIN NO.	SYMBOL	DESCRIPTION
1	P1	RF input/output
2	GND	Ground terminal
3	P2	RF input/output
4	VCTL2	Control signal input terminal
5	PC	RF input/output
6	VCTL1	Control signal input terminal
Exposed pad	GND	Ground terminal

Automotive NJG1801AKGC-A

■ PRODUCT NAME INFORMATION

NJG1801A KGC -A (TE3)
 | |
 Part number Package Automotive Taping form

■ ORDERING INFORMATION

PART NUMBER	PACKAGE OUTLINE	RoHS	HALOGEN-FREE	TERMINAL FINISH	MARKING	WEIGHT (mg)	MOQ (pcs.)
NJG1801AKGC-A	ESON6-GC	Yes	Yes	SnBi	1801A A	5.4	3,000

■ ABSOLUTE MAXIMUM RATINGS

(General conditions: $T_a = +25^\circ\text{C}$, $Z_s = Z_l = 50 \Omega$)

PARAMETER	SYMBOL	RATINGS	UNIT
RF Input Power	P_{IN}	+31 ⁽¹⁾	dBm
Control Voltage	V_{CTL}	6.0	V
Power Dissipation ⁽²⁾	P_D	1100	mW
Operating Temperature	T_{opr}	-40 to +105	$^\circ\text{C}$
Storage Temperature	T_{stg}	-55 to +150	$^\circ\text{C}$

(1): $V_{CTL(L)} = 0\text{V}$, $V_{CTL(H)} = 3.0\text{V}$, on state port

(2): 4-layer FR4 PCB with through-hole (101.5 x 114.5 mm), $T_j = 150^\circ\text{C}$

■ POWER DISSIPATION VS.AMBIENT TEMPERATURE

Please, refer to the following Power Dissipation and Ambient Temperature.

(Please note the surface mount package has a small maximum rating of Power Dissipation [P_D], a special attention should be paid in designing of thermal radiation.)

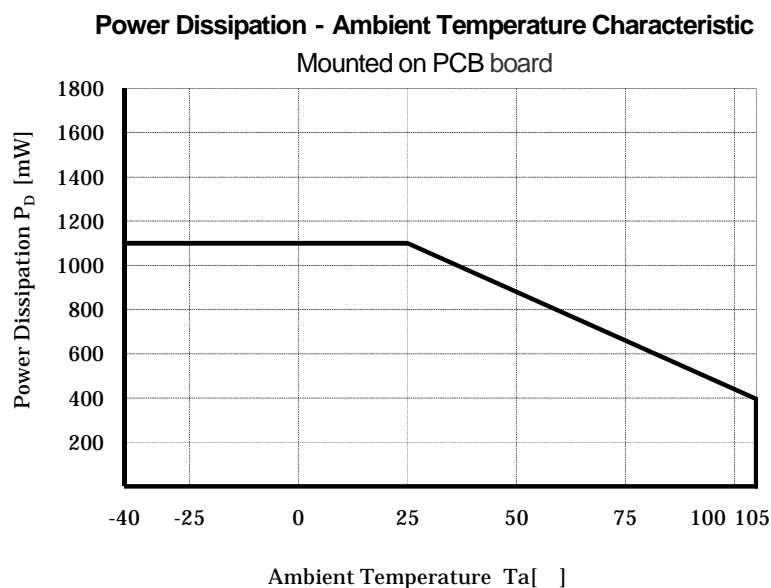

Automotive NJG1801AKGC-A

■ ELECTRICAL CHARACTERISTICS 1 (DC CHARACTERISTICS)

(General conditions: $T_a = +25^\circ\text{C}$, with application circuit)

PARAMETER	SYMBOL	TEST CONDITION	MIN.	TYP.	MAX.	UNIT
Control Voltage (HIGH)	$V_{CTL(H)}$		1.8	3.0	5.0	V
Control Voltage (LOW)	$V_{CTL(L)}$		-0.2	-	0.2	V
Control Current	I_{CTL}		-	5	10	μA

■ ELECTRICAL CHARACTERISTICS 2 (RF CHARACTERISTICS)

(General conditions: $V_{CTL(H)} = 3.0\text{ V}$, $V_{CTL(L)} = 0\text{ V}$, $T_a = +25^\circ\text{C}$, $Z_S = Z_I = 50\ \Omega$, with application circuit)

PARAMETER	SYMBOL	TEST CONDITION	MIN.	TYP.	MAX.	UNIT
Insertion loss1	LOSS1	$f = 0.3\text{ to }2.5\text{ GHz}$	-	0.35	0.55	dB
Insertion loss2	LOSS2	$f = 4.9\text{ to }5.9\text{ GHz}$	-	0.45	0.70	dB
Insertion loss3	LOSS3	$f = 8.5\text{ GHz}$	-	0.60	0.80	dB
Isolation1	ISL1	$f = 0.3\text{ to }2.5\text{ GHz}$	25	28	-	dB
Isolation2	ISL2	$f = 4.9\text{ to }5.9\text{ GHz}$	24	27	-	dB
Isolation3	ISL3	$f = 8.5\text{ GHz}$	16	18	-	dB
Return loss1	RL1	$f = 0.3\text{ to }2.5\text{ GHz}$	18	28	-	dB
Return loss2	RL2	$f = 4.9\text{ to }5.9\text{ GHz}$	10	15	-	dB
Return loss3	RL3	$f = 8.5\text{ GHz}$	10	14	-	dB
Input power at 1dB compression point1	P_{-1dB1}	$f = 0.3\text{ to }2.5\text{ GHz}$	+29	+31	-	dBm
Input power at 1dB compression point2	P_{-1dB2}	$f = 4.9\text{ to }5.9\text{ GHz}$	+28	+31	-	dBm
Input power at 1dB compression point3	P_{-1dB3}	$f = 8.5\text{ GHz}$	+11	-	-	dBm
Switching time	T_{SW}	50% V_{CTL} to 10%/90% RF	-	100	300	ns

Automotive NJG1801AKGC-A

■ ELECTRICAL CHARACTERISTICS (With application circuit, loss of external circuit are excluded.)

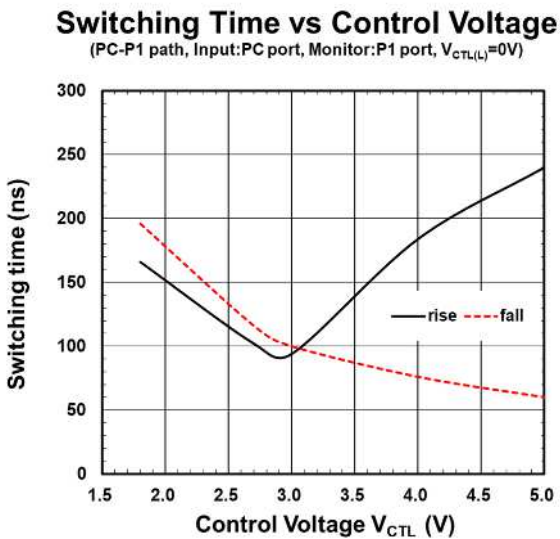
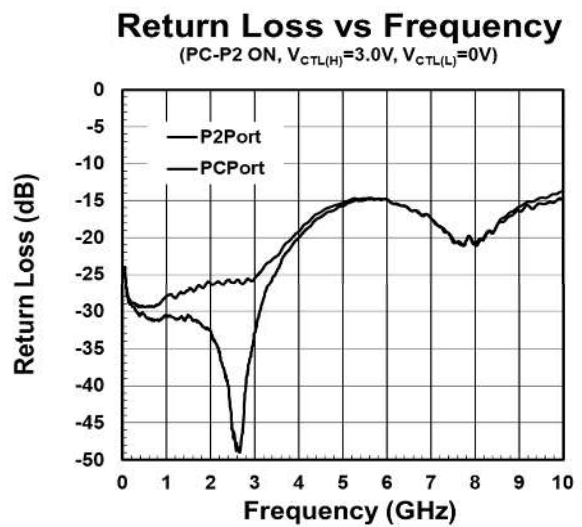
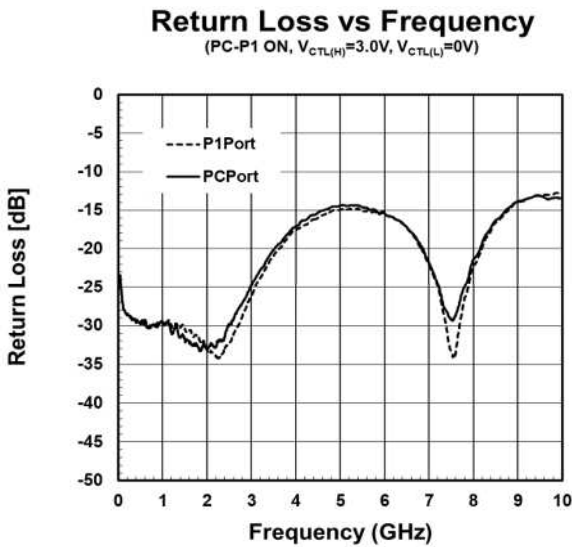
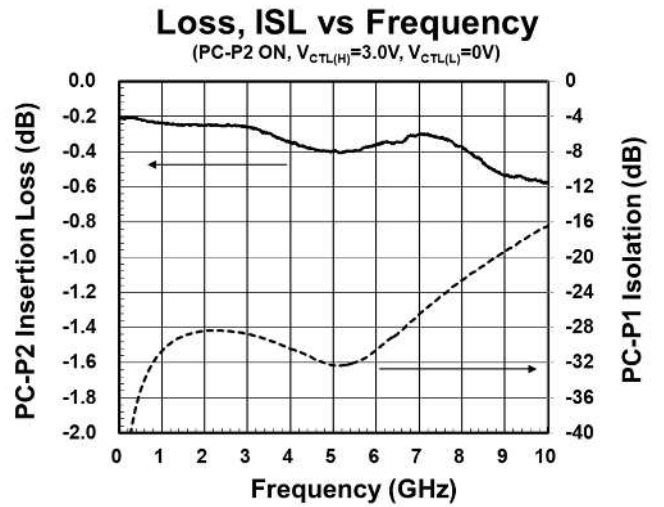
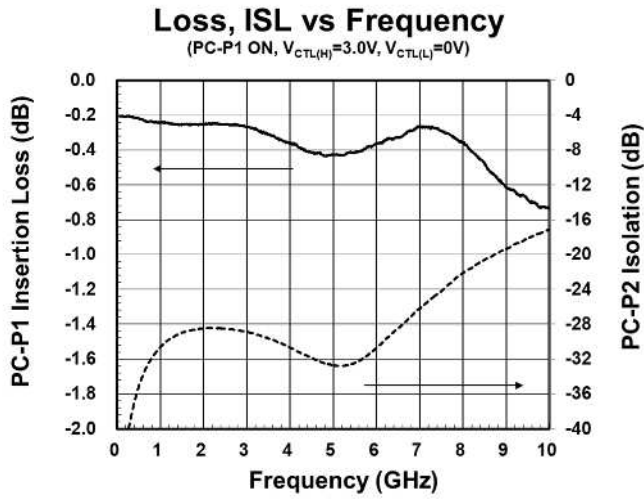

Automotive NJG1801AKGC-A

■ ELECTRICAL CHARACTERISTICS (With application circuit, loss of external circuit are excluded.)

Output Power, I_{CTL} vs Input Power
($f=0.3\text{GHz}$, PC-P1 ON, $V_{CTL(L)}=0\text{V}$)

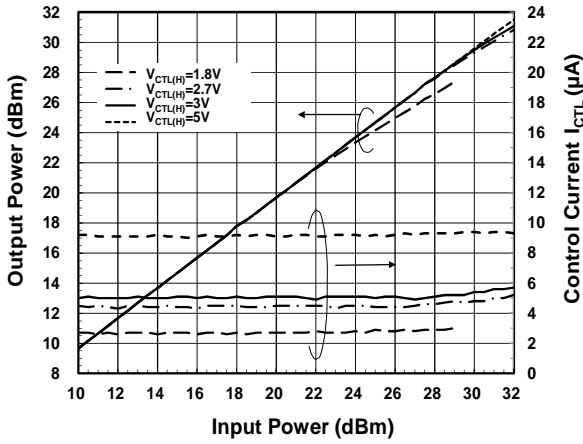

Loss, ISL vs Input Power
($f=0.3\text{GHz}$, PC-P1 ON, $V_{CTL(L)}=0\text{V}$)

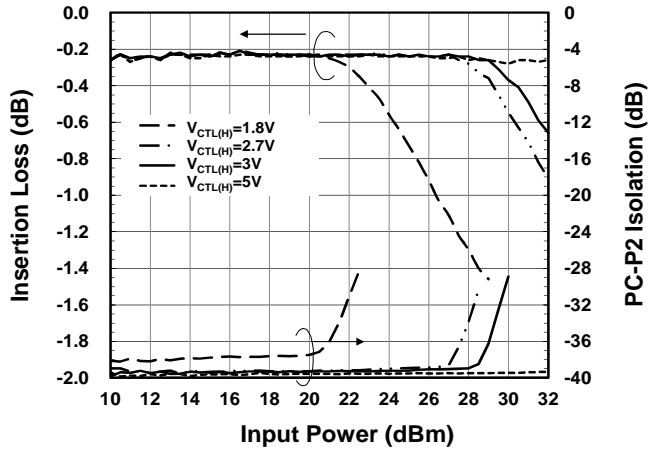

Output Power, I_{CTL} vs Input Power
($f=2.5\text{GHz}$, PC-P1 ON, $V_{CTL(L)}=0\text{V}$)

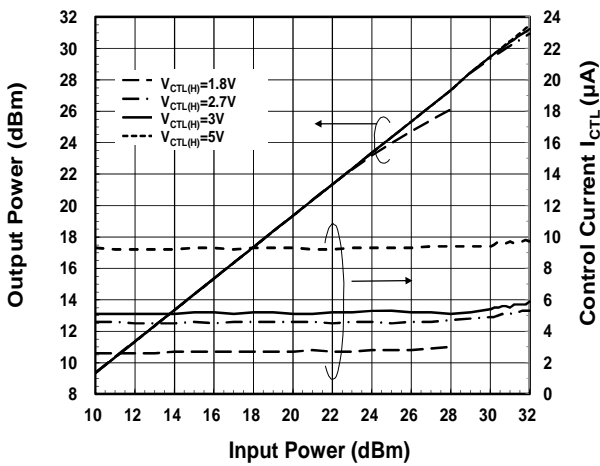

Loss, ISL vs Input Power
($f=2.5\text{GHz}$, PC-P1 ON, $V_{CTL(L)}=0\text{V}$)

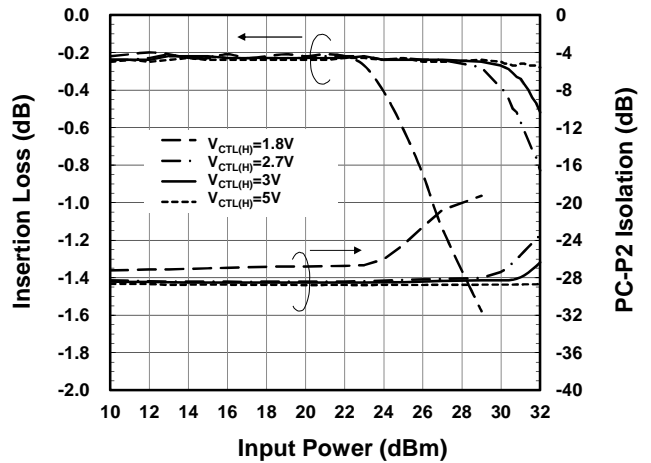

Output Power, I_{CTL} vs Input Power
($f=5.9\text{GHz}$, PC-P1 ON, $V_{CTL(L)}=0\text{V}$)

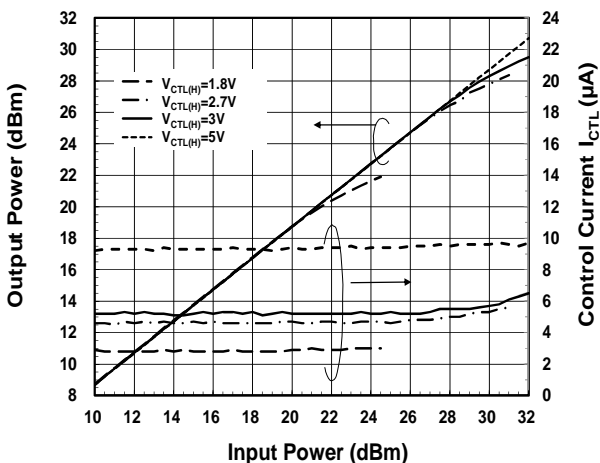

Loss, ISL vs Input Power
($f=5.9\text{GHz}$, PC-P1 ON, $V_{CTL(L)}=0\text{V}$)

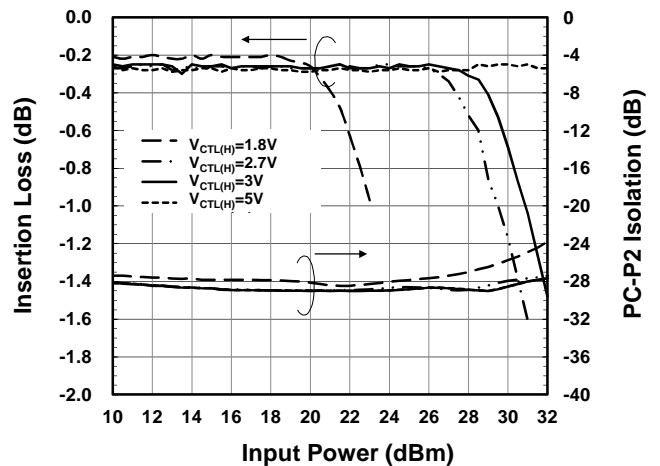

Automotive NJG1801AKGC-A

■ ELECTRICAL CHARACTERISTICS (With application circuit, loss of external circuit are excluded.)

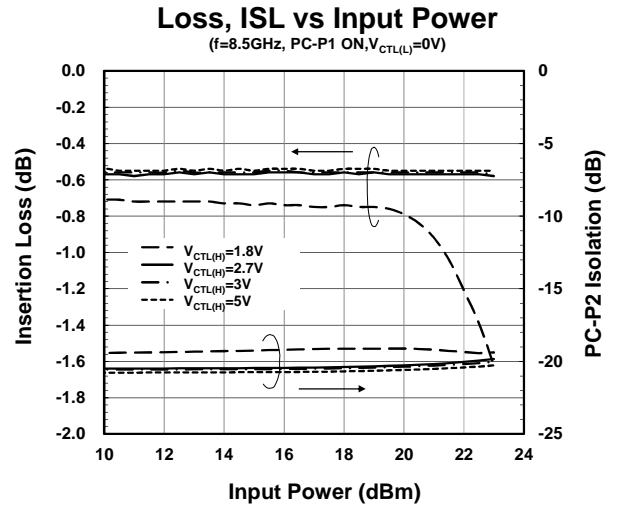
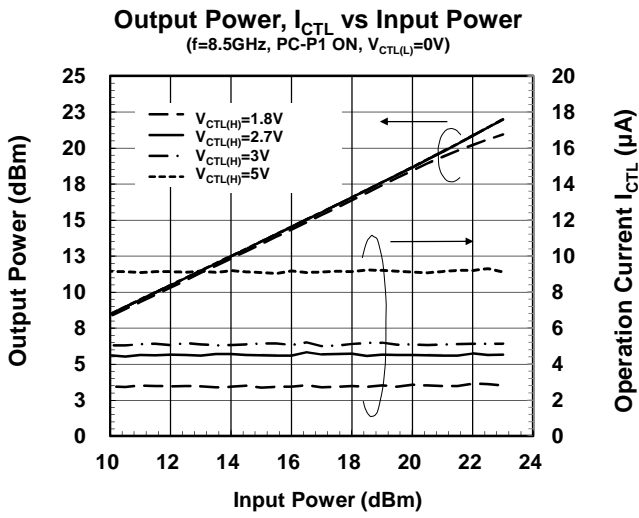

Automotive NJG1801AKGC-A

■ ELECTRICAL CHARACTERISTICS (With application circuit, loss of external circuit are excluded.)

Loss, ISL vs Ambient Temperature

(f=2.5GHz, PC-P1 ON, $V_{CTL(L)}=0$)

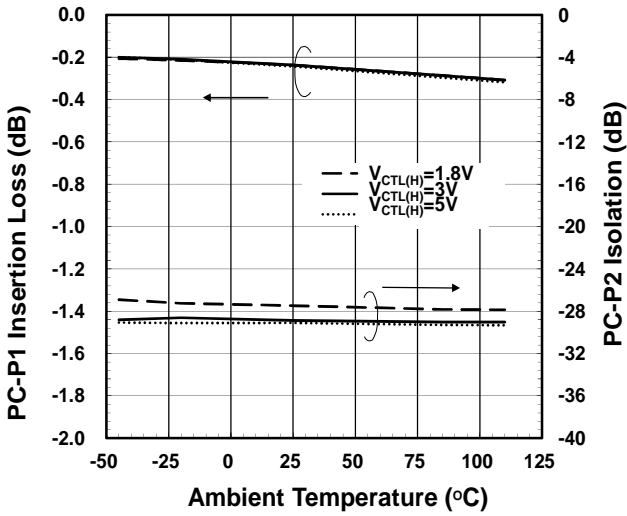

Loss, ISL vs Ambient Temperature

(f=5.9GHz, PC-P1 ON, $V_{CTL(L)}=0$)

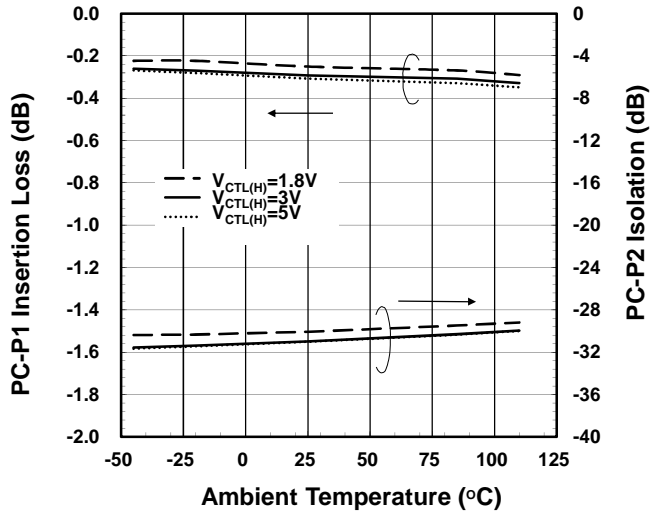

Loss, ISL vs Ambient Temperature

(f=8.5GHz, PC-P1 ON, $V_{CTL(L)}=0$)

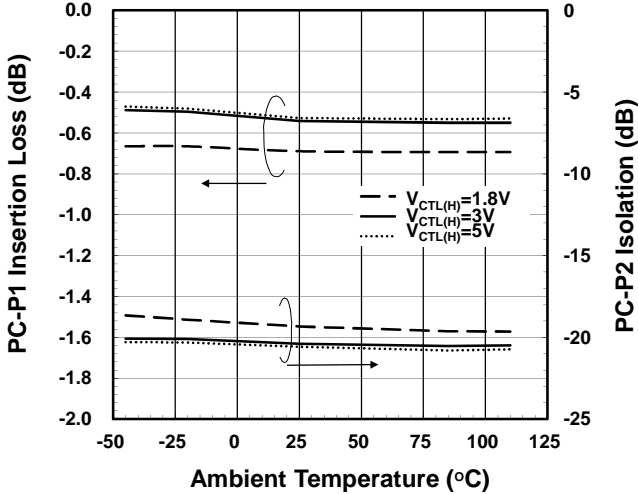

Return Loss vs Ambient Temperature

(f=2.5GHz, PC-P1 ON, $V_{CTL(L)}=0$)

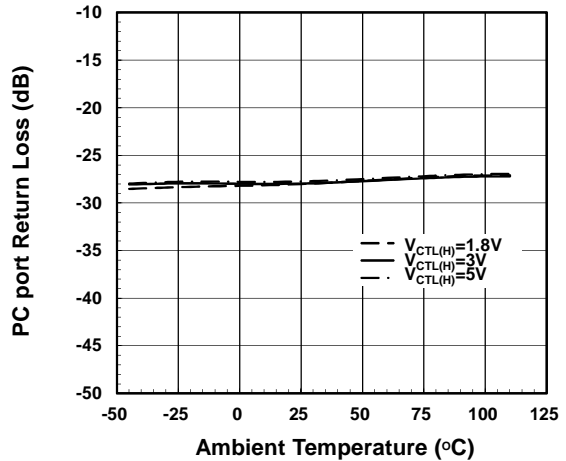

Return Loss vs Ambient Temperature

(f=5.9GHz, PC-P1 ON, $V_{CTL(L)}=0$)

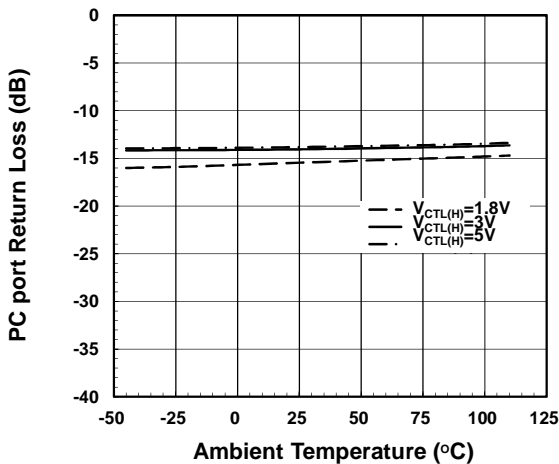

Return Loss vs Ambient Temperature

(f=8.5GHz, PC-P1 ON, $V_{CTL(L)}=0$)

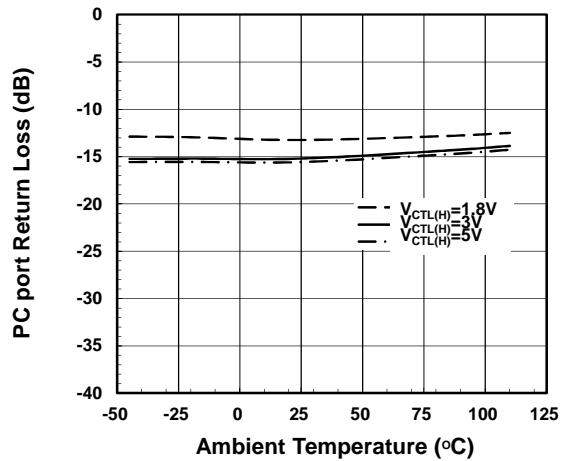

Automotive NJG1801AKGC-A

■ ELECTRICAL CHARACTERISTICS (With application circuit, loss of external circuit are excluded.)

P-1dB vs Temperature

(f=2.5GHz, $V_{CTL(L)}=0V$, PC-P1 ON)

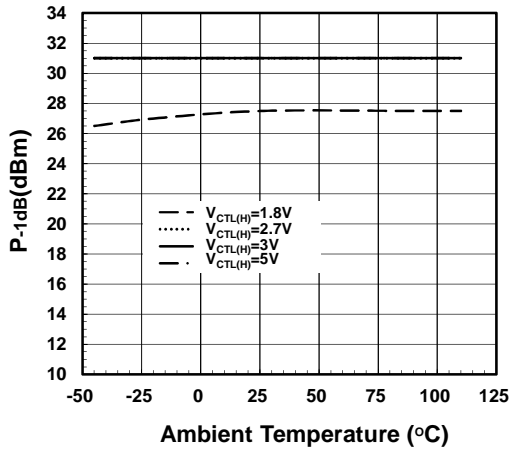

P-1dB vs Temperature

(f=5.9GHz, $V_{CTL(L)}=0V$, PC-P1 ON)

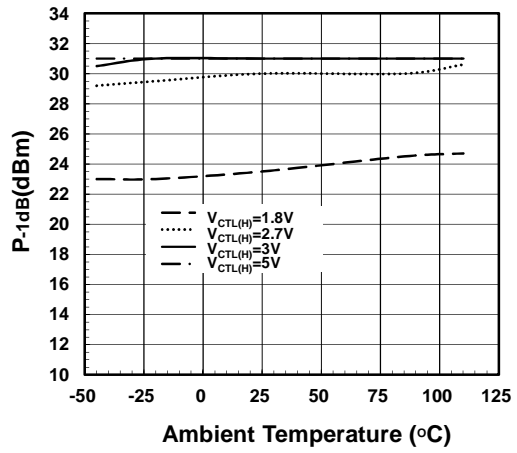

P-1dB vs Temperature

(f=8.5GHz, $V_{CTL(L)}=0V$, PC-P1 ON)

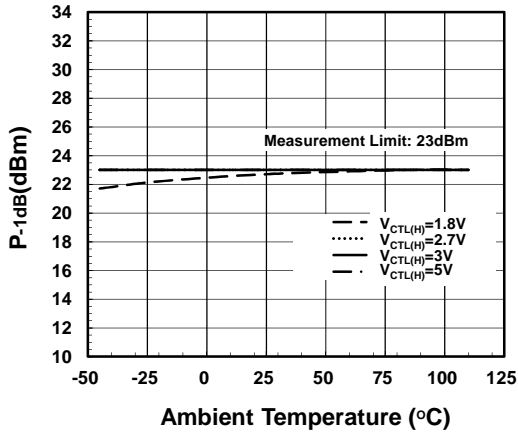

Automotive NJG1801AKGC-A

APPLICATION CIRCUIT

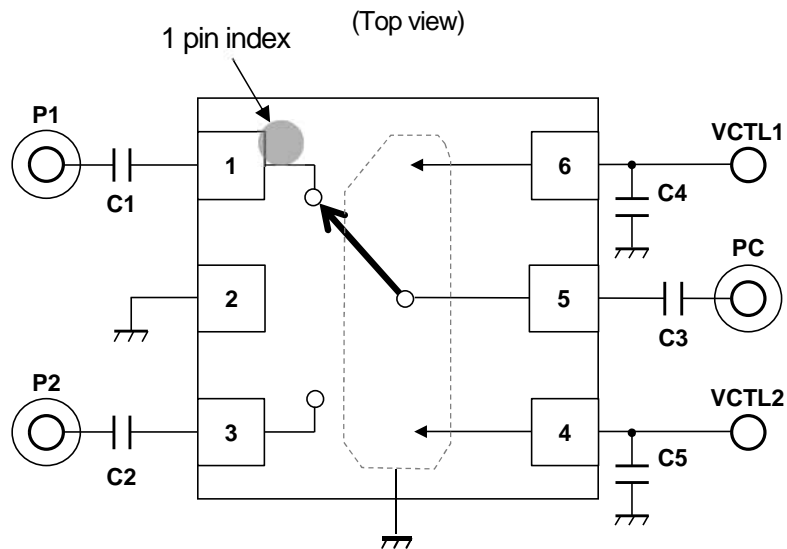

PARTS LIST

Part ID	Value	Notes
C1 to C3	1000 pF	GRM0335C1E102GA01D
C4 to C5	10 pF	GRM0335C1E100GA01D

RECOMMENDED PCB DESIGN

(Top View)

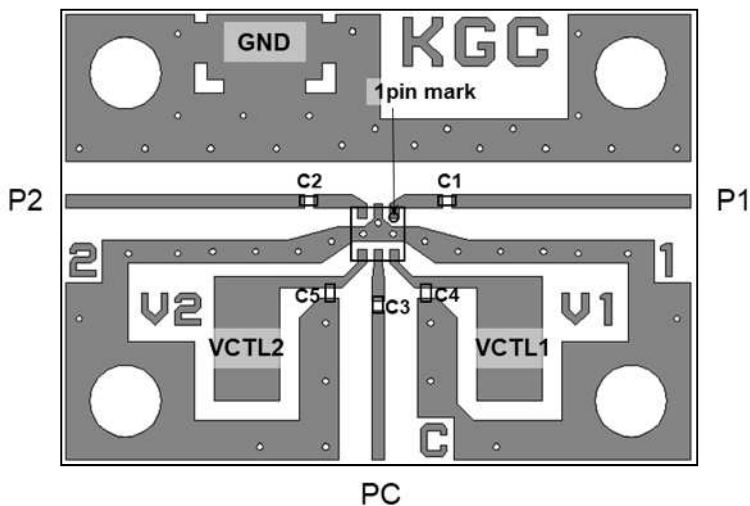

PCB (FR-4):

$t = 0.2 \text{ mm}$

MICROSTRIP LINE WIDTH = 0.4 mm ($Z_0 = 50 \Omega$)

PCB SIZE = $19.4 \times 14.0 \text{ mm}$

Losses of PCB, capacitors and connectors, $T_a = +25^\circ\text{C}$

Frequency [GHz]	Loss [dB]
0.3	0.14
2.4	0.38
2.5	0.39
4.9	0.59
5.9	0.73
8.5	0.91

<PCB LAYOUT GUIDELINE>

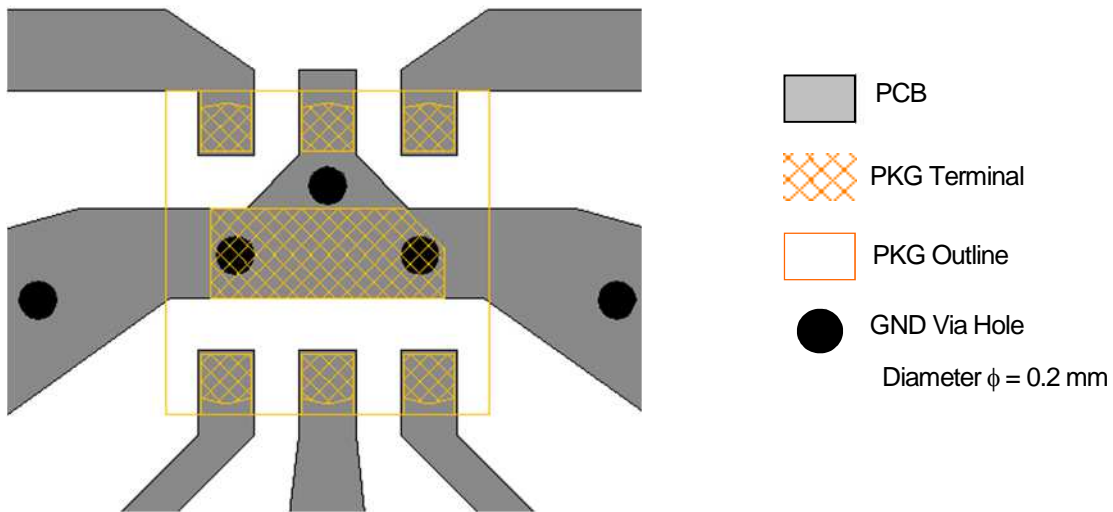

PRECAUTIONS

- [1] The DC blocking capacitors (C1, C2, C3) should be placed at RF terminals. Please choose appropriate capacitance value at the application frequency.
- [2] For avoiding the degradation of RF performance, the bypass capacitors (C4, C5) should be placed as close as possible to VCTL terminals.
- [3] For good RF performance, GND terminal must be connected to PCB ground plane of substrate, and through -holes should be placed near the IC.
- [4] For good RF performance, exposed pad should be connected to PCB ground plane of substrate, and through -holes should be placed near the IC.

Automotive NJG1801AKGC-A

■ HANDLING PRECAUTIONS

PIN NO.	SYMBOL	ESD RATINGS		
		Human Body Model ⁽¹⁾		Charged Device Model ⁽²⁾
Common terminal		Ground	I/O	
1	P1	Class 1C	Class 2	Class C6
2	GND	COM.	-	Class C6
3	P2	Class 1C	Class 2	Class C6
4	VCTL2	Class 0B	Class 0B	Class C6
5	PC	Class 2	Class 2	Class C6
6	VCTL1	Class 0B	Class 0B	Class C6

(1): According to JEDEC JS-001



(2): According to JEDEC JS-002

CAUTION: This product may be damaged with electric static discharge (ESD) or spike voltage. Please handle with care to avoid these damages.

■ RECOMMENDED FOOTPRINT PATTERN (ESON6-GC PACKAGE) <Reference>

Package: 1.6 mm x 1.6 mm

Pin pitch: 0.5 mm

-  : Land
-  :Mask (Open area) *Metal mask thickness : 100 μm
-  :Resist(Open area)

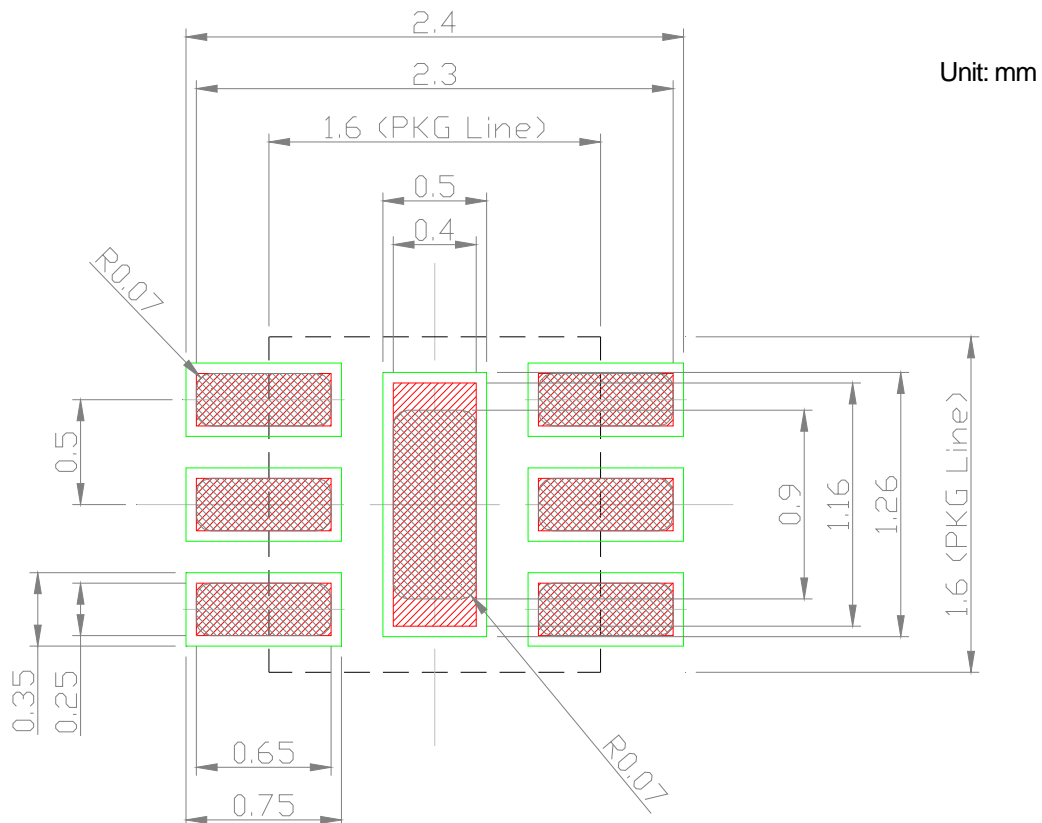

Automotive NJG1801AKGC-A

■ PACKAGE OUTLINE (ESON6-GC)

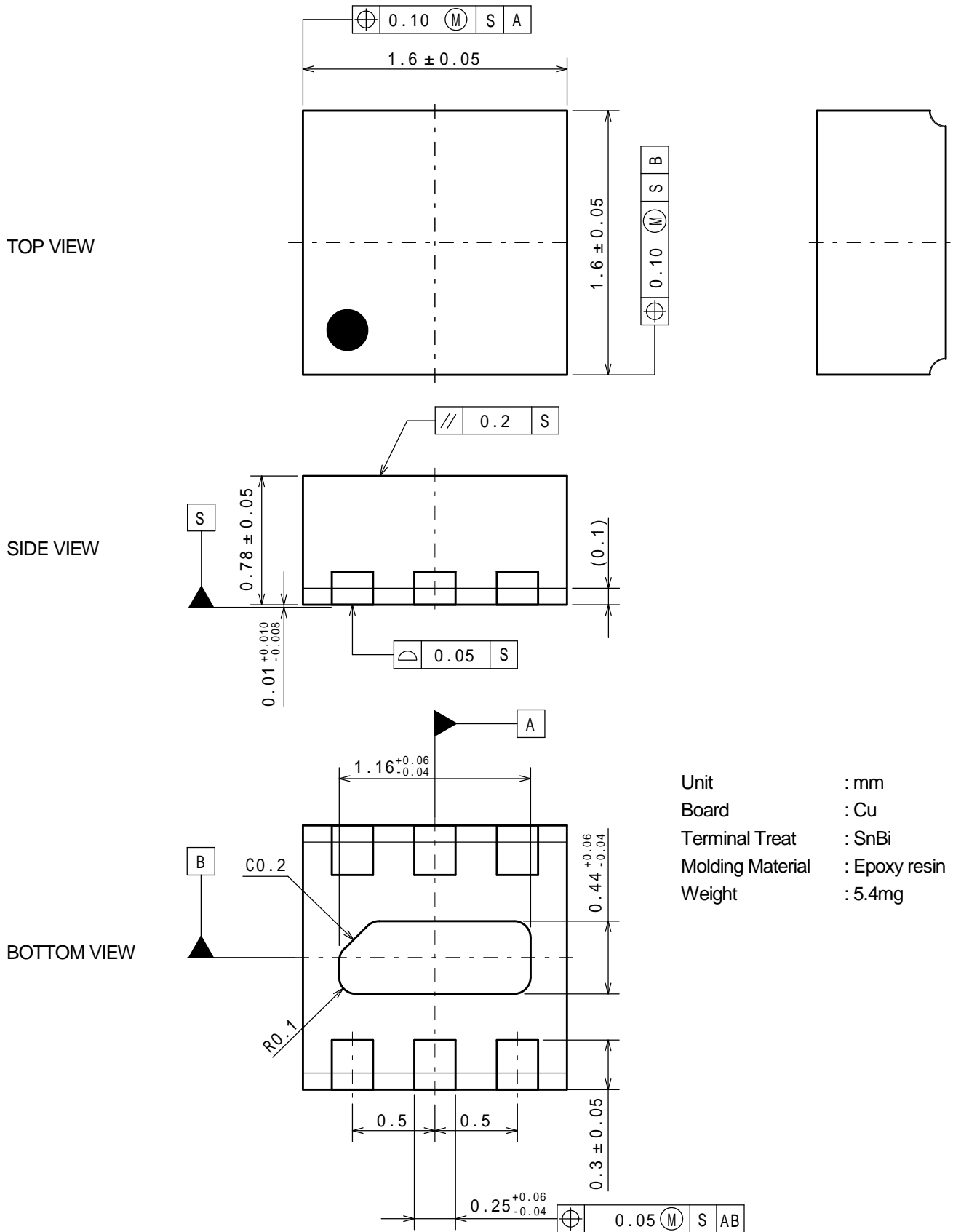

Automotive NJG1801AKGC-A

PACKING SPECIFICATION (ESON6-GC)

UNIT: mm

TAPING DIMENSIONS

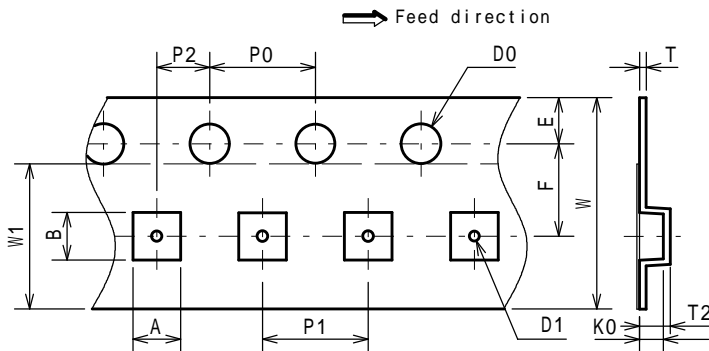

SYMBOL	DIMENSION	REMARKS
A	1.80 ± 0.05	BOTTOM DIMENSION
B	1.80 ± 0.05	BOTTOM DIMENSION
D0	1.5 ^{+0.1} ₀	
D1	0.5 ^{+0.1} ₀	
E	1.75 ± 0.1	
F	3.5 ± 0.05	
P0	4.0 ± 0.1	
P1	4.0 ± 0.1	
P2	2.0 ± 0.05	
T	0.25 ± 0.05	
T2	1.28 ± 0.07	
K0	0.93 ± 0.05	
W	8.0 ^{+0.3} _{-0.1}	
W1	5.5	THICKNESS 0.1max

REEL DIMENSIONS

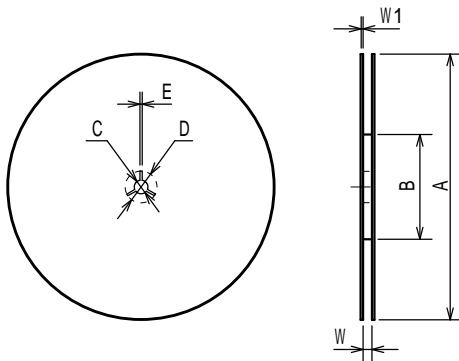

SYMBOL	DIMENSION
A	180 ⁰ _{-1.5}
B	60 ⁺¹ ₀
C	13 ± 0.2
D	21 ± 0.8
E	2 ± 0.5
W	9 ^{+0.3} ₀
W1	1.2

TAPING STATE

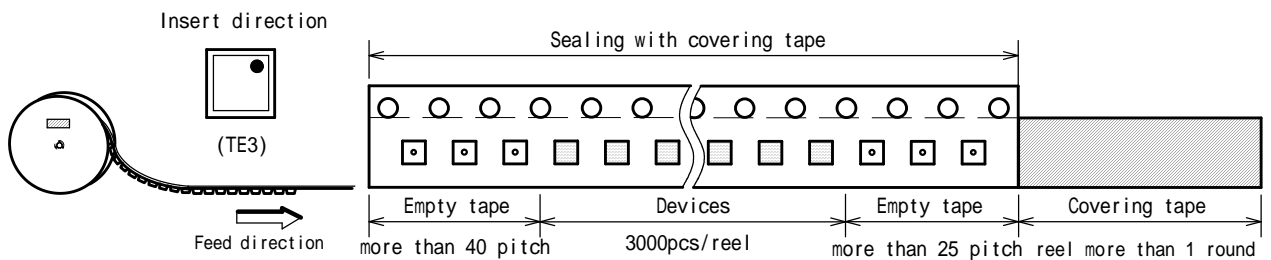

PACKING STATE

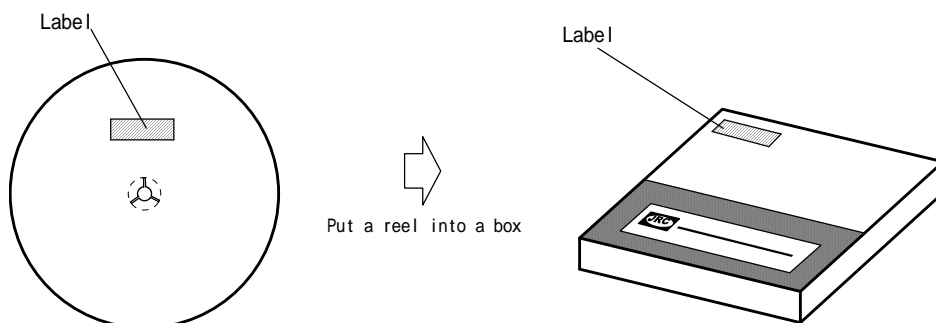

Automotive NJG1801AKGC-A

■ REVISION HISTORY

Date	Revision	Changes
17.Nov.2021	Ver.1.3	Revised ELECTRICAL CHARACTERISTICS 1 Revised RECOMMENDED PCB DESIGN
5.Nov.2021	Ver.1.2	Revised RECOMMENDED FOOTPRINT PATTERN
3.Sep.2021	Ver.1.1	Revised PARTS LIST
20.Aug.2020	Ver.1.0	New Release Automotive spec

1. The products and the product specifications described in this document are subject to change or discontinuation of production without notice for reasons such as improvement. Therefore, before deciding to use the products, please refer to our sales representatives for the latest information thereon.
2. The materials in this document may not be copied or otherwise reproduced in whole or in part without the prior written consent of us.
3. This product and any technical information relating thereto are subject to complementary export controls (so-called KNOW controls) under the Foreign Exchange and Foreign Trade Law, and related politics ministerial ordinance of the law. (Note that the complementary export controls are inapplicable to any application-specific products, except rockets and pilotless aircraft, that are insusceptible to design or program changes.) Accordingly, when exporting or carrying abroad this product, follow the Foreign Exchange and Foreign Trade Control Law and its related regulations with respect to the complementary export controls.
4. The technical information described in this document shows typical characteristics and example application circuits for the products. The release of such information is not to be construed as a warranty of or a grant of license under our or any third party's intellectual property rights or any other rights.
5. The products listed in this document are intended and designed for automotive applications. Those customers intending to use a product in an application requiring extreme quality and reliability, for example, in a highly specific application where the failure or misoperation of the product could result in human injury or death should first contact us.
 - Aerospace Equipment
 - Equipment Used in the Deep Sea
 - Power Generator Control Equipment (nuclear, steam, hydraulic, etc.)
 - Life Maintenance Medical Equipment
 - Fire Alarms / Intruder Detectors
 - Vehicle Control Equipment (airplane, railroad, ship, etc.)
 - Various Safety Devices
 - Traffic control system
 - Combustion equipment

In case your company desires to use this product for any applications other than general electronic equipment mentioned above, make sure to contact our company in advance. Note that the important requirements mentioned in this section are not applicable to cases where operation requirements such as application conditions are confirmed by our company in writing after consultation with your company.

6. We are making our continuous effort to improve the quality and reliability of our products, but semiconductor products are likely to fail with certain probability. In order to prevent any injury to persons or damages to property resulting from such failure, customers should be careful enough to incorporate safety measures in their design, such as redundancy feature, fire containment feature and fail-safe feature. We do not assume any liability or responsibility for any loss or damage arising from misuse or inappropriate use of the products.
7. The products have been designed and tested to function within controlled environmental conditions. Do not use products under conditions that deviate from methods or applications specified in this datasheet. Failure to employ the products in the proper applications can lead to deterioration, destruction or failure of the products. We shall not be responsible for any bodily injury, fires or accident, property damage or any consequential damages resulting from misuse or misapplication of the products.
8. **Quality Warranty**
 - 8-1. **Quality Warranty Period**
In the case of a product purchased through an authorized distributor or directly from us, the warranty period for this product shall be one (1) year after delivery to your company. For defective products that occurred during this period, we will take the quality warranty measures described in section 8-2. However, if there is an agreement on the warranty period in the basic transaction agreement, quality assurance agreement, delivery specifications, etc., it shall be followed.
 - 8-2. **Quality Warranty Remedies**
When it has been proved defective due to manufacturing factors as a result of defect analysis by us, we will either deliver a substitute for the defective product or refund the purchase price of the defective product.
Note that such delivery or refund is sole and exclusive remedies to your company for the defective product.
 - 8-3. **Remedies after Quality Warranty Period**
With respect to any defect of this product found after the quality warranty period, the defect will be analyzed by us. On the basis of the defect analysis results, the scope and amounts of damage shall be determined by mutual agreement of both parties. Then we will deal with upper limit in Section 8-2. This provision is not intended to limit any legal rights of your company.
9. Anti-radiation design is not implemented in the products described in this document.
10. The X-ray exposure can influence functions and characteristics of the products. Confirm the product functions and characteristics in the evaluation stage.
11. WLCSP products should be used in light shielded environments. The light exposure can influence functions and characteristics of the products under operation or storage.
12. Warning for handling Gallium and Arsenic (GaAs) products (Applying to GaAs MMIC, Photo Reflector). These products use Gallium (Ga) and Arsenic (As) which are specified as poisonous chemicals by law. For the prevention of a hazard, do not burn, destroy, or process chemically to make them as gas or power. When the product is disposed of, please follow the related regulation and do not mix this with general industrial waste or household waste.
13. Please contact our sales representatives should you have any questions or comments concerning the products or the technical information.



Nisshinbo Micro Devices Inc.

Official website

<https://www.nisshinbo-microdevices.co.jp/en/>

Purchase information

<https://www.nisshinbo-microdevices.co.jp/en/buy/>