

SP5T SWITCH GaAs MMIC

■ GENERAL DESCRIPTION

The NJG1665MD7 is a GaAs SP5T switch featured low insertion loss, high isolation and small size package, and suited for mobile terminal applications. The NJG1665MD7 switches a path between common RF port and five RF ports by three bit control signal from 1.3V of logical high voltage. In addition, this switch includes ESD protection circuits for good ESD tolerance. The NJG1665MD7 is available in a very small, lead-free, halogen-free, 1.6mm x 1.6mm x 0.397 mm, 14-pin EQFN14-D7 package.

■ PACKAGE OUTLINE

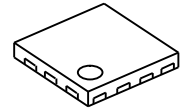

NJG1665MD7

■ APPLICATIONS

Multi-mode LTE, UMTS, CDMA and GSM applications
 Receive system, RX path, and Diversity antenna applications
 Mobile phone, Tablet PC, Data card, Modem and Router applications

■ FEATURES

- Low control voltage $V_{CTL(H)} = +1.3V$ min
- Low operating voltage $V_{DD} = +2.0 \sim +4.5V$
- Low insertion loss 0.40 dB typ. @f=1.0GHz, $P_{IN}=23dBm$
- 0.50 dB typ. @f=2.0GHz, $P_{IN}=23dBm$
- 0.60 dB typ. @f=2.5GHz, $P_{IN}=23dBm$
- High ESD tolerance On-chip ESD protection circuit
- Small and thin package EQFN14-D7 (package size: 1.6mm x 1.6mm x 0.397mm typ.)
- Lead -free and halogen-free

■ PIN CONFIGURATION

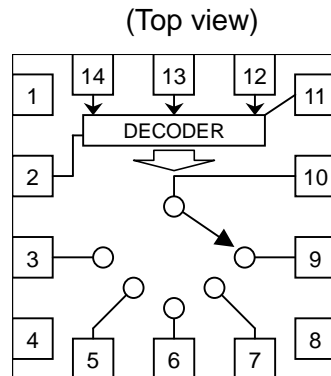

Pin connection

- | | |
|--------|----------|
| 1. GND | 8. GND |
| 2. VDD | 9. P1 |
| 3. P5 | 10. PC |
| 4. GND | 11. GND |
| 5. P4 | 12. CTL3 |
| 6. P3 | 13. CTL2 |
| 7. P2 | 14. CTL1 |

■ TRUTH TABLE

PATH	CTL1	CTL2	CTL3
PC-P1	L	H	L
PC-P2	H	H	L
PC-P3	L	H	H
PC-P4	H	H	H
PC-P5	X	L	L

"H"... $V_{CTL(H)}$, "L"... $V_{CTL(L)}$, "X" ...Do not care.

NOTE: The information on this datasheet is subject to change without notice

ABSOLUTE MAXIMUM RATINGS

(T_a=+25°C, Z_s=Z_i=50Ω)

PARAMETER	SYMBOL	CONDITIONS	RATINGS	UNITS
RF input power	P _{IN}	V _{DD} =2.7V, V _{CTL} =0V / 1.8 V	30	dBm
Supply voltage	V _{DD}	VDD terminal	5.0	V
Control voltage	V _{CTL}	CTL1~3 terminals	5.0	V
Power dissipation	P _D	Four-layer FR4 PCB with through-hole (74.2mmx74.2mm), T _j =150°C	1300	mW
Operating temp.	T _{opr}		-40~+85	°C
Storage temp.	T _{stg}		-55~+150	°C

ELECTRICAL CHARACTERISTICS (DC)

(General conditions: V_{DD}=2.7 V, V_{CTL(L)}=0 V, V_{CTL(H)}=1.8 V, Z_s=Z_i=50 Ω, T_a=+25°C, with application circuit)

PARAMETERS	SYMBOL	CONDITIONS	MIN	TYP	MAX	UNITS
Supply voltage	V _{DD}		2.0	2.7	4.5	V
Operating current	I _{DD}	f=2.0GHz, P _{IN} =23 dBm		45	100	μA
Control voltage (LOW)	V _{CTL(L)}		0	-	0.4	V
Control voltage (HIGH)	V _{CTL(H)}		1.3	1.8	4.5	V
Control Current	I _{CTL}		-	5	10	μA

ELECTRICAL CHARACTERISTICS (RF)

(General conditions: V_{DD}=2.7 V, V_{CTL(L)}=0 V, V_{CTL(H)}=1.8 V, Z_s=Z_i=50 Ω, T_a=+25°C, with application circuit)

PARAMETERS	SYMBOL	CONDITIONS	MIN	TYP	MAX	UNITS
Insertion Loss1	LOSS1	f=1.0 GHz, P _{IN} =23 dBm	-	0.40	0.60	dB
Insertion Loss2	LOSS2	f=2.0 GHz, P _{IN} =23 dBm	-	0.50	0.70	dB
Insertion Loss3	LOSS3	f=2.5 GHz, P _{IN} =23 dBm	-	0.60	0.80	dB
Isolation1	ISL1	f=1.0 GHz, P _{IN} =23 dBm	25	29	-	dB
Isolation2	ISL2	f=2.0 GHz, P _{IN} =23 dBm	20	23	-	dB
Isolation3	ISL3	f=2.5 GHz, P _{IN} =23 dBm	18	21	-	dB
Input Power at 0.2dB Compression Point	P _{-0.2dB}	f=2.0 GHz	26	29	-	dBm
VSWR	VSWR	f=2.0 GHz, ON state		1.2	1.5	
Switching Time	T _{SW}	50% CTL to 10%/90% RF		1	5	μs

■ TERMINAL INFORMATION

No.	SYMBOL	DESCRIPTION
1	GND	Ground terminal. Connect to the PCB ground plane.
2	VDD	Power supply input. This terminal should be connected to GND via a bypass capacitor.
3	P5	RF input / output port. External capacitor is required to block the DC bias voltage of internal circuit.
4	GND	Ground terminal. Connect to the PCB ground plane.
5	P4	RF input / output port. External capacitor is required to block the DC bias voltage of internal circuit.
6	P3	RF input / output port. External capacitor is required to block the DC bias voltage of internal circuit.
7	P2	RF input / output port. External capacitor is required to block the DC bias voltage of internal circuit.
8	GND	Ground terminal. Connect to the PCB ground plane.
9	P1	RF input / output port. External capacitor is required to block the DC bias voltage of internal circuit.
10	PC	Common RF input / output port. External capacitor is required to block the DC bias voltage of internal circuit.
11	GND	Ground terminal. Connect to the PCB ground plane.
12	CTL3	Control port. "High level" is DC +1.3V~4.5V, "Low level" is DC 0~+0.4V.
13	CTL2	Control port. "High level" is DC +1.3V~4.5V, "Low level" is DC 0~+0.4V.
14	CTL1	Control port. "High level" is DC +1.3V~4.5V, "Low level" is DC 0~+0.4V.

ELECTRICAL CHARACTERISTICS (With Application circuit, Loss of external circuit are excluded)

Loss, ISL vs Frequency

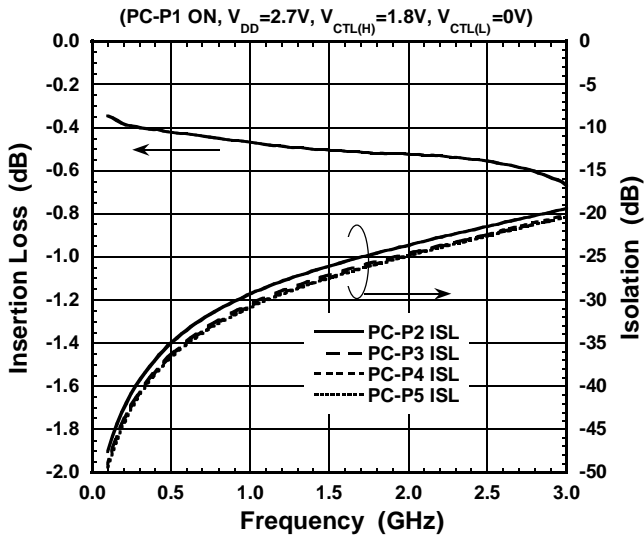

Loss, VSWR vs Frequency

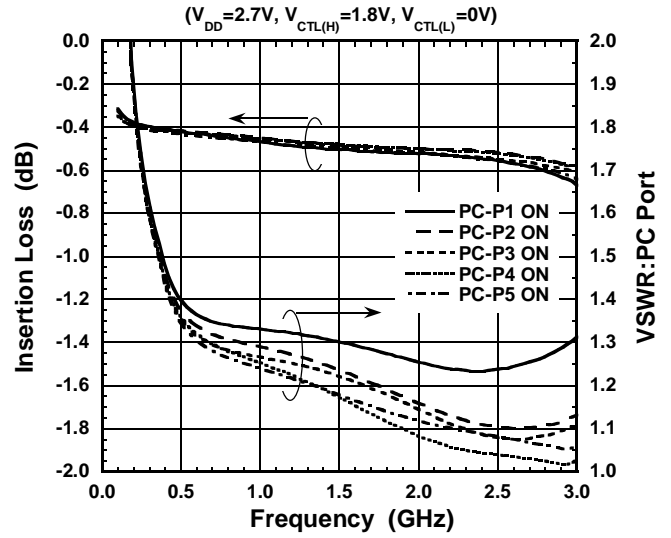

Output Power, I_{DD} vs Input Power

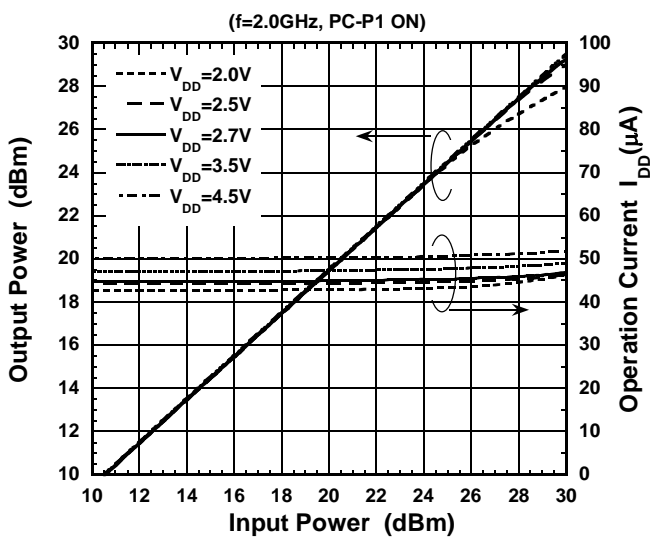

Loss, ISL vs Input Power

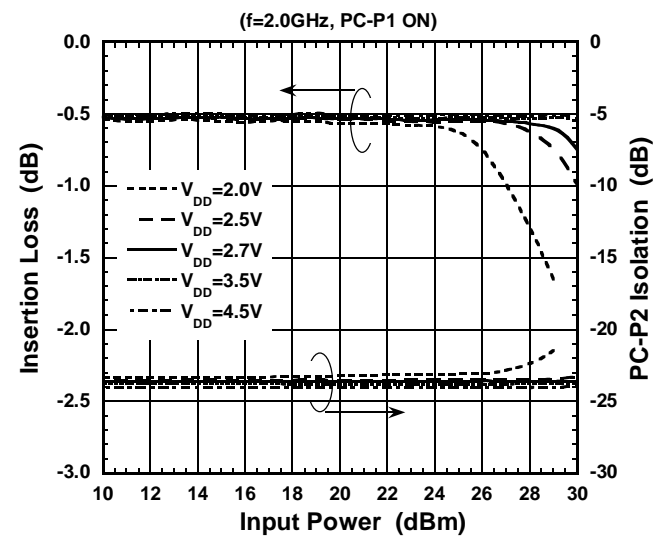

Switching Time

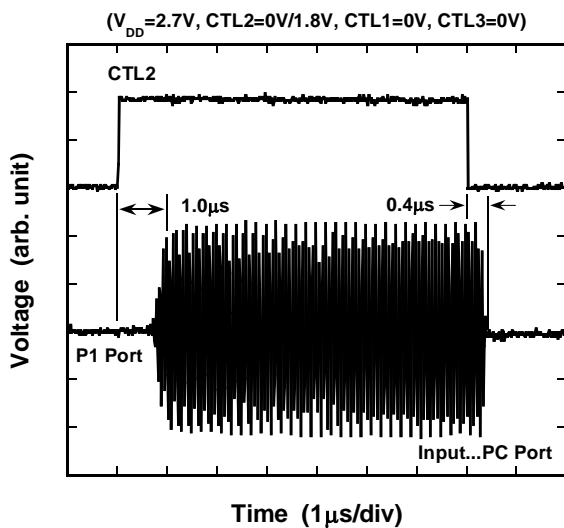

ELECTRICAL CHARACTERISTICS (With Application circuit, Loss of external circuit are excluded)

Operation Current vs Temperature

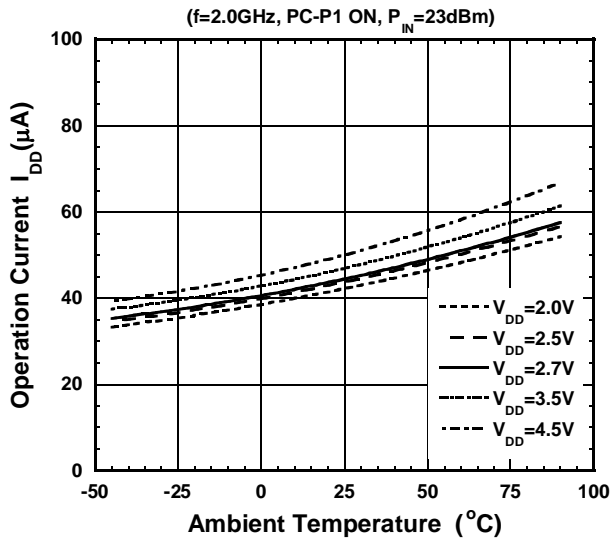

Control Current vs Temperature

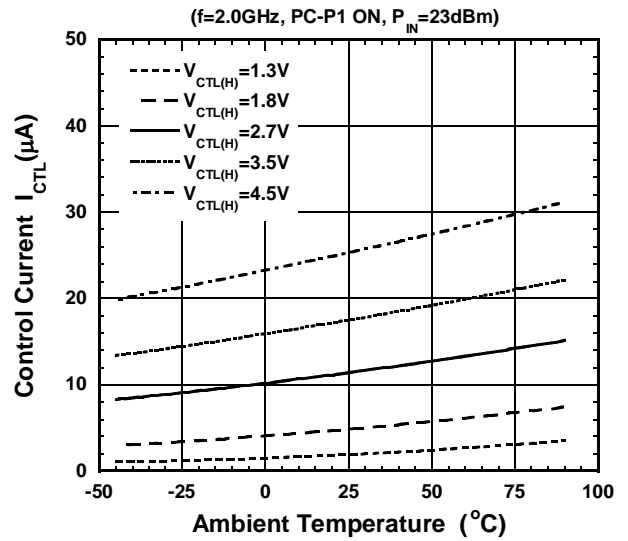

LOSS, ISL vs Temperature

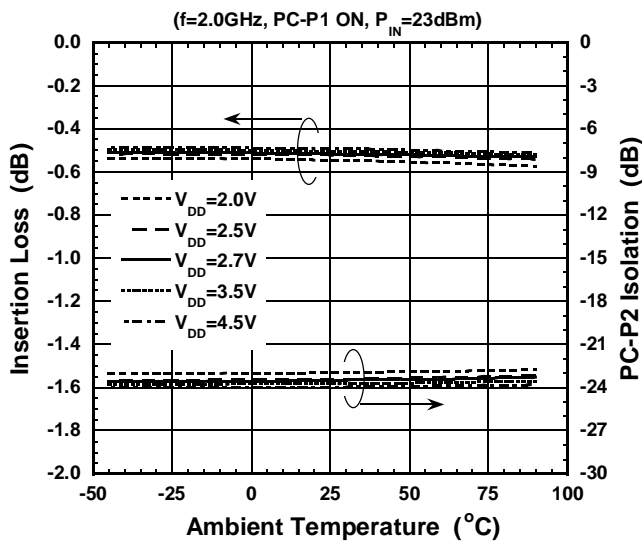

VSWR vs Temperature

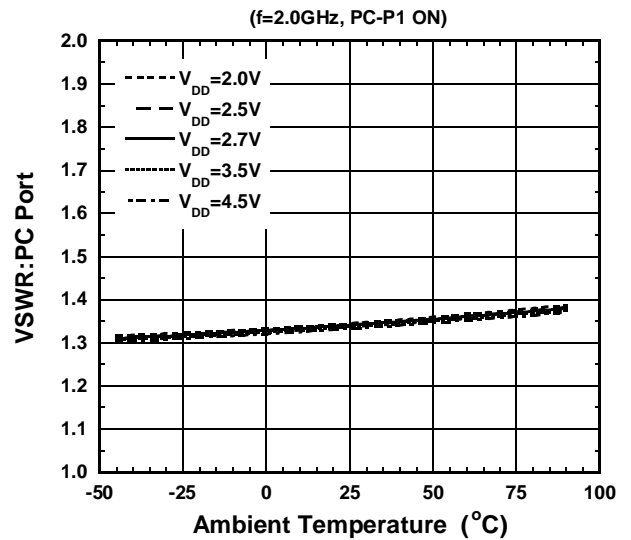

P_{-0.2dB} vs Temperature

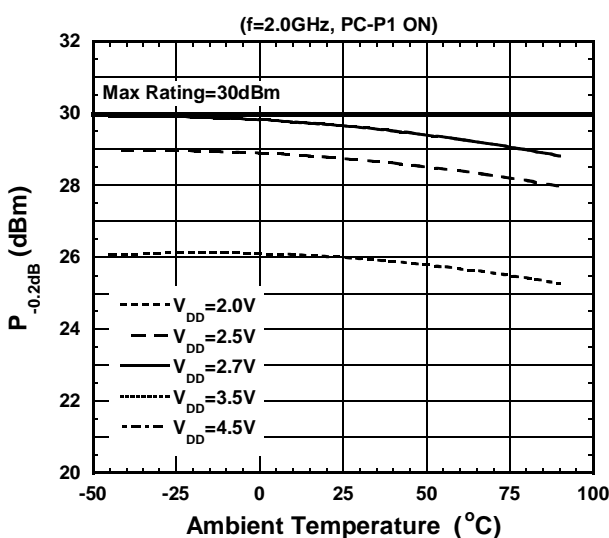

Switching Time vs Temperature

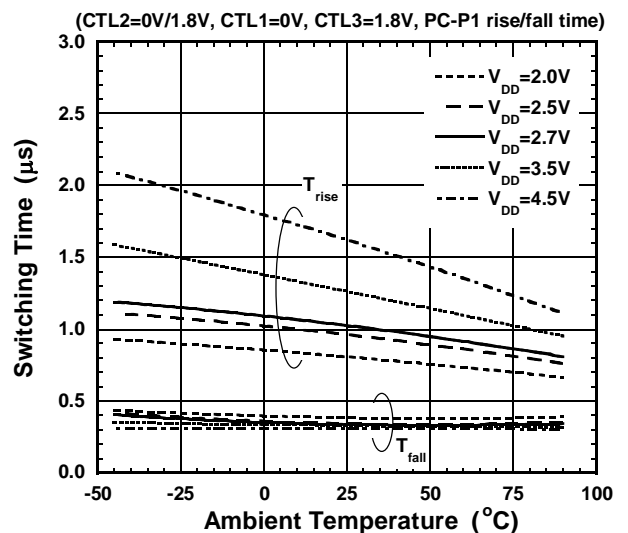

APPLICATION CIRCUIT

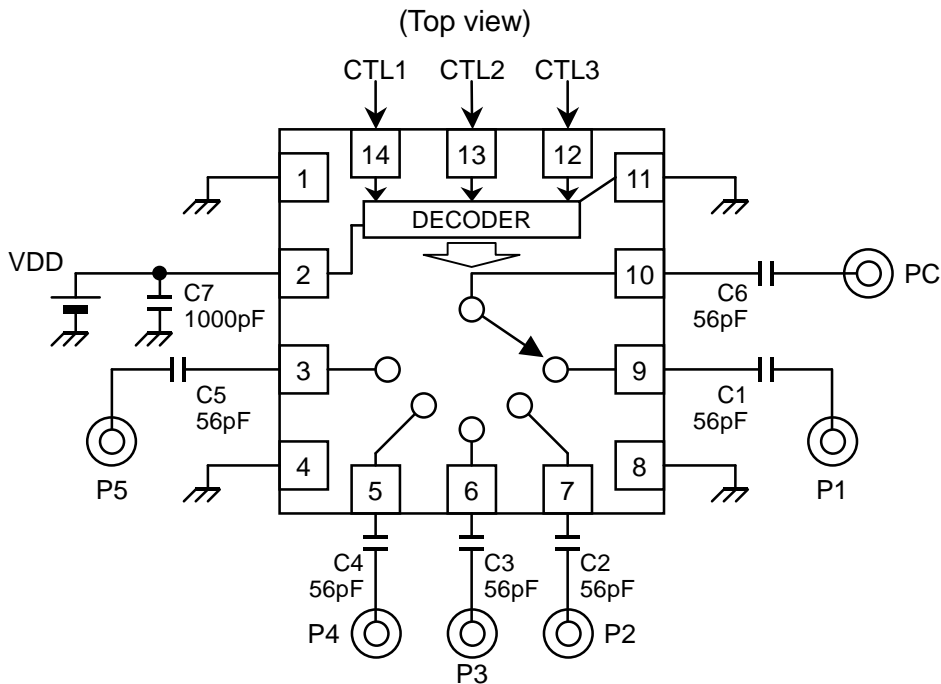

PARTS LIST

Part ID	Value	Notes
C1~C6	56pF	MURATA MFG (GRM15)
C7	1000pF	

TEST PCB LAYOUT

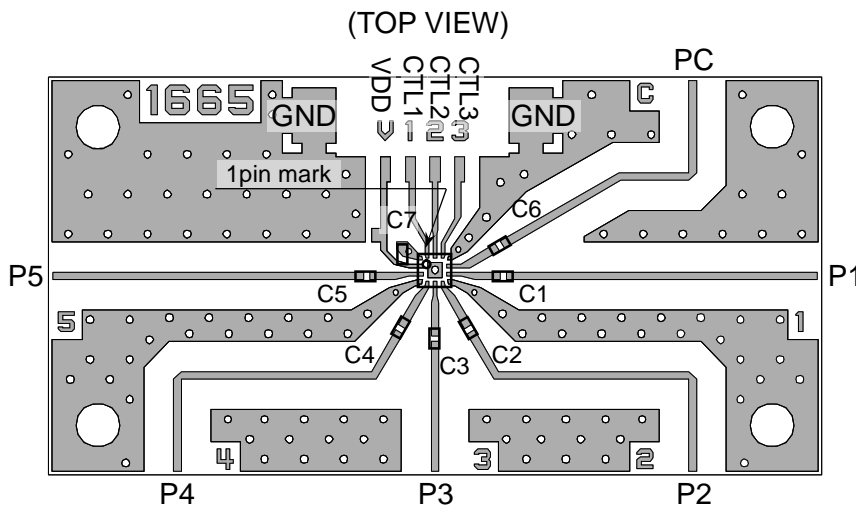

PCB SIZE=39.0 x 20.0mm
 PCB: FR-4, t=0.2mm
 CAPACITOR: size 1005
 STRIP LINE WIDTH=0.4mm

Losses of PCB and Connectors

Freq. (GHz)	Loss (dB)		
	PC-P1 PC-P5	PC-P2 PC-P4	PC-P3
1.0	0.41	0.43	0.36
2.0	0.62	0.65	0.52
2.5	0.74	0.79	0.61

PRECAUTIONS

- [1] The DC blocking capacitors should be placed at RF terminal of P1, P2, P3, P4, P5 and PC. Please choose appropriate capacitance values to the application frequency.
- [2] The bypass capacitor (C7) should be placed as close as possible to VDD terminal.
- [3] For good RF performance, all GND terminals are should be connected to PCB ground plane.

PACKAGE OUTLINE (EQFN14-D7)

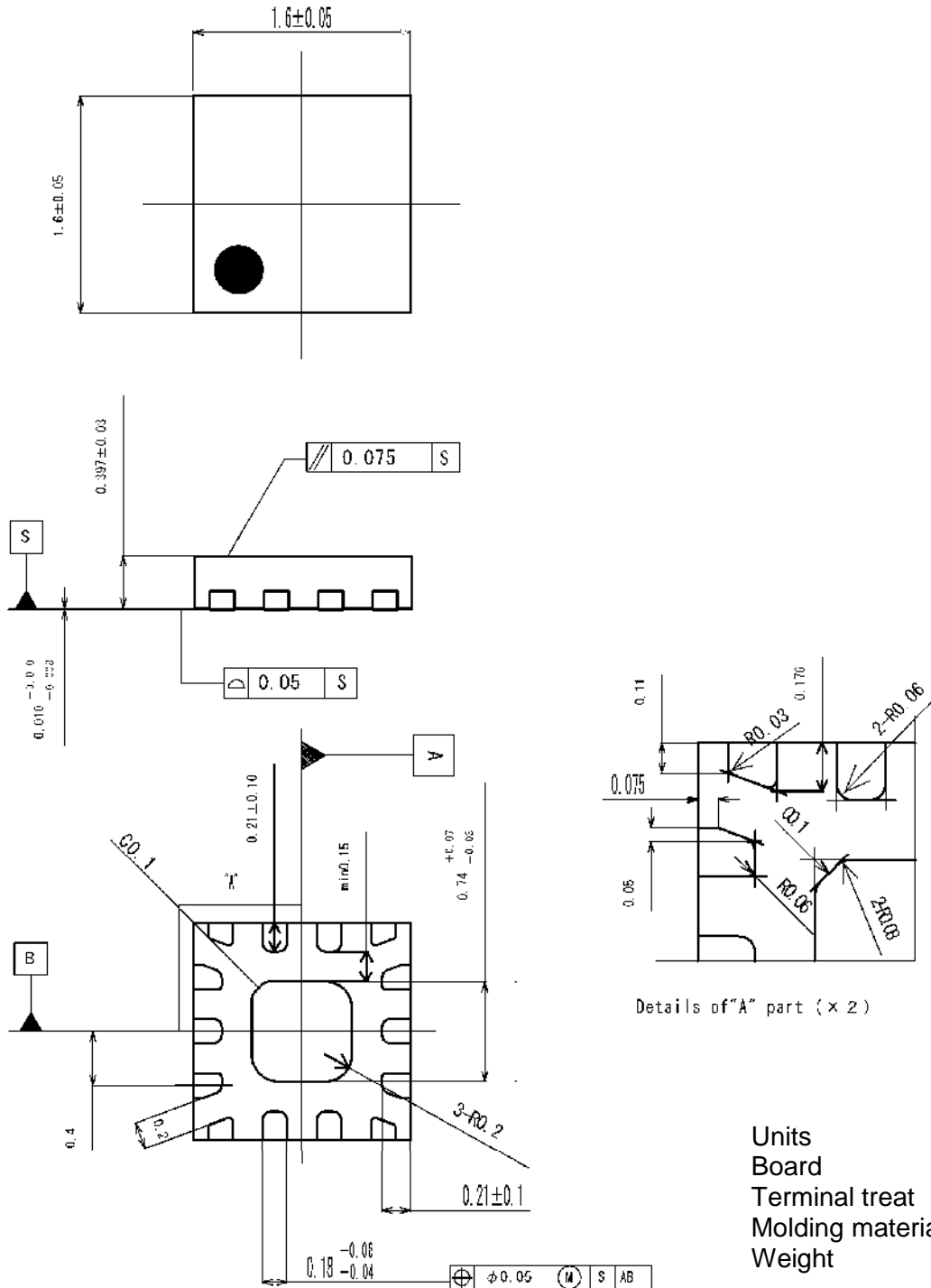

Cautions on using this product

- This product contains Gallium-Arsenide (GaAs) which is a harmful material.
- Do NOT eat or put into mouth.
 - Do NOT dispose in fire or break up this product.
 - Do NOT chemically make gas or powder with this product.
 - To waste this product, please obey the relating law of your country.

[CAUTION]

The specifications on this databook are only given for information, without any guarantee as regards either mistakes or omissions. The application circuits in this databook are described only to show representative usages of the product and not intended for the guarantee or permission of any right including the industrial rights.

This product may be damaged with electric static discharge (ESD) or spike voltage. Please handle with care to avoid these damages.

1. The products and the product specifications described in this document are subject to change or discontinuation of production without notice for reasons such as improvement. Therefore, before deciding to use the products, please refer to our sales representatives for the latest information thereon.
2. The materials in this document may not be copied or otherwise reproduced in whole or in part without the prior written consent of us.
3. This product and any technical information relating thereto are subject to complementary export controls (so-called KNOW controls) under the Foreign Exchange and Foreign Trade Law, and related politics ministerial ordinance of the law. (Note that the complementary export controls are inapplicable to any application-specific products, except rockets and pilotless aircraft, that are insusceptible to design or program changes.) Accordingly, when exporting or carrying abroad this product, follow the Foreign Exchange and Foreign Trade Control Law and its related regulations with respect to the complementary export controls.
4. The technical information described in this document shows typical characteristics and example application circuits for the products. The release of such information is not to be construed as a warranty of or a grant of license under our or any third party's intellectual property rights or any other rights.
5. The products listed in this document are intended and designed for use as general electronic components in standard applications (office equipment, telecommunication equipment, measuring instruments, consumer electronic products, amusement equipment etc.). Those customers intending to use a product in an application requiring extreme quality and reliability, for example, in a highly specific application where the failure or misoperation of the product could result in human injury or death should first contact us.
 - Aerospace Equipment
 - Equipment Used in the Deep Sea
 - Power Generator Control Equipment (nuclear, steam, hydraulic, etc.)
 - Life Maintenance Medical Equipment
 - Fire Alarms / Intruder Detectors
 - Vehicle Control Equipment (automotive, airplane, railroad, ship, etc.)
 - Various Safety Devices
 - Traffic control system
 - Combustion equipment

In case your company desires to use this product for any applications other than general electronic equipment mentioned above, make sure to contact our company in advance. Note that the important requirements mentioned in this section are not applicable to cases where operation requirements such as application conditions are confirmed by our company in writing after consultation with your company.

6. We are making our continuous effort to improve the quality and reliability of our products, but semiconductor products are likely to fail with certain probability. In order to prevent any injury to persons or damages to property resulting from such failure, customers should be careful enough to incorporate safety measures in their design, such as redundancy feature, fire containment feature and fail-safe feature. We do not assume any liability or responsibility for any loss or damage arising from misuse or inappropriate use of the products.
7. The products have been designed and tested to function within controlled environmental conditions. Do not use products under conditions that deviate from methods or applications specified in this datasheet. Failure to employ the products in the proper applications can lead to deterioration, destruction or failure of the products. We shall not be responsible for any bodily injury, fires or accident, property damage or any consequential damages resulting from misuse or misapplication of the products.
8. **Quality Warranty**
 - 8-1. **Quality Warranty Period**

In the case of a product purchased through an authorized distributor or directly from us, the warranty period for this product shall be one (1) year after delivery to your company. For defective products that occurred during this period, we will take the quality warranty measures described in section 8-2. However, if there is an agreement on the warranty period in the basic transaction agreement, quality assurance agreement, delivery specifications, etc., it shall be followed.
 - 8-2. **Quality Warranty Remedies**

When it has been proved defective due to manufacturing factors as a result of defect analysis by us, we will either deliver a substitute for the defective product or refund the purchase price of the defective product.

Note that such delivery or refund is sole and exclusive remedies to your company for the defective product.
 - 8-3. **Remedies after Quality Warranty Period**

With respect to any defect of this product found after the quality warranty period, the defect will be analyzed by us. On the basis of the defect analysis results, the scope and amounts of damage shall be determined by mutual agreement of both parties. Then we will deal with upper limit in Section 8-2. This provision is not intended to limit any legal rights of your company.
9. Anti-radiation design is not implemented in the products described in this document.
10. The X-ray exposure can influence functions and characteristics of the products. Confirm the product functions and characteristics in the evaluation stage.
11. WLCSP products should be used in light shielded environments. The light exposure can influence functions and characteristics of the products under operation or storage.
12. Warning for handling Gallium and Arsenic (GaAs) products (Applying to GaAs MMIC, Photo Reflector). These products use Gallium (Ga) and Arsenic (As) which are specified as poisonous chemicals by law. For the prevention of a hazard, do not burn, destroy, or process chemically to make them as gas or power. When the product is disposed of, please follow the related regulation and do not mix this with general industrial waste or household waste.
13. Please contact our sales representatives should you have any questions or comments concerning the products or the technical information.



Nisshinbo Micro Devices Inc.

Official website

<https://www.nisshinbo-microdevices.co.jp/en/>

Purchase information

<https://www.nisshinbo-microdevices.co.jp/en/buy/>