

SP3T SWITCH GaAs MMIC

GENERAL DESCRIPTION

NJG1650HB6 is a SP3T switch IC featured low insertion loss, high isolation and small size package.

This switch is suitable for W-LAN, Bluetooth, and sub-microwave applications.

A small and thin package of USB8-B6 is adopted.

PACKAGE OUTLINE

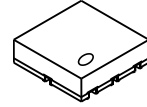

NJG1650HB6

APPLICATIONS

- LTE and 3G applications
- WLAN and Blue-tooth applications
- Receive system, RX path, and Diversity antenna applications
- Mobile phone, Tablet PC, Data card, Modem and Router applications

FEATURES

- Control voltage range +2.0~+5.0V
- Low insertion loss
 - 0.38dB typ. @f=1.0GHz, P_{IN}=23dBm, V_{CTL(H)}=2.7V
 - 0.42dB typ. @f=2.0GHz, P_{IN}=23dBm, V_{CTL(H)}=2.7V
 - 0.45dB typ. @f=2.5GHz, P_{IN}=23dBm, V_{CTL(H)}=2.7V
- High isolation 21dB typ. @f=2.5GHz, P_{IN}=23dBm, V_{CTL(H)}=2.7V
- Input power at 0.2dB compression point 28dBm typ. @f=2.5GHz, V_{CTL(H)}=2.7V
- Low current consumption 5μA typ. @ V_{CTL(H)}=2.7V
- Small & thin package USB8-B6 (package Size: 1.5 x 1.5 x 0.55mm typ.)

PIN CONFIGURATION

USB8-B6 Type
(Top view)

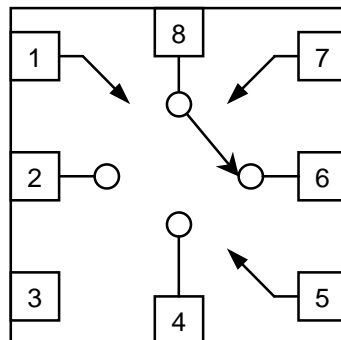

Pin connection

1. VCTL3
2. P3
3. GND
4. P2
5. VCTL2
6. P1
7. VCTL1
8. PC

TRUTH TABLE

“H”=V_{CTL(H)}, “L”=V_{CTL(L)}

VCTL1	VCTL2	VCTL3	PATH
H	L	L	PC-P1
L	H	L	PC-P2
L	L	H	PC-P3

NOTE: The information on this datasheet is subject to change without notice.

■ ABSOLUTE MAXIMUM RATINGS

(T_a=+25°C, Z_s=Z_l=50Ω)

PARAMETERS	SYMBOL	CONDITIONS	RATINGS	UNITS
Input Power	P _{IN}	V _{CTL(H)} =2.7V	30	dBm
Control Voltage	V _{CTL}		6.0	V
Power Dissipation	P _D	On PCB Board	150	mW
Operating Temp.	T _{opr}		-40~+85	°C
Storage Temp.	T _{stg}		-55~+150	°C

■ ELECTRICAL CHARACTERISTICS

(V_{CTL(L)}=0V, V_{CTL(H)}=2.7V, Z_s=Z_l=50Ω, T_a=+25°C, with application circuit)

PARAMETERS	SYMBOL	CONDITIONS	MIN	TYP	MAX	UNITS
Control voltage(LOW)	V _{CTL(L)}		-0.2	-	+0.2	V
Control voltage (HIGH)	V _{CTL(H)}		2.0	2.7	5.0	V
Control current	I _{CTL}		-	5	10	μA
Insertion Loss 1	LOSS1	f=1.0GHz, P _{IN} =23dBm	-	0.38	0.55	dB
Insertion Loss 2	LOSS2	f=2.0GHz, P _{IN} =23dBm	-	0.42	0.60	dB
Insertion Loss 3	LOSS3	f=2.5GHz, P _{IN} =23dBm	-	0.45	0.60	dB
Isolation 1	ISL1	f=1.0GHz, P _{IN} =23dBm	27	29	-	dB
Isolation 2	ISL2	f=2.0GHz, P _{IN} =23dBm	21	23	-	dB
Isolation 3	ISL3	f=2.5GHz, P _{IN} =23dBm	19	21	-	dB
Input power at 0.2dB compression point	P _{-0.2dB}	f=2.5GHz	25	28	-	dBm
VSWR (PC, P1, P2, P3)	VSWR	f=2.5GHz, On state	-	1.1	1.3	
Switching time	T _{sw}	50% CTL to 10/90% RF	-	150	500	ns

■ TERMINAL INFORMATION

No.	SYMBOL	DESCRIPTION
1	VCTL3	Control port. This port is set to $V_{CTL(H)}$ (+2.0~+5.0V) or $V_{CTL(L)}$ (-0.2~+0.2V). For good RF performance, please place a bypass capacitor between this port and GND, close to this port. Please choose optimum capacitance value from 10pF to 1000pF because this capacitor influences a switching time.
2	P3	RF port. This port is connected to PC port by control voltage of $V_{CTL(H)}$ at 1st pin, $V_{CTL(L)}$ at 5th and 7th pins. In order to block DC bias voltage of internal circuit, an external capacitor is required.
3	GND	Ground terminal. Please connect this terminal with ground plane as close as possible for good RF performance.
4	P2	RF port. This port is connected to PC port by control voltage of $V_{CTL(H)}$ at 5th pin, $V_{CTL(L)}$ at 1st and 7th pins. In order to block DC bias voltage of internal circuit, an external capacitor is required.
5	VCTL2	Control port. This port is set to $V_{CTL(H)}$ (+2.0~+5.0V) or $V_{CTL(L)}$ (-0.2~+0.2V). For good RF performance, please place a bypass capacitor between this port and GND, close to this port. Please choose optimum capacitance value from 10pF to 1000pF because this capacitor influences a switching time.
6	P1	RF port. This port is connected to PC port by control voltage of $V_{CTL(H)}$ at 7th pin, $V_{CTL(L)}$ at 1st and 5th pins. In order to block DC bias voltage of internal circuit, an external capacitor is required.
7	VCTL1	Control port. This port is set to $V_{CTL(H)}$ (+2.0~+5.0V) or $V_{CTL(L)}$ (-0.2~+0.2V). For good RF performance, please place a bypass capacitor between this port and GND, close to this port. Please choose optimum capacitance value from 10pF to 1000pF because this capacitor influences a switching time.
8	PC	Common RF port. This PC port is connected with either of P1, P2 and P3 by logical control voltage of VCTL1 to 3. In order to block DC bias voltage of internal circuit, an external capacitor is required.

■ ELECTRICAL CHARACTERISTICS (With Application circuit, Loss of external circuit are excluded)

Insertion Loss, Isolation vs Frequency

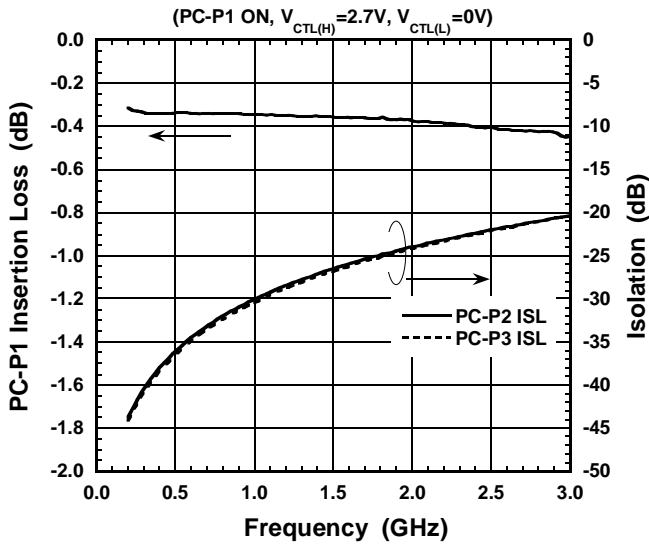

Insertion Loss, Isolation vs Frequency

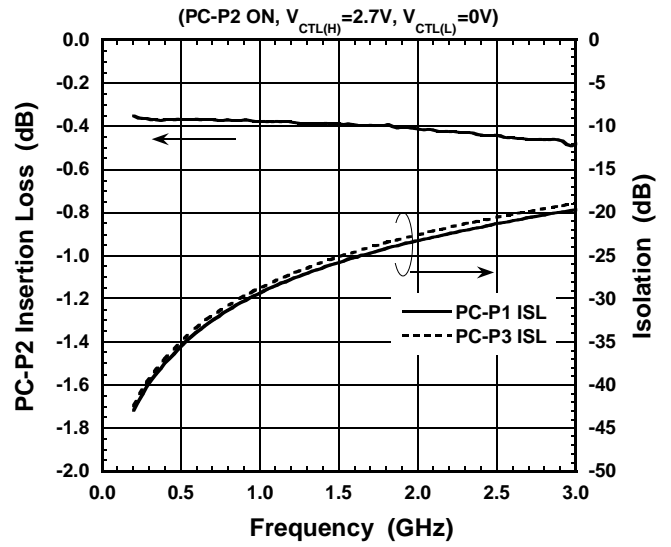

Insertion Loss, Isolation vs Frequency

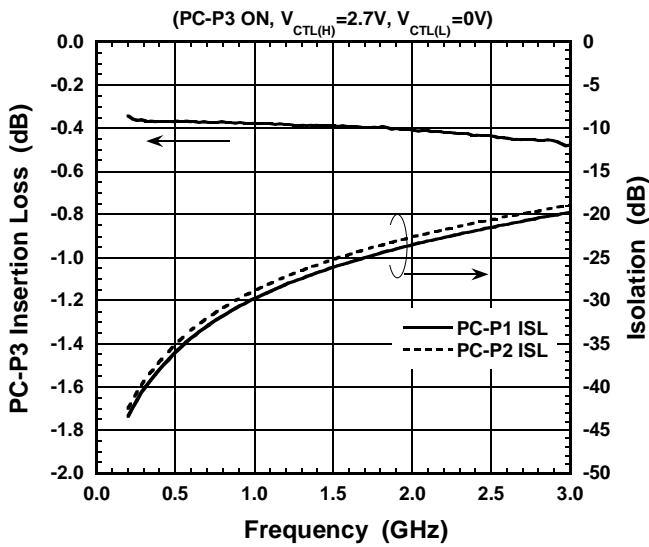

VSWR vs Frequency

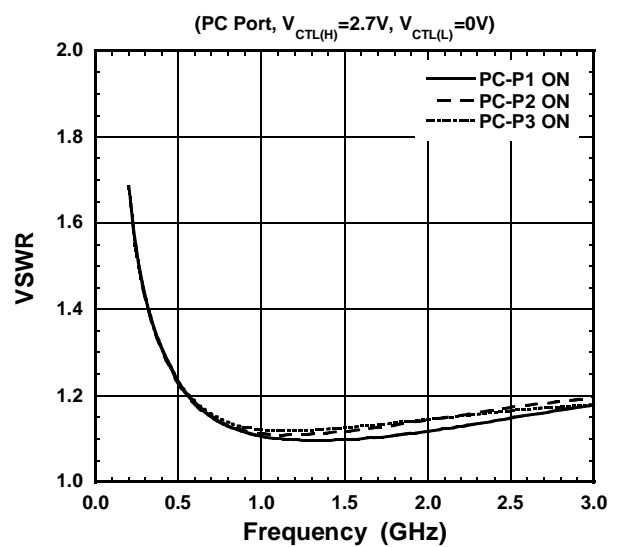

■ ELECTRICAL CHARACTERISTICS (With Application circuit, Loss of external circuit are excluded)

Output Power, I_{CTL} vs Input Power

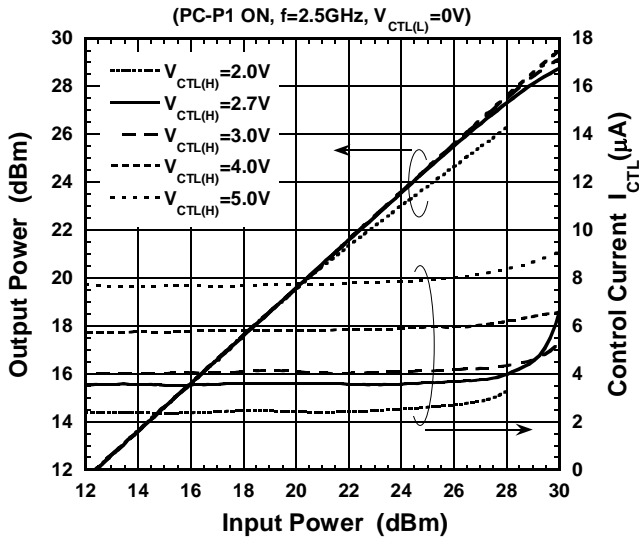

Insertion Loss, Isolation vs Input Power

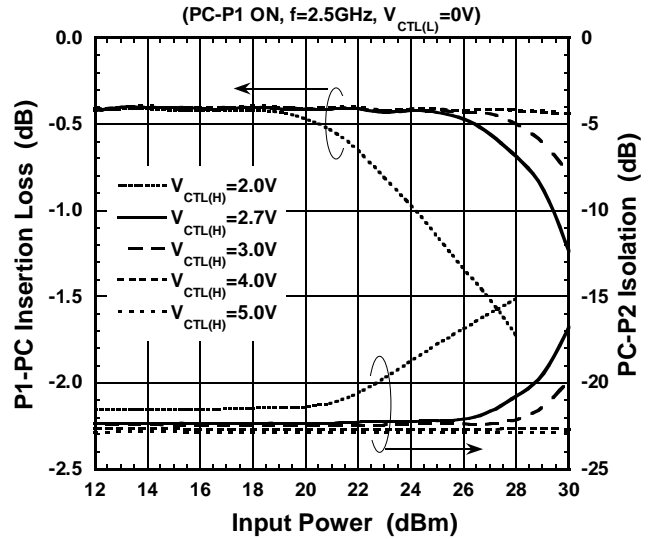

Switching Time

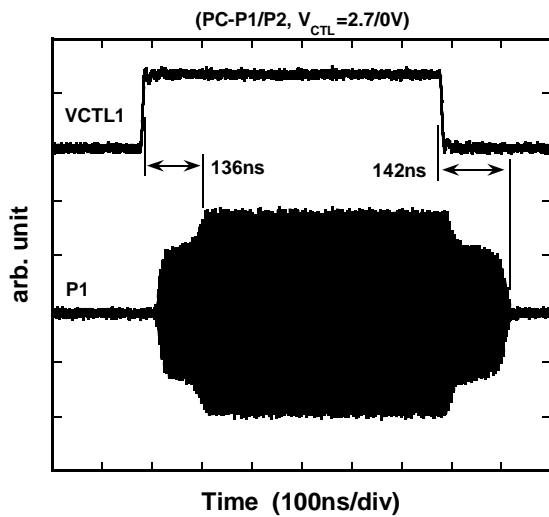

■ ELECTRICAL CHARACTERISTICS (With Application circuit, Loss of external circuit are excluded)

Insertion Loss vs Ambient Temperature

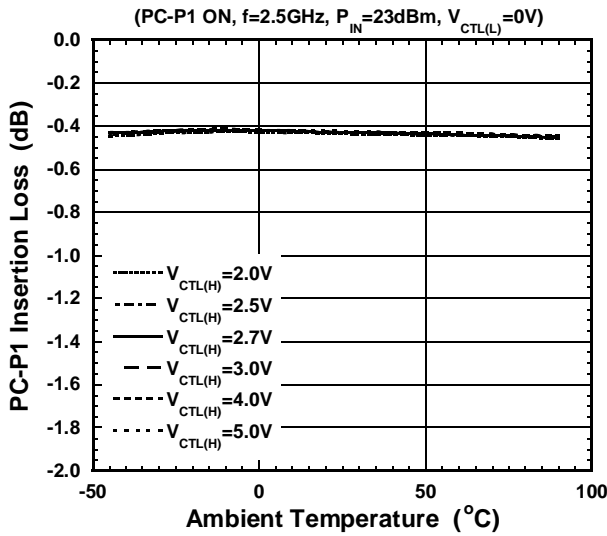

Isolation vs Ambient Temperature

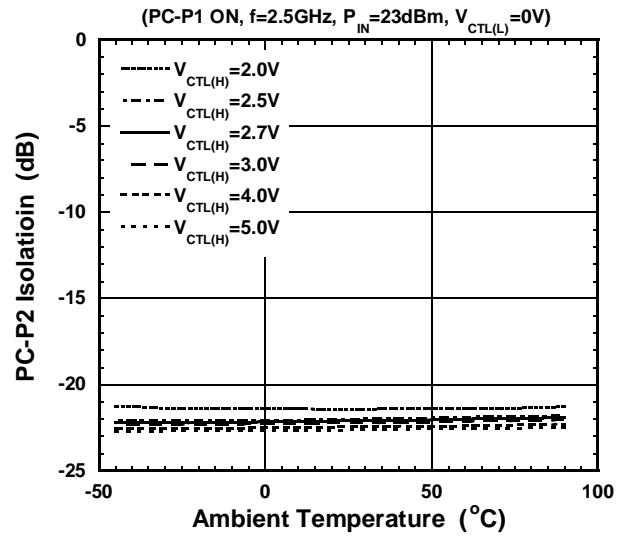

VSWR vs Ambient Temperature

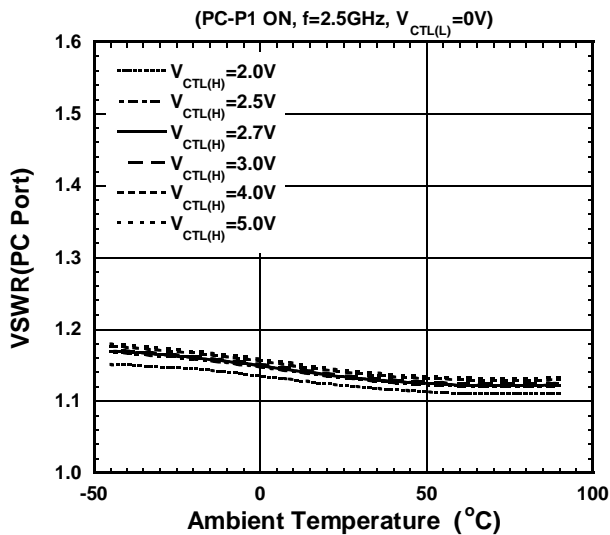

I_{CTL} vs Ambient Temperature

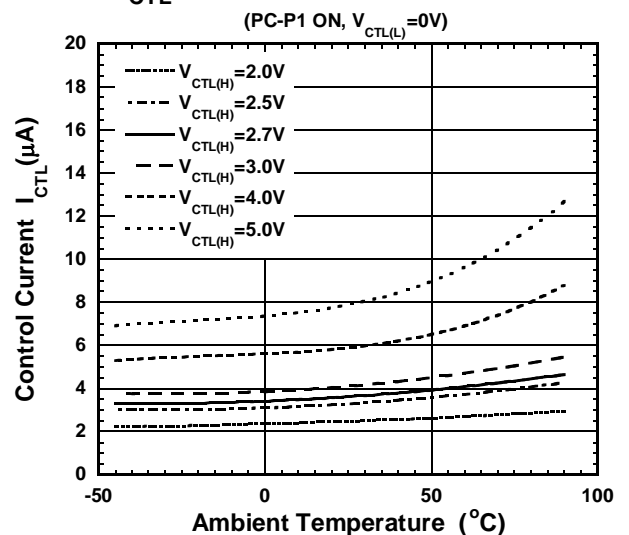

$P_{-0.2\text{dB}}$ vs Ambient Temperature

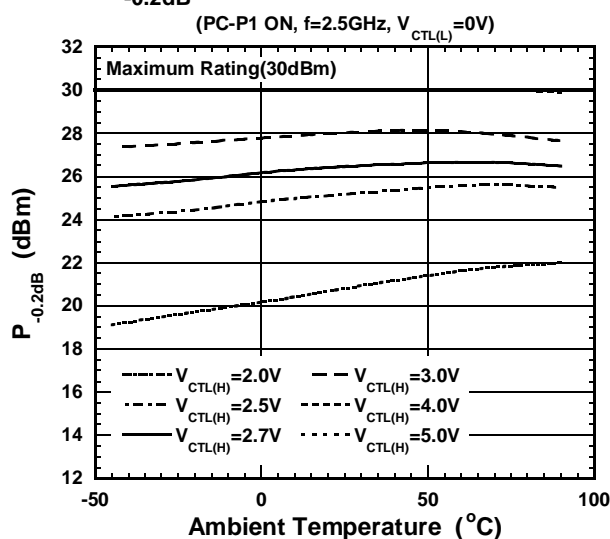

Switching Time vs Ambient Temperature

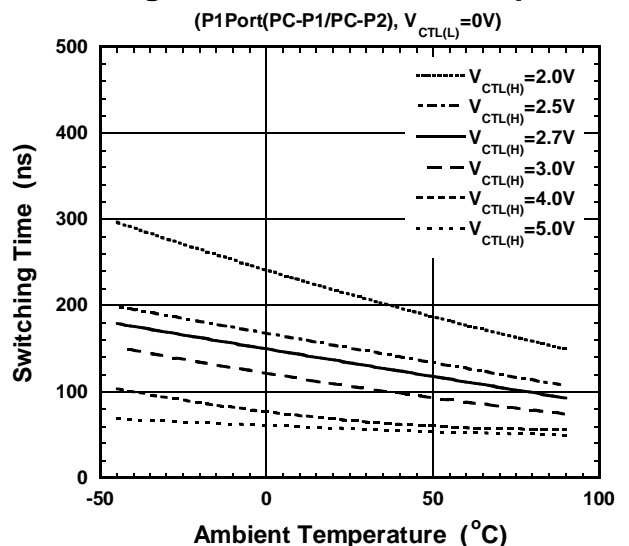

APPLICATION CIRCUIT

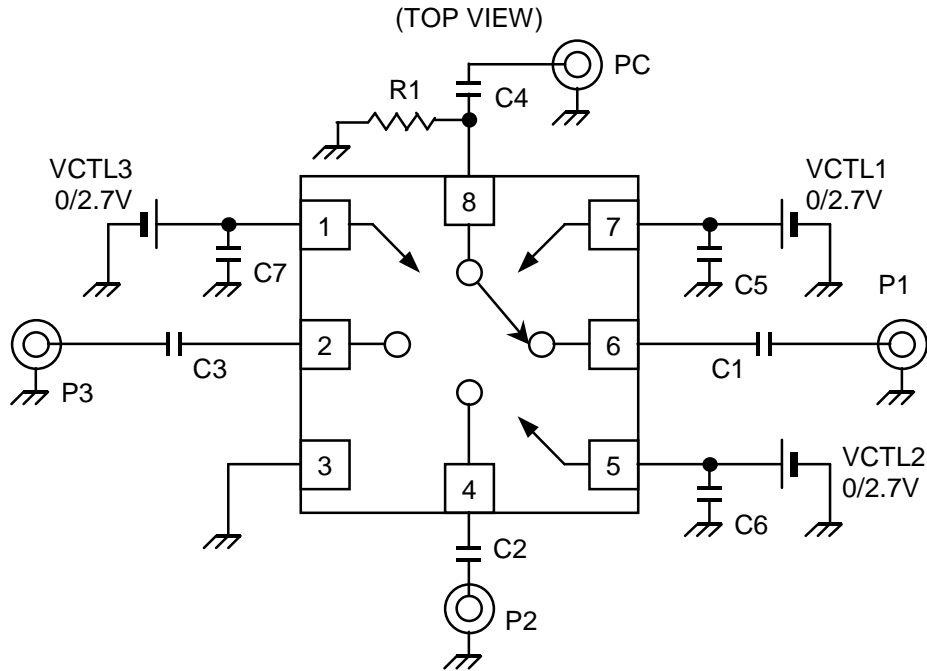

Parts List

Parts number	Value	Notes
C1~C4	56pF	GRM15 MURATA
C5~C7	10pF	
R1	560k ohm	-

TEST PCB LAYOUT

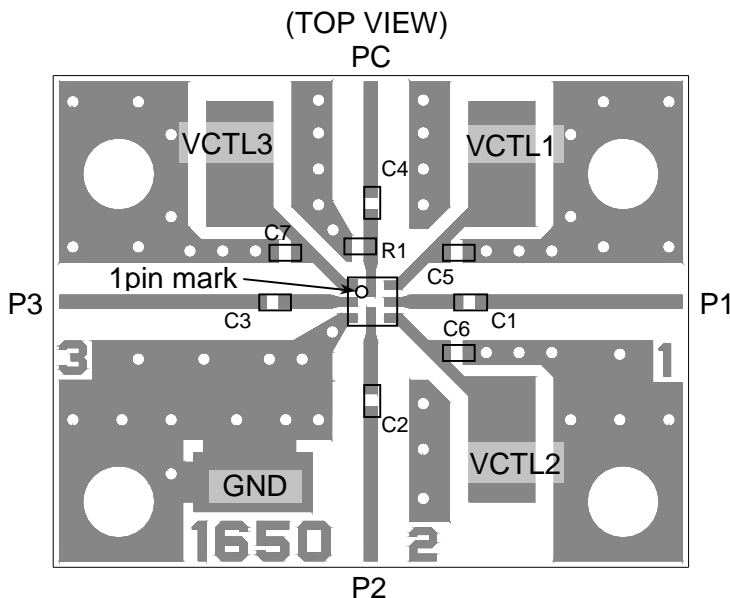

PCB SIZE=19.4x14.0mm

PCB: FR-4, t=0.2mm

CAPACITOR: size 1005

Stipline =0.4mm

Losses of PCB, Connector and capacitors

Freq.(GHz)	Loss (dB)
1.0	0.21
2.0	0.30
2.5	0.35

PRECAUTIONS

- [1] The DC blocking capacitors have to be placed at RF terminal of P1, P2, P3 and PC.
- [2] To reduce stripline influence on RF characteristics, please locate bypass capacitors (C5~C7) close to each terminal.
- [3] For good isolation, the GND terminal must be connected with the ground plane of substrate, and through-holes for GND should be placed near by the IC.

PACKAGE OUTLINE (USB8-B6)

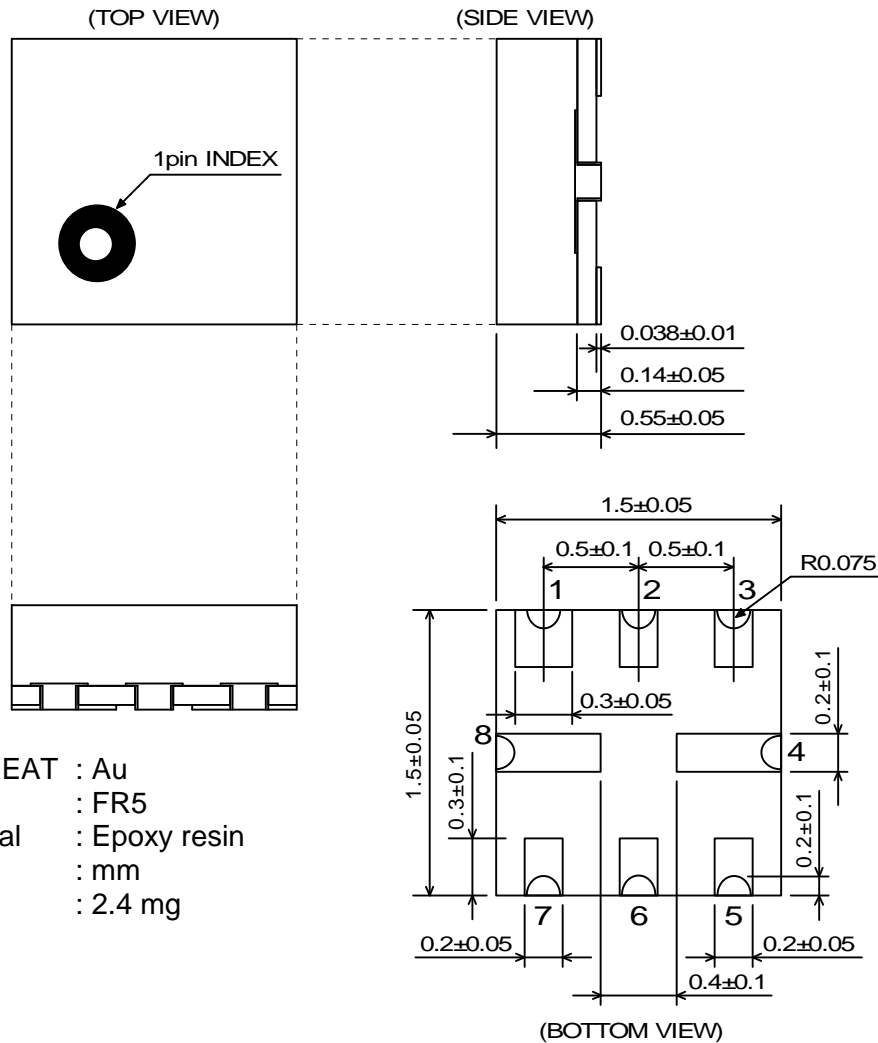

TERMINAL TREAT : Au
 Substrate : FR5
 Molding material : Epoxy resin
 UNIT : mm
 WEIGHT : 2.4 mg

Cautions on using this product

- This product contains Gallium-Arsenide (GaAs) which is a harmful material.
- Do NOT eat or put into mouth.
 - Do NOT dispose in fire or break up this product.
 - Do NOT chemically make gas or powder with this product.
 - To waste this product, please obey the relating law of your country.

[CAUTION]

The specifications on this databook are only given for information, without any guarantee as regards either mistakes or omissions. The application circuits in this databook are described only to show representative usages of the product and not intended for the guarantee or permission of any right including the industrial rights.

This product may be damaged with electric static discharge (ESD) or spike voltage. Please handle with care to avoid these damages.

1. The products and the product specifications described in this document are subject to change or discontinuation of production without notice for reasons such as improvement. Therefore, before deciding to use the products, please refer to our sales representatives for the latest information thereon.
2. The materials in this document may not be copied or otherwise reproduced in whole or in part without the prior written consent of us.
3. This product and any technical information relating thereto are subject to complementary export controls (so-called KNOW controls) under the Foreign Exchange and Foreign Trade Law, and related politics ministerial ordinance of the law. (Note that the complementary export controls are inapplicable to any application-specific products, except rockets and pilotless aircraft, that are insusceptible to design or program changes.) Accordingly, when exporting or carrying abroad this product, follow the Foreign Exchange and Foreign Trade Control Law and its related regulations with respect to the complementary export controls.
4. The technical information described in this document shows typical characteristics and example application circuits for the products. The release of such information is not to be construed as a warranty of or a grant of license under our or any third party's intellectual property rights or any other rights.
5. The products listed in this document are intended and designed for use as general electronic components in standard applications (office equipment, telecommunication equipment, measuring instruments, consumer electronic products, amusement equipment etc.). Those customers intending to use a product in an application requiring extreme quality and reliability, for example, in a highly specific application where the failure or misoperation of the product could result in human injury or death should first contact us.
 - Aerospace Equipment
 - Equipment Used in the Deep Sea
 - Power Generator Control Equipment (nuclear, steam, hydraulic, etc.)
 - Life Maintenance Medical Equipment
 - Fire Alarms / Intruder Detectors
 - Vehicle Control Equipment (automotive, airplane, railroad, ship, etc.)
 - Various Safety Devices
 - Traffic control system
 - Combustion equipment

In case your company desires to use this product for any applications other than general electronic equipment mentioned above, make sure to contact our company in advance. Note that the important requirements mentioned in this section are not applicable to cases where operation requirements such as application conditions are confirmed by our company in writing after consultation with your company.

6. We are making our continuous effort to improve the quality and reliability of our products, but semiconductor products are likely to fail with certain probability. In order to prevent any injury to persons or damages to property resulting from such failure, customers should be careful enough to incorporate safety measures in their design, such as redundancy feature, fire containment feature and fail-safe feature. We do not assume any liability or responsibility for any loss or damage arising from misuse or inappropriate use of the products.
7. The products have been designed and tested to function within controlled environmental conditions. Do not use products under conditions that deviate from methods or applications specified in this datasheet. Failure to employ the products in the proper applications can lead to deterioration, destruction or failure of the products. We shall not be responsible for any bodily injury, fires or accident, property damage or any consequential damages resulting from misuse or misapplication of the products.
8. **Quality Warranty**
 - 8-1. **Quality Warranty Period**

In the case of a product purchased through an authorized distributor or directly from us, the warranty period for this product shall be one (1) year after delivery to your company. For defective products that occurred during this period, we will take the quality warranty measures described in section 8-2. However, if there is an agreement on the warranty period in the basic transaction agreement, quality assurance agreement, delivery specifications, etc., it shall be followed.
 - 8-2. **Quality Warranty Remedies**

When it has been proved defective due to manufacturing factors as a result of defect analysis by us, we will either deliver a substitute for the defective product or refund the purchase price of the defective product.

Note that such delivery or refund is sole and exclusive remedies to your company for the defective product.
 - 8-3. **Remedies after Quality Warranty Period**

With respect to any defect of this product found after the quality warranty period, the defect will be analyzed by us. On the basis of the defect analysis results, the scope and amounts of damage shall be determined by mutual agreement of both parties. Then we will deal with upper limit in Section 8-2. This provision is not intended to limit any legal rights of your company.
9. Anti-radiation design is not implemented in the products described in this document.
10. The X-ray exposure can influence functions and characteristics of the products. Confirm the product functions and characteristics in the evaluation stage.
11. WLCSP products should be used in light shielded environments. The light exposure can influence functions and characteristics of the products under operation or storage.
12. Warning for handling Gallium and Arsenic (GaAs) products (Applying to GaAs MMIC, Photo Reflector). These products use Gallium (Ga) and Arsenic (As) which are specified as poisonous chemicals by law. For the prevention of a hazard, do not burn, destroy, or process chemically to make them as gas or power. When the product is disposed of, please follow the related regulation and do not mix this with general industrial waste or household waste.
13. Please contact our sales representatives should you have any questions or comments concerning the products or the technical information.



Nisshinbo Micro Devices Inc.

Official website

<https://www.nisshinbo-microdevices.co.jp/en/>

Purchase information

<https://www.nisshinbo-microdevices.co.jp/en/buy/>