

450MHz Band LNA GaAs MMIC

■ GENERAL DESCRIPTION

NJG1128HB6 is a LNA IC designed for 450MHz band CDMA cellular phone. This IC has the function which bypasses LNA, and high gain mode or low gain mode can be chosen.

High IIP3 and a low noise are achieved at the High gain mode. And low current consumption can be achieved at the low gain mode because LNA enters the state of the standby.

A small and thin package of USB8 is adopted.

■ PACKAGE OUTLINE

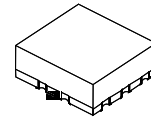

NJG1128HB6

■ FEATURES

- Low voltage operation +2.8V typ.
- Low control voltage operation +1.85V typ.

- [LNA High Gain Mode]
- High Input IP3 +11.0dBm typ. @ f=460-470MHz
- Low noise figure 1.4dB typ. @ f=460-470MHz

- [LNA Low Gain Mode]
- Low current consumption 15uA typ.
- High Input IP3 +21.0dBm typ. @ f=460-470MHz

- Small & thin package USB8-B6 (Package size: 1.5mm x1.5mm x 0.55mm typ.)

■ PIN CONFIGURATION

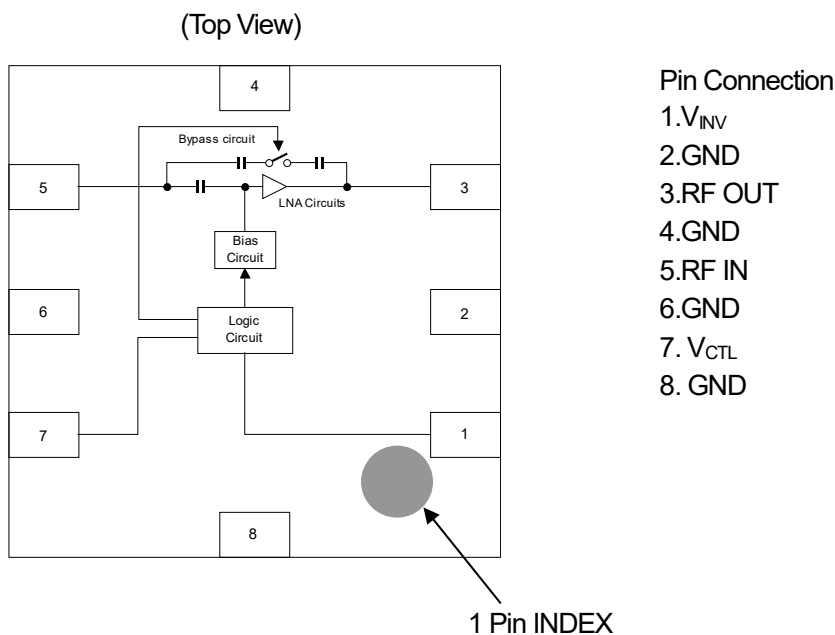

Note: Specifications and description listed in this catalog are subject to change without prior notice.

NJG1128HB6

■ ABSOLUTE MAXIMUM RATINGS

($T_a=+25^{\circ}\text{C}$, $Z_s=Z_l=50\Omega$)

PARAMETERS	SYMBOL	CONDITIONS	RATINGS	UNITS
Supply voltage	V_{DD}		5.0	V
Inverter supply voltage	V_{INV}		5.0	V
Control voltage	V_{CTL}		5.0	V
Input power	P_{in}		+15	dBm
Power dissipation	P_D	on PCB board, at $T_{jmax}=150^{\circ}\text{C}$	160	mW
Operating temperature	T_{opr}		-40~+85	$^{\circ}\text{C}$
Storage temperature	T_{stg}		-55~+150	$^{\circ}\text{C}$

■ ELECTRICAL CHARACTERISTICS 1 (DC CHARACTERISTICS)

(General Conditions: $V_{DD}=V_{INV}=2.8\text{V}$, $T_a=+25^{\circ}\text{C}$, $Z_s=Z_l=50\Omega$)

PARAMETERS	SYMBOL	CONDITIONS	MIN	TYP	MAX	UNITS
Operating voltage	V_{DD}		2.65	2.80	2.95	V
Inverter supply voltage	V_{INV}		2.65	2.80	2.95	V
Control voltage (High)	$V_{CTL(H)}$		1.80	1.85	$V_{DD}+0.3$	V
Control voltage (Low)	$V_{CTL(L)}$		-0.3	0	0.3	V
Operating current1 (LNA High Gain Mode)	I_{DD1}	RF OFF, $V_{CTL}=1.85\text{V}$	-	10.0	16.0	mA
Operating current2 (LNA Low Gain Mode)	I_{DD2}	RFOFF, $V_{CTL}=0\text{V}$	-	1	5	μA
Inverter current1 (LNA High Gain Mode)	I_{INV1}	RF OFF, $V_{CTL}=1.85\text{V}$	-	150	240	μA
Inverter current2 (LNA Low Gain Mode)	I_{INV2}	RF OFF, $V_{CTL}=0\text{V}$	-	15	40	μA
Control current	I_{CTL}	RF OFF, $V_{CTL}=1.85\text{V}$	-	5	15	μA

■ **ELECTRICAL CHARACTERISTICS 2 (LNA High Gain Mode)**

(General Conditions: $V_{DD}=V_{INV}=2.8V$, $V_{CTL}=1.85V$, $f_{RF}=460-470MHz$, $T_a=+25^{\circ}C$, $Z_s=Z_l=50\Omega$)

PARAMETERS	SYMBOL	CONDITIONS	MIN	TYP	MAX	UNITS
Small signal gain1	Gain1		13.5	15.0	17.0	dB
Noise figure1	NF1	Exclude PCB & connector losses	-	1.4	1.8	dB
1dB gain compression output power1	P-1dB_1		+4.0	+9.0	-	dBm
3rd order Input Intercept Point1	IIP3_1	$f1=f_{RF}$, $f2=f_{RF}+100kHz$, $P_{in}=-25dBm$	+8.0	+11.0	-	dBm
RF IN VSWR1	VSWR _{i_1}		-	1.5	2.0	
RF OUT VSWR1	VSWR _{o_1}		-	2.3	2.7	

■ **ELECTRICAL CHARACTERISTICS 3 (LNA Low Gain Mode)**

(General Conditions: $V_{DD}=V_{INV}=2.8V$, $V_{CTL}=0V$, $f_{RF}=460-470MHz$, $T_a=+25^{\circ}C$, $Z_s=Z_l=50\Omega$)

PARAMETERS	SYMBOL	CONDITIONS	MIN	TYP	MAX	UNITS
Small signal gain2	Gain2		-5.0	-3.0	0	dB
Noise figure2	NF2	Exclude PCB & connector losses	-	3.0	4.5	dB
1dB gain compression output power2	P-1dB_2		+1.0	+8.0	-	dBm
3rd order Input Intercept Point2	IIP3_2	$f1=f_{RF}$, $f2=f_{RF}+100kHz$, $P_{in}=-12dBm$	+15.0	+21.0	-	dBm
RF IN VSWR2	VSWR _{i_2}		-	2.3	2.7	
RF OUT VSWR2	VSWR _{o_2}		-	1.5	2.0	

NJG1128HB6

■ TERMINAL INFORMATION

No.	SYMBOL	DESCRIPTION
1	VINV	Supply voltage terminal for internal logic circuit (inverter).
2	GND	Ground terminal.
3	RFOUT	RF signal comes out from this terminal, and goes through an external matching circuit connected to this. Inductor L3 as shown in the application circuit is a part of an external matching circuit, and also provide DC power to LNA. Capacitor C3 as shown in the application circuit is a bypass capacitor.
4	GND	Ground terminal.
5	RFIN	RF input terminal. The RF signal is input through external matching circuit connected to this terminal. A DC blocking capacitor is not required.
6	GND	Ground terminal.
7	VCTL	Control port. A logic control signal is required to select High or Low gain mode of LNA. This terminal is set to more than +1.8V of logical high level for High gain mode of LNA, and set to -0.3~+0.3V of logical low level for Low gain mode.
8	GND	Ground terminal.

CAUTION

- 1) Ground terminal (No.2, 4, 6, 8) should be connected to the ground plane as close as possible for excellent RF performance, because distance to GND makes parasitic inductance.

■ TRUTH TABLE

"H"= $V_{CTL}(H)$, "L"= $V_{CTL}(L)$

V_{CTL}	Gain Mode	LNA
L	Low	bypass
H	High	pass

■ ELECTRICAL CHARACTERISTICS (LNA High Gain Mode)

(General Conditions: $T_a=+25^\circ\text{C}$, $V_{DD}=V_{INV}=2.8\text{V}$, $V_{CTL}=1.85\text{V}$, $Z_s=Z_l=50\Omega$)

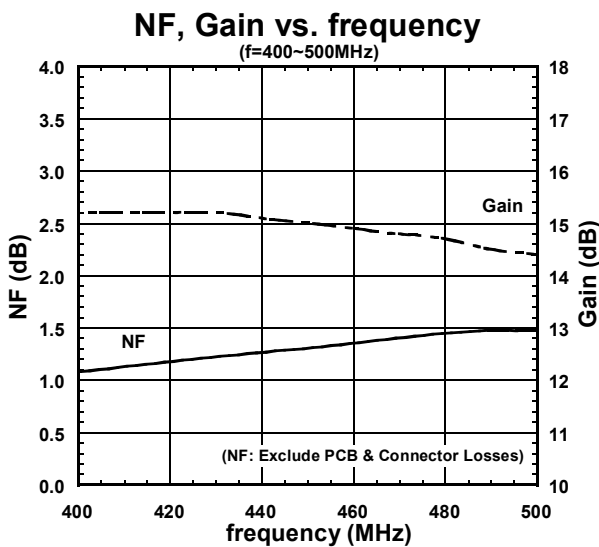
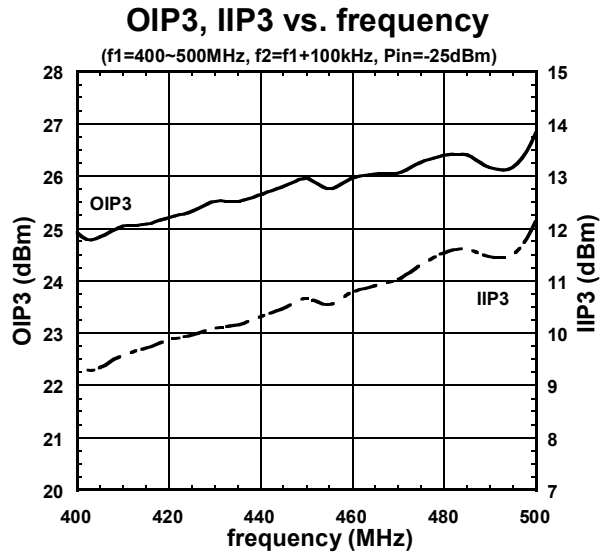
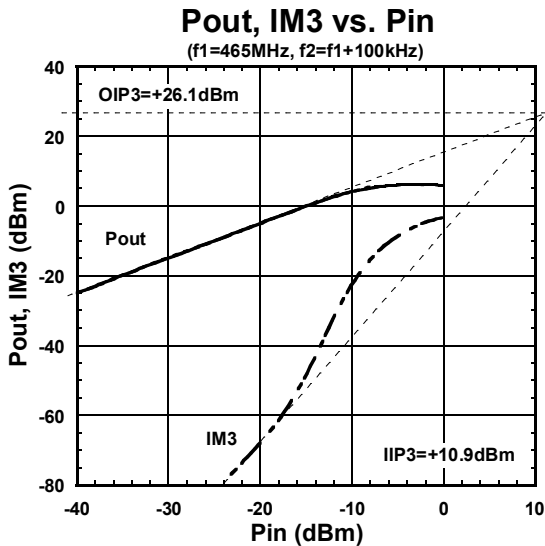
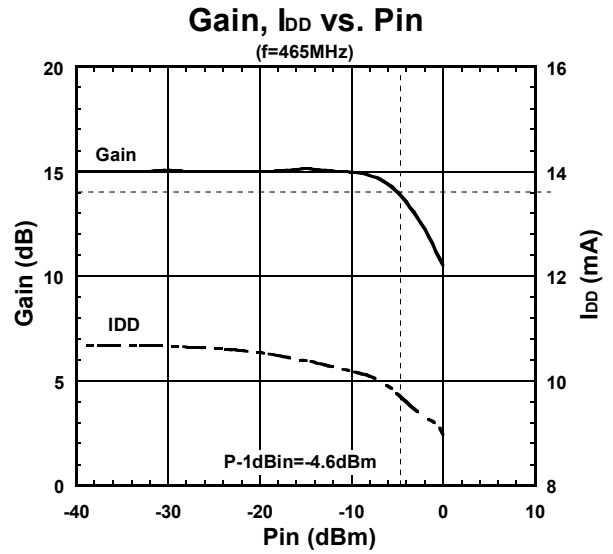
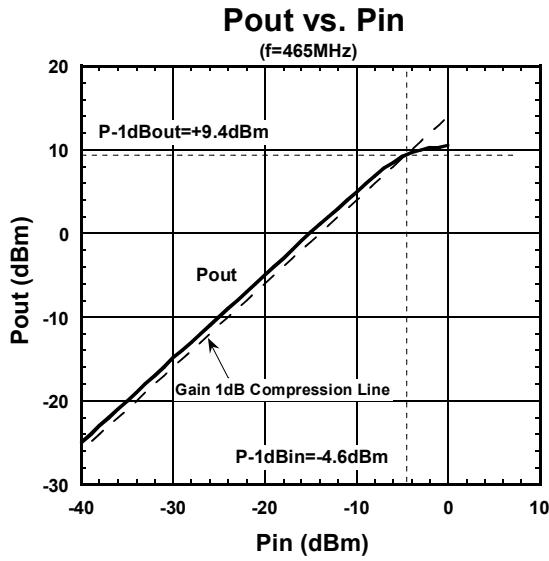

NJG1128HB6

ELECTRICAL CHARACTERISTICS (LNA High Gain Mode)

(General Conditions: $T_a=+25^{\circ}\text{C}$, $V_{DD}=V_{INV}=2.8\text{V}$, $V_{CTL}=1.85\text{V}$, $Z_s=Z_l=50\Omega$)

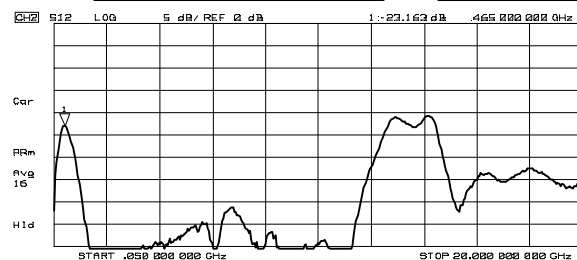
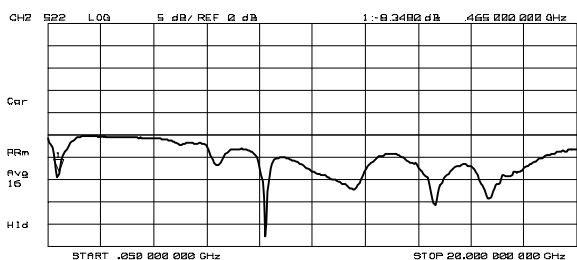
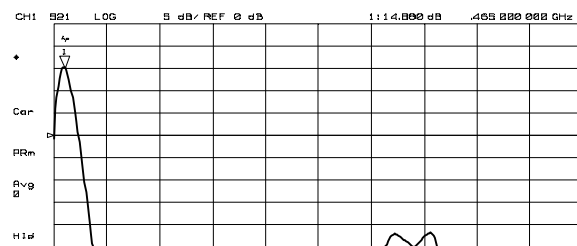
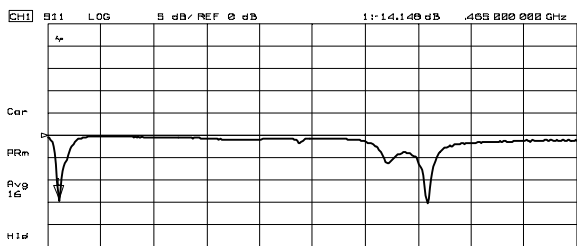
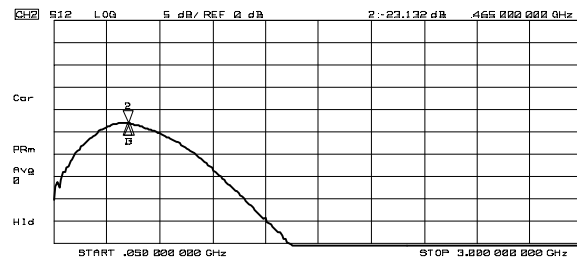
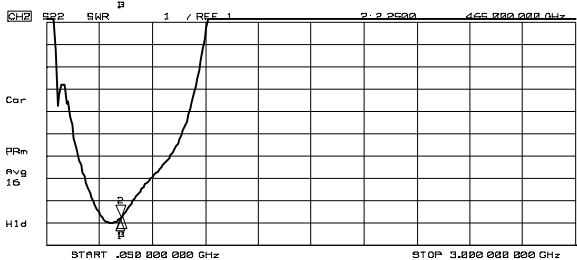
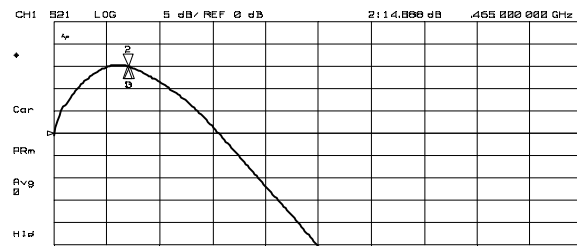
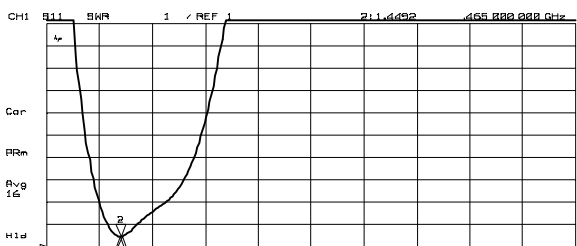
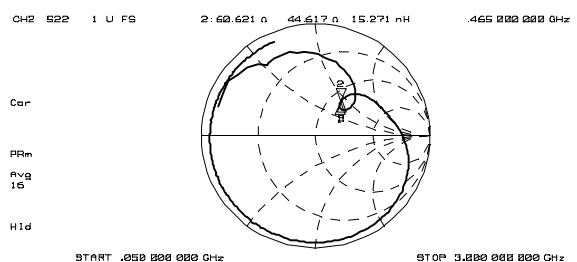
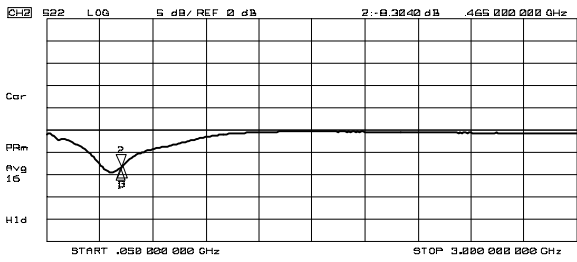
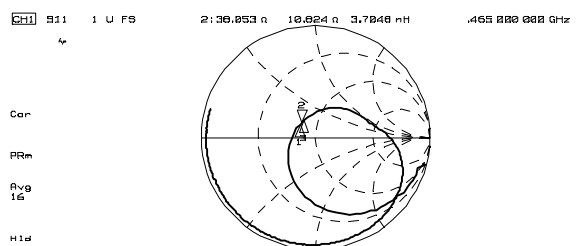
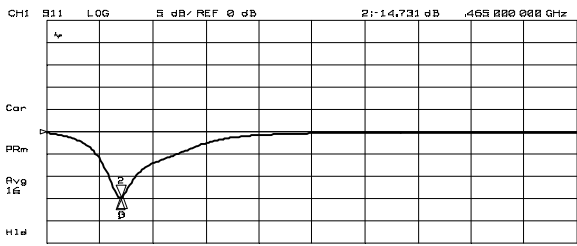

■ ELECTRICAL CHARACTERISTICS (LNA High Gain Mode)

(General Conditions: $T_a=+25^\circ\text{C}$, $V_{DD}=V_{INV}=2.8\text{V}$, $V_{CTL}=1.85\text{V}$, $Z_s=Z_l=50\Omega$)

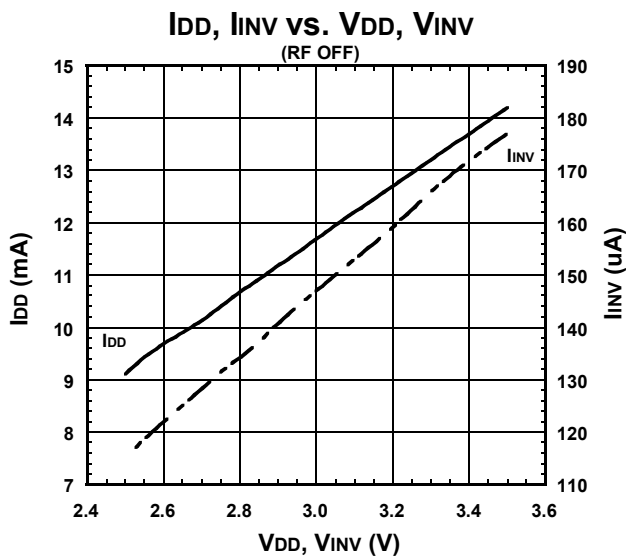
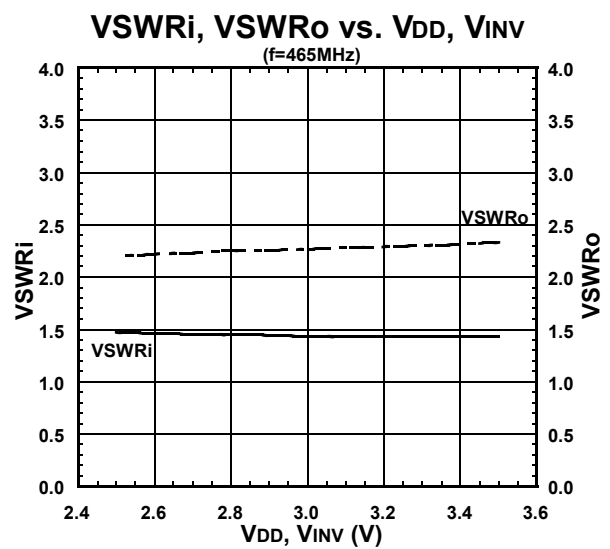
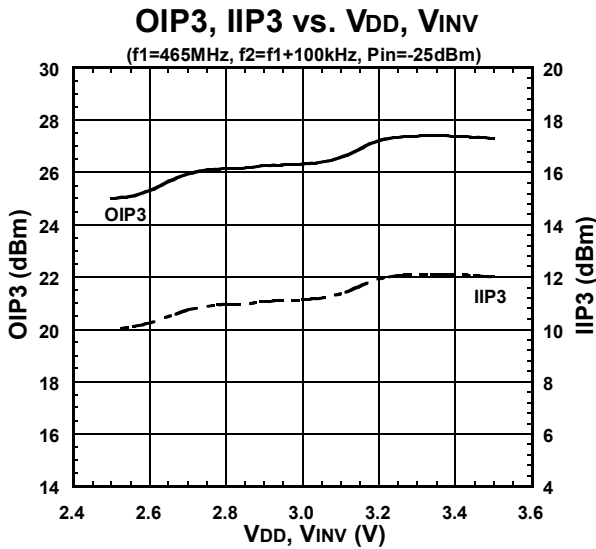
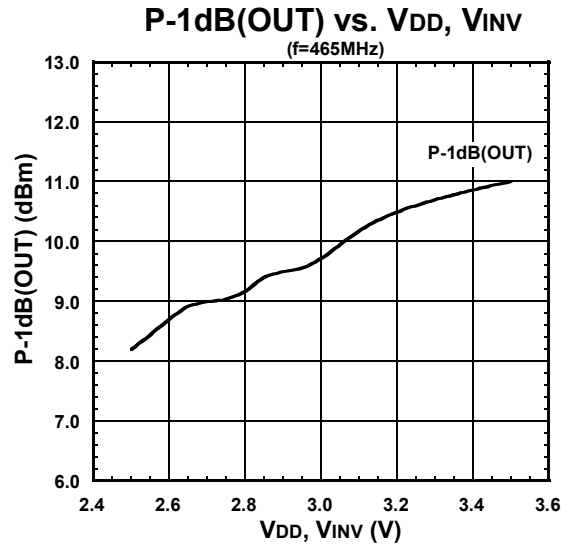
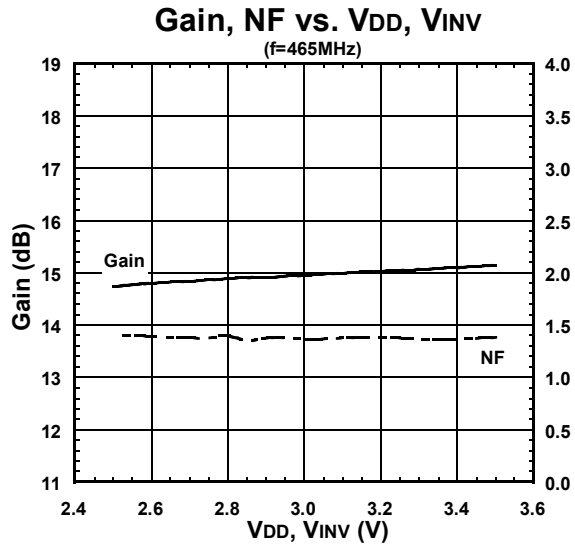

NJG1128HB6

■ ELECTRICAL CHARACTERISTICS (LNA High Gain Mode)

(General Conditions: $T_a=+25^\circ\text{C}$, $V_{DD}=V_{INV}=2.8\text{V}$, $V_{CTL}=1.85\text{V}$, $Z_s=Z_l=50\Omega$)

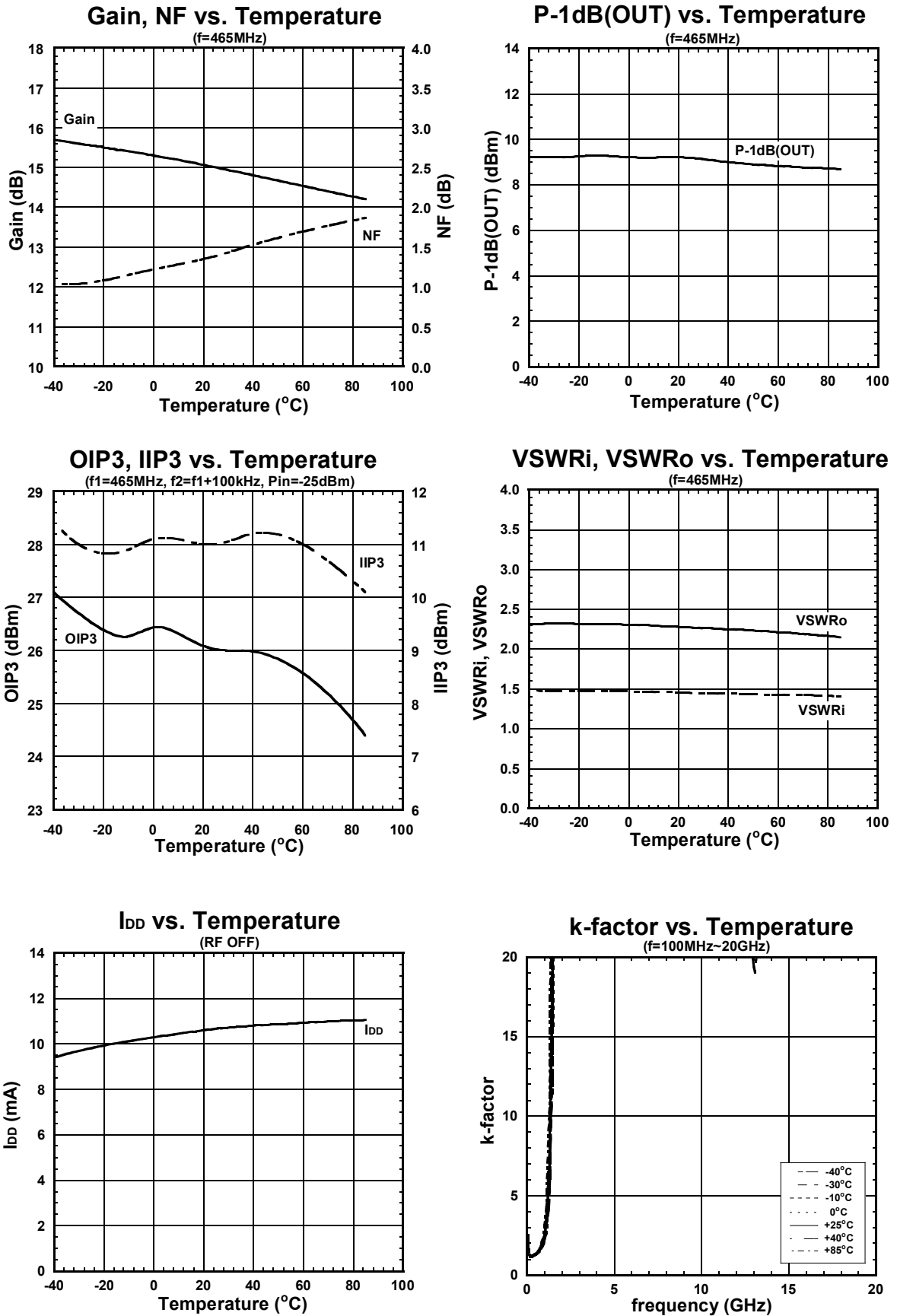

■ ELECTRICAL CHARACTERISTICS (LNA Low Gain Mode)

(General Conditions: $T_a=+25^{\circ}\text{C}$, $V_{DD}=V_{INV}=2.8\text{V}$, $V_{CTL}=0\text{V}$, $Z_s=Z_l=50\Omega$)

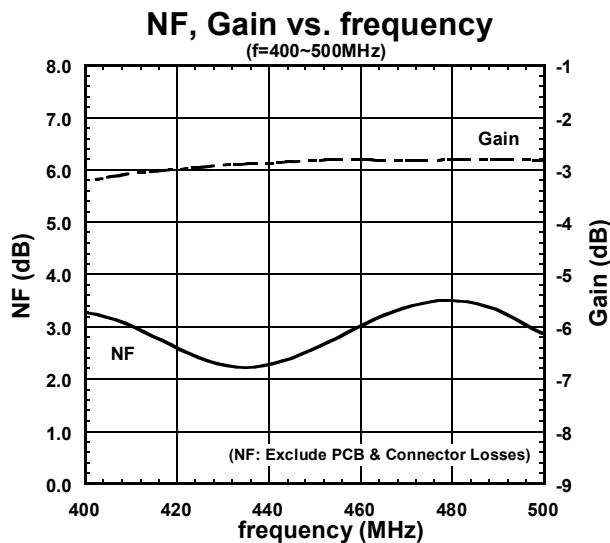
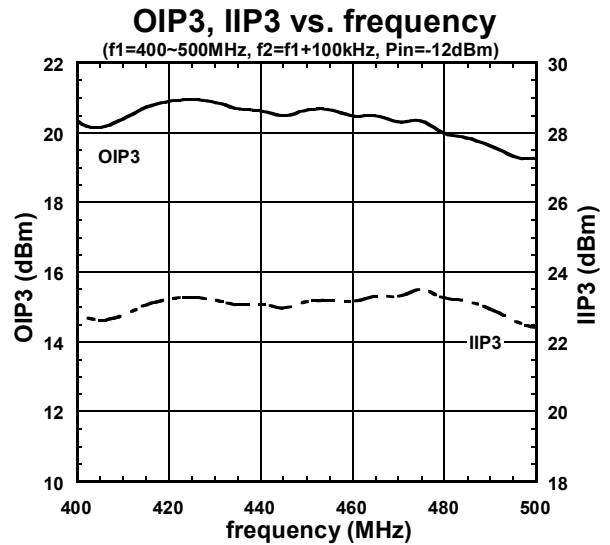
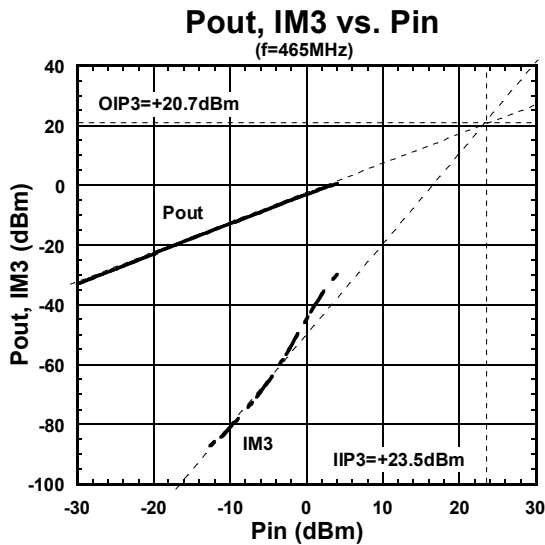
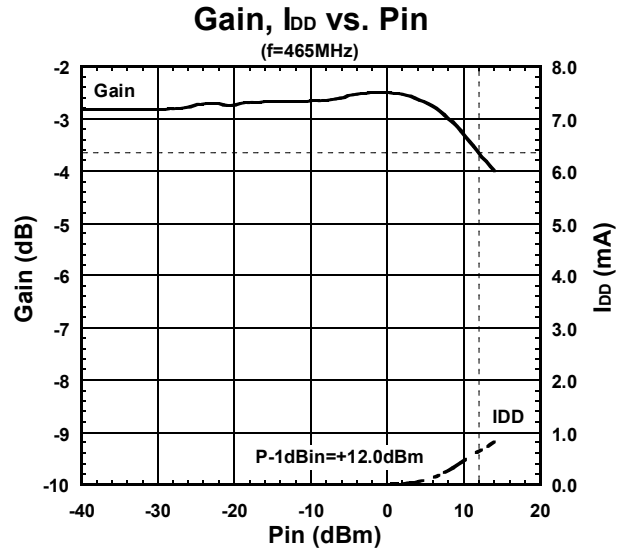
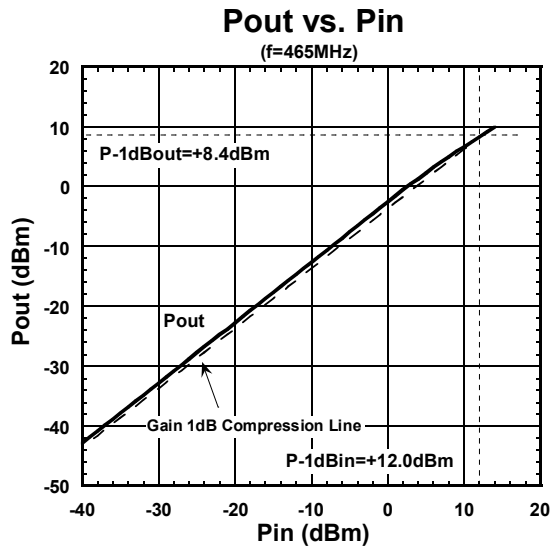

NJG1128HB6

■ ELECTRICAL CHARACTERISTICS (LNA Low Gain Mode)

(General Conditions: $T_a=+25^{\circ}\text{C}$, $V_{DD}=V_{INV}=2.8\text{V}$, $V_{CTL}=0\text{V}$, $Z_s=Z_l=50\Omega$)

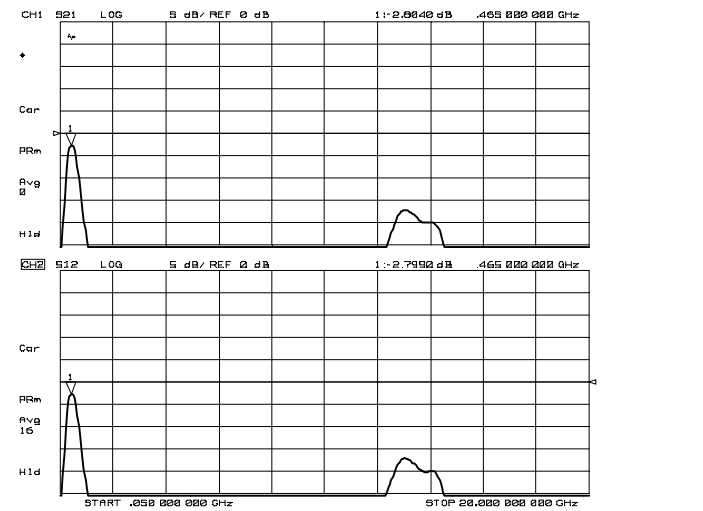
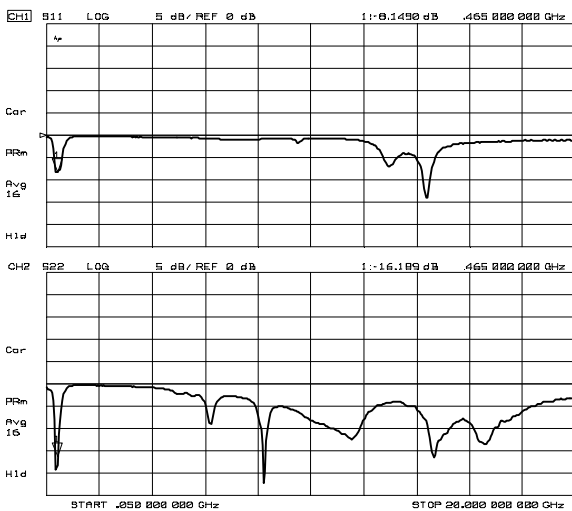
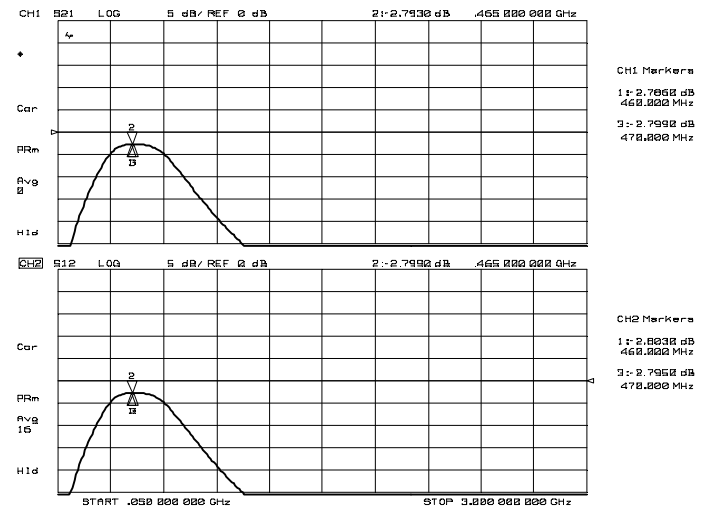
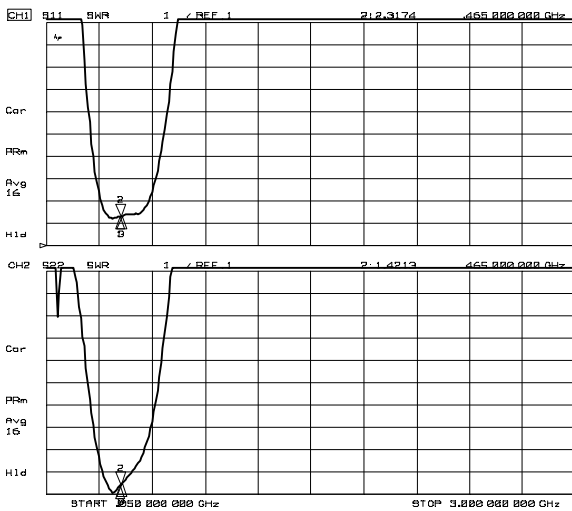
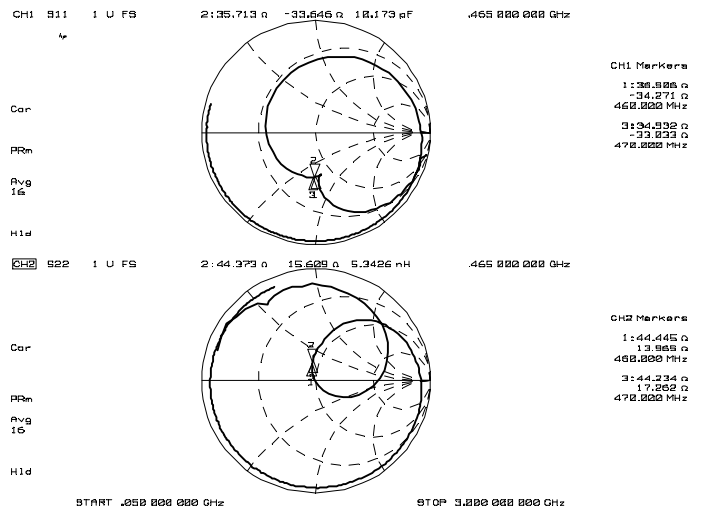
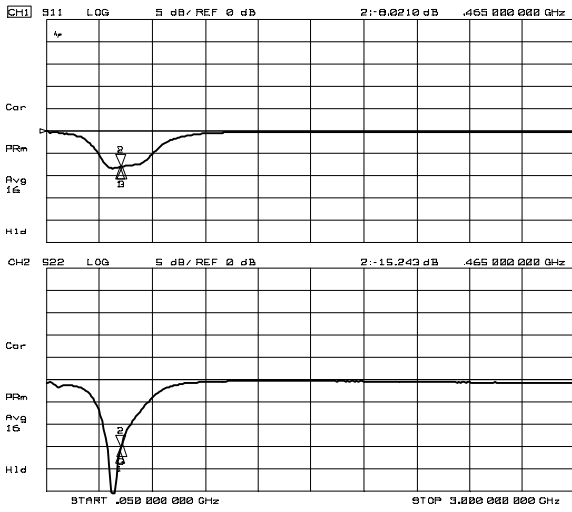

■ ELECTRICAL CHARACTERISTICS (LNA Low Gain Mode)

(General Conditions: $T_a=+25^\circ\text{C}$, $V_{DD}=V_{INV}=2.8\text{V}$, $V_{CTL}=0\text{V}$, $Z_s=Z_l=50\Omega$)

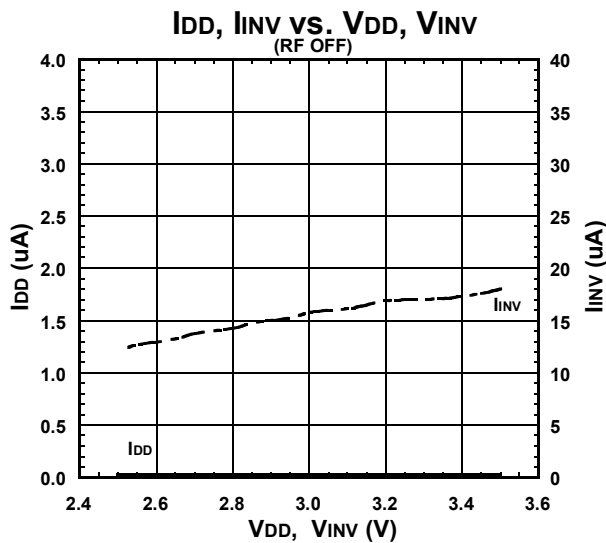
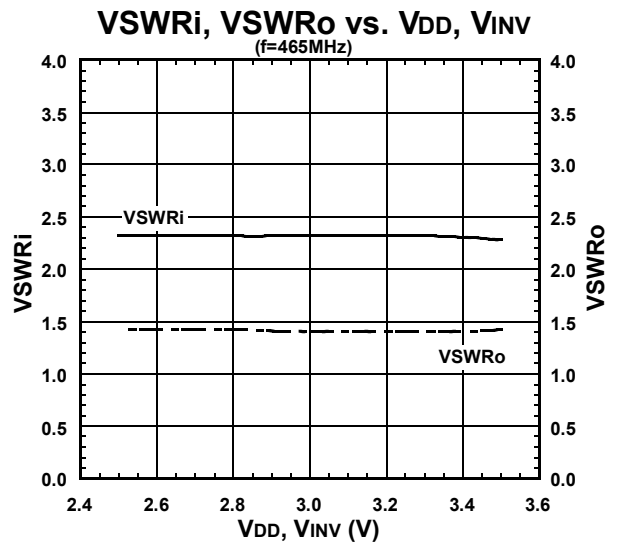
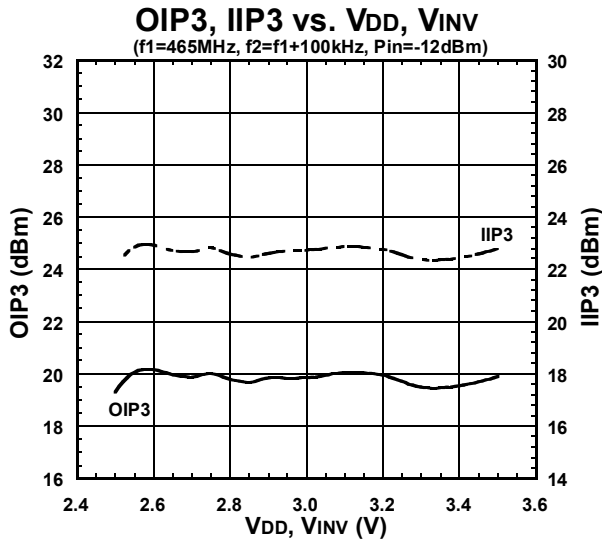
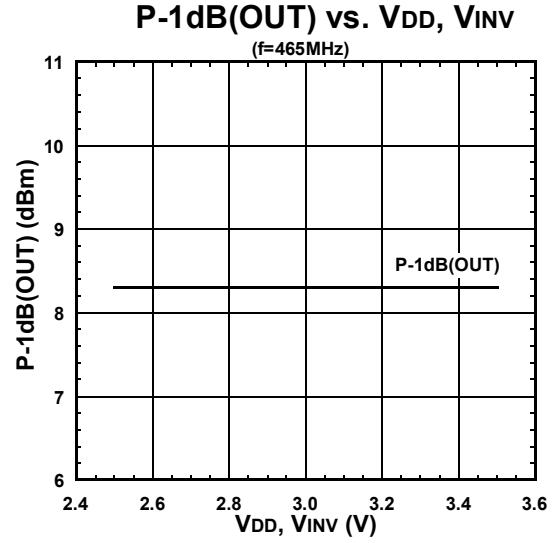
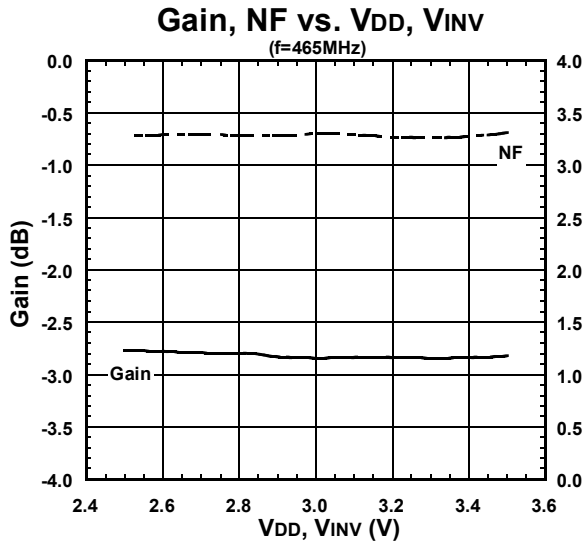

NJG1128HB6

■ ELECTRICAL CHARACTERISTICS (LNA Low Gain Mode)

(General Conditions: $T_a=+25^\circ\text{C}$, $V_{DD}=V_{INV}=2.8\text{V}$, $V_{CTL}=0\text{V}$, $Z_s=Z_l=50\Omega$)

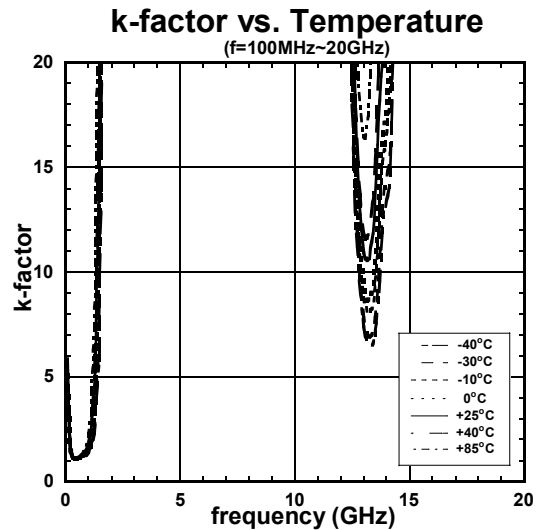
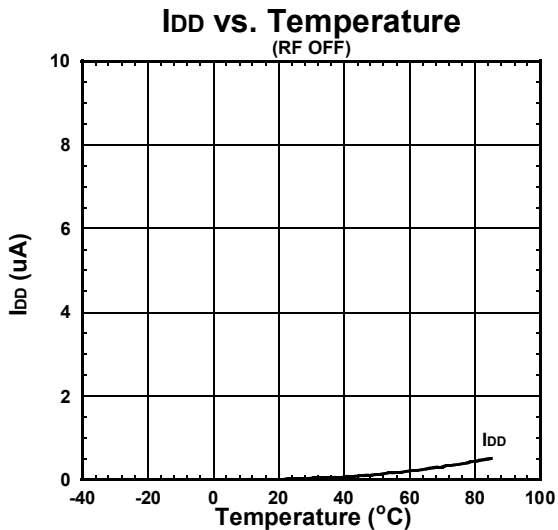
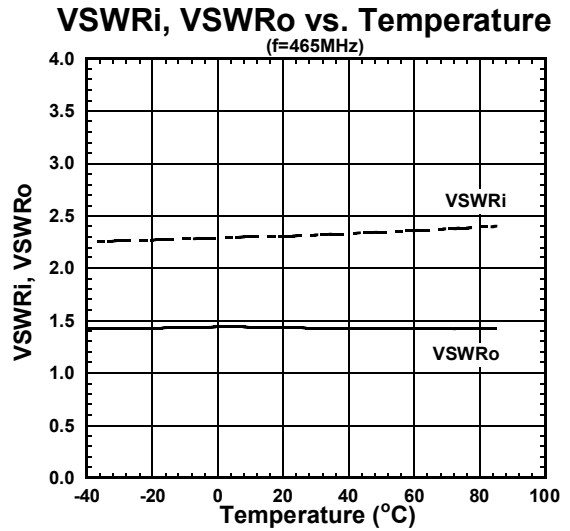
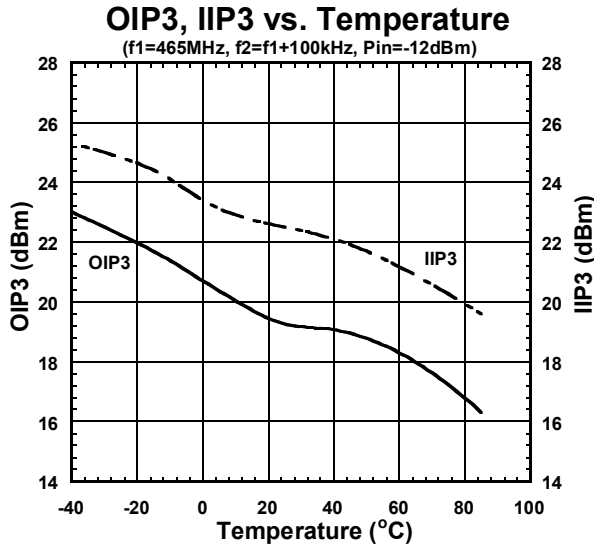
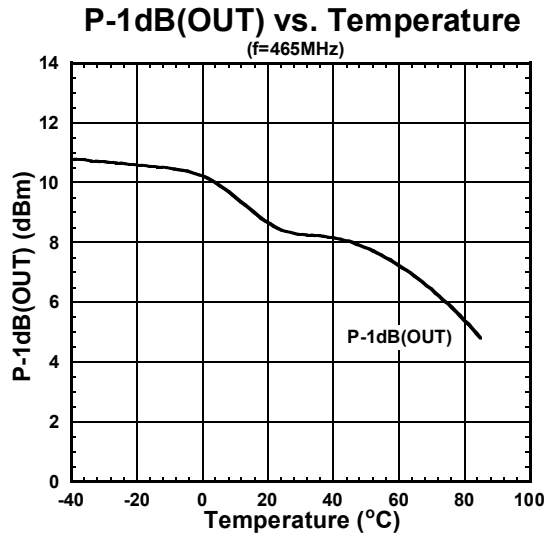
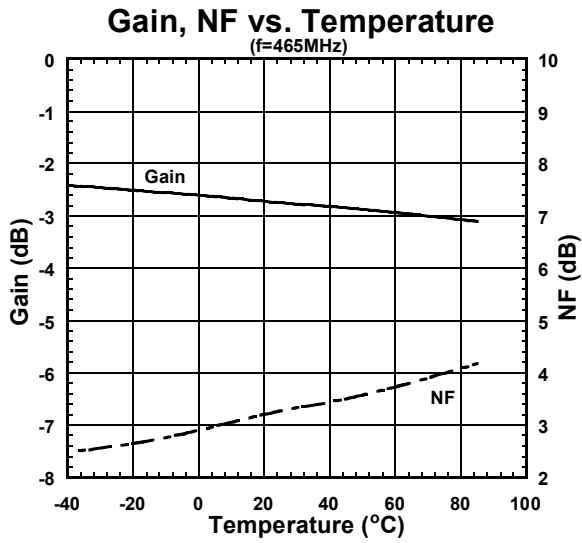

APPLICATION CIRCUIT

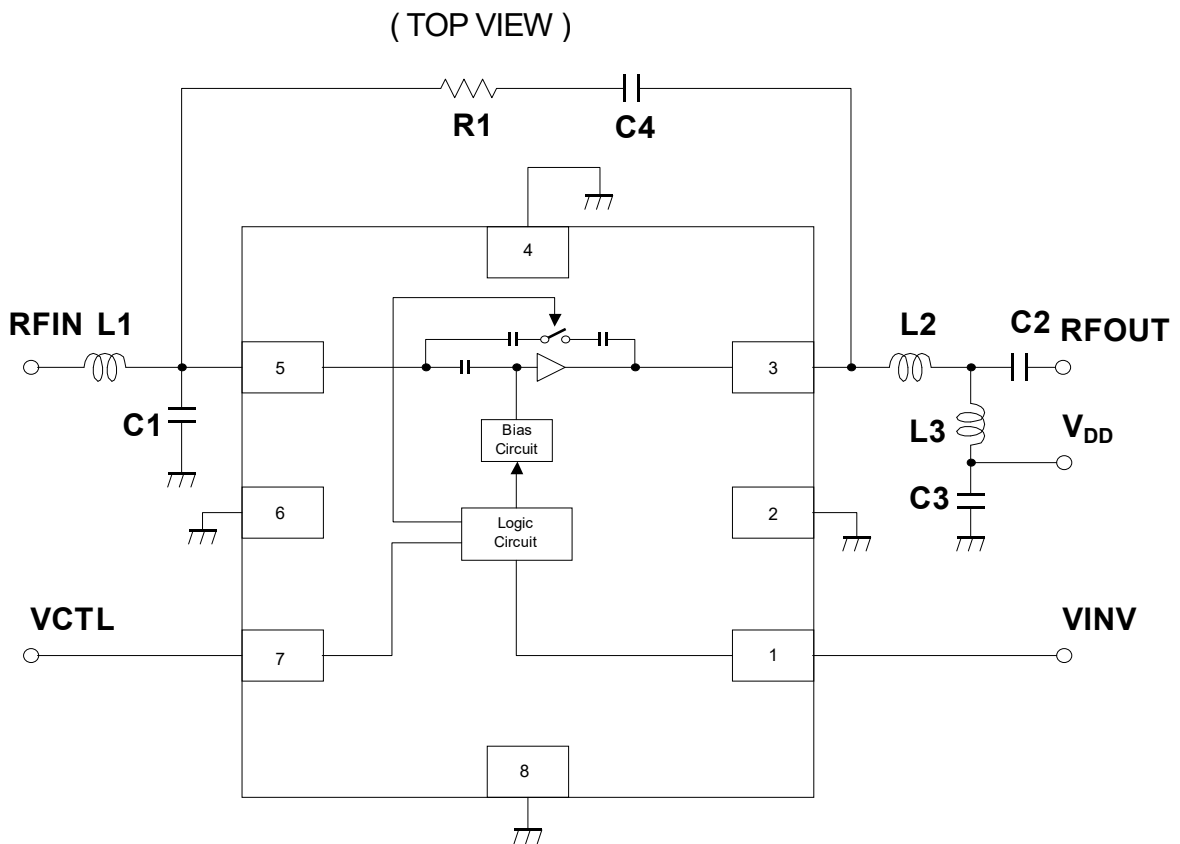

Parts List

PART ID	CONSTANTS	COMMENT
L1	27nH	MURATA (LQW15A)
L2	33nH	TAIYO-YUDEN (HK1005)
L3	33nH	TAIYO-YUDEN (HK1005)
C1	0.75pF	MURATA (GRM15)
C2	1000pF	MURATA (GRM15)
C3	1000pF	MURATA (GRM15)
C4	2pF	MURATA (GRM15)
R1	2.7k Ω	1005size

NJG1128HB6

■ TEST PCB LAYOUT

(Top View)

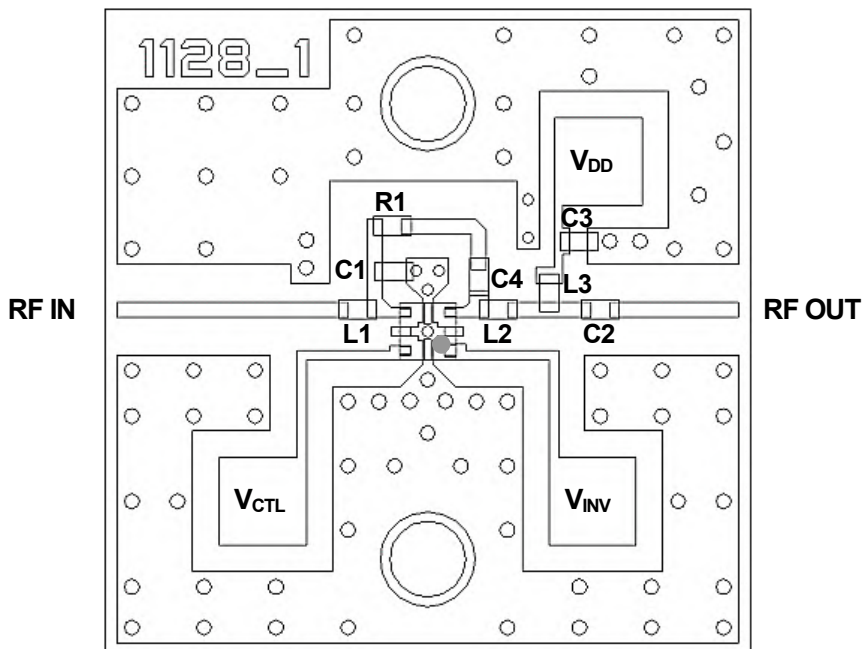

PCB(FR-4),t=0.2mm

MICROSTRIP LINE WIDTH=0.4mm($Z_0=50\Omega$)

PCB SIZE : 17.0 X 17.0mm

PRECAUTIONS

- [1] C1 and L1 form the input matching circuit. They should be placed close to RFIN terminal (5th pin).
- [2] L2 and L3 form the output matching circuit. They should be placed close to RFOUT terminal (3rd pin).
- [3] R1 and C4 form the negative feedback circuit. The pattern between RFOUT terminal (3rd pin) and RFIN terminal (5th pin) should be designed as short as possible for good performance.
- [4] C2 is a DC-blocking capacitor.
- [5] C3 is a bypass capacitor, it should be placed close to L3.
- [6] Ground terminals(2nd, 4th, 6th and 8th pin) should be connected to ground plane as close as possible for good performance.

■ PACKAGE OUTLINE (USB8-B6)

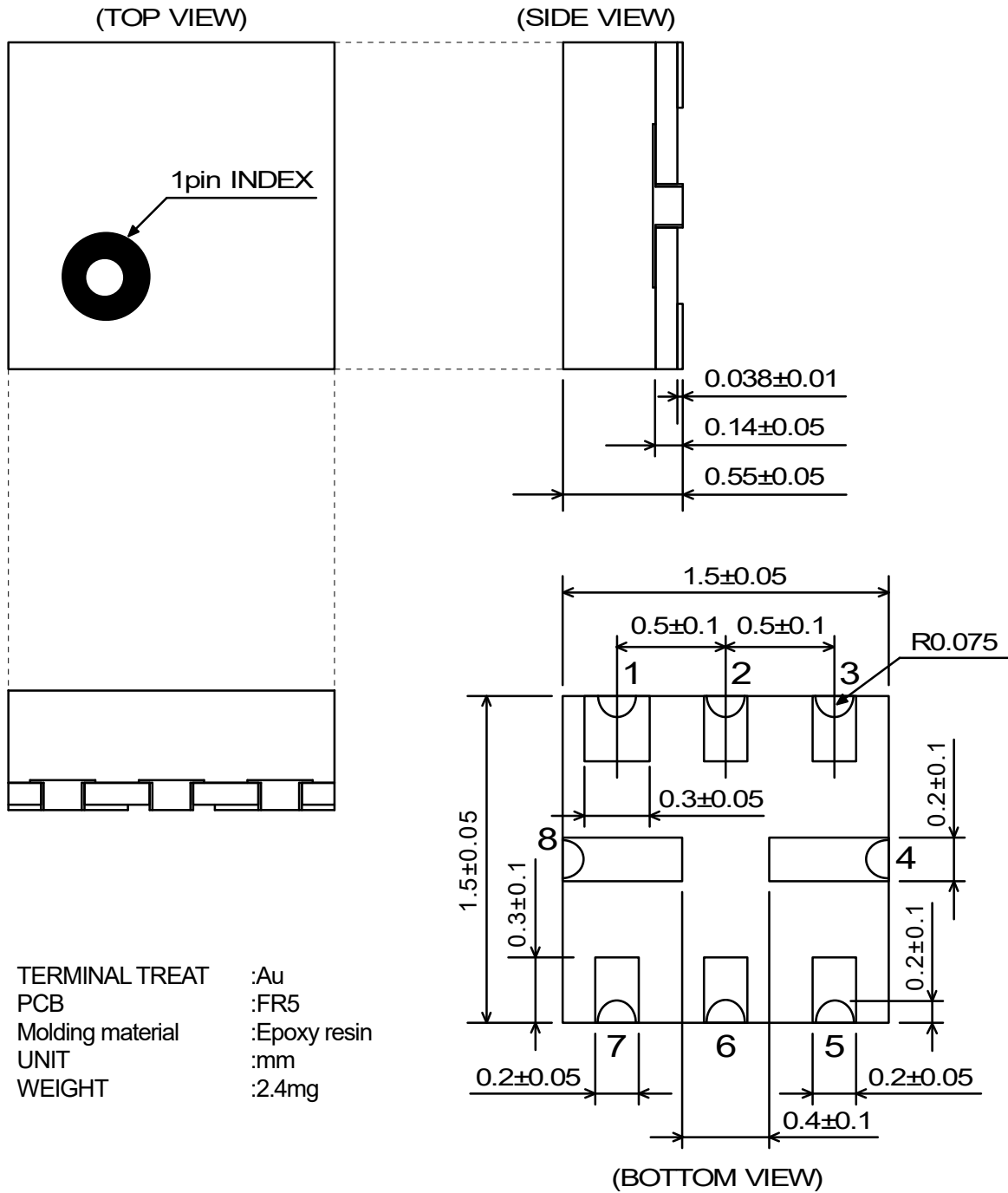

Cautions on using this product

- This product contains Gallium-Arsenide (GaAs) which is a harmful material.
- Do NOT eat or put into mouth.
 - Do NOT dispose in fire or break up this product.
 - Do NOT chemically make gas or powder with this product.
 - To waste this product, please obey the relating law of your country.

[CAUTION]

The specifications on this databook are only given for information, without any guarantee as regards either mistakes or omissions. The application circuits in this databook are described only to show representative usages of the product and not intended for the guarantee or permission of any right including the industrial rights.

This product may be damaged with electric static discharge (ESD) or spike voltage. Please handle with care to avoid these damages.

1. The products and the product specifications described in this document are subject to change or discontinuation of production without notice for reasons such as improvement. Therefore, before deciding to use the products, please refer to our sales representatives for the latest information thereon.
2. The materials in this document may not be copied or otherwise reproduced in whole or in part without the prior written consent of us.
3. This product and any technical information relating thereto are subject to complementary export controls (so-called KNOW controls) under the Foreign Exchange and Foreign Trade Law, and related politics ministerial ordinance of the law. (Note that the complementary export controls are inapplicable to any application-specific products, except rockets and pilotless aircraft, that are insusceptible to design or program changes.) Accordingly, when exporting or carrying abroad this product, follow the Foreign Exchange and Foreign Trade Control Law and its related regulations with respect to the complementary export controls.
4. The technical information described in this document shows typical characteristics and example application circuits for the products. The release of such information is not to be construed as a warranty of or a grant of license under our or any third party's intellectual property rights or any other rights.
5. The products listed in this document are intended and designed for use as general electronic components in standard applications (office equipment, telecommunication equipment, measuring instruments, consumer electronic products, amusement equipment etc.). Those customers intending to use a product in an application requiring extreme quality and reliability, for example, in a highly specific application where the failure or misoperation of the product could result in human injury or death should first contact us.
 - Aerospace Equipment
 - Equipment Used in the Deep Sea
 - Power Generator Control Equipment (nuclear, steam, hydraulic, etc.)
 - Life Maintenance Medical Equipment
 - Fire Alarms / Intruder Detectors
 - Vehicle Control Equipment (automotive, airplane, railroad, ship, etc.)
 - Various Safety Devices
 - Traffic control system
 - Combustion equipment

In case your company desires to use this product for any applications other than general electronic equipment mentioned above, make sure to contact our company in advance. Note that the important requirements mentioned in this section are not applicable to cases where operation requirements such as application conditions are confirmed by our company in writing after consultation with your company.

6. We are making our continuous effort to improve the quality and reliability of our products, but semiconductor products are likely to fail with certain probability. In order to prevent any injury to persons or damages to property resulting from such failure, customers should be careful enough to incorporate safety measures in their design, such as redundancy feature, fire containment feature and fail-safe feature. We do not assume any liability or responsibility for any loss or damage arising from misuse or inappropriate use of the products.
7. The products have been designed and tested to function within controlled environmental conditions. Do not use products under conditions that deviate from methods or applications specified in this datasheet. Failure to employ the products in the proper applications can lead to deterioration, destruction or failure of the products. We shall not be responsible for any bodily injury, fires or accident, property damage or any consequential damages resulting from misuse or misapplication of the products.
8. **Quality Warranty**
 - 8-1. **Quality Warranty Period**

In the case of a product purchased through an authorized distributor or directly from us, the warranty period for this product shall be one (1) year after delivery to your company. For defective products that occurred during this period, we will take the quality warranty measures described in section 8-2. However, if there is an agreement on the warranty period in the basic transaction agreement, quality assurance agreement, delivery specifications, etc., it shall be followed.
 - 8-2. **Quality Warranty Remedies**

When it has been proved defective due to manufacturing factors as a result of defect analysis by us, we will either deliver a substitute for the defective product or refund the purchase price of the defective product.
Note that such delivery or refund is sole and exclusive remedies to your company for the defective product.
 - 8-3. **Remedies after Quality Warranty Period**

With respect to any defect of this product found after the quality warranty period, the defect will be analyzed by us. On the basis of the defect analysis results, the scope and amounts of damage shall be determined by mutual agreement of both parties. Then we will deal with upper limit in Section 8-2. This provision is not intended to limit any legal rights of your company.
9. Anti-radiation design is not implemented in the products described in this document.
10. The X-ray exposure can influence functions and characteristics of the products. Confirm the product functions and characteristics in the evaluation stage.
11. WLCSP products should be used in light shielded environments. The light exposure can influence functions and characteristics of the products under operation or storage.
12. Warning for handling Gallium and Arsenic (GaAs) products (Applying to GaAs MMIC, Photo Reflector). These products use Gallium (Ga) and Arsenic (As) which are specified as poisonous chemicals by law. For the prevention of a hazard, do not burn, destroy, or process chemically to make them as gas or power. When the product is disposed of, please follow the related regulation and do not mix this with general industrial waste or household waste.
13. Please contact our sales representatives should you have any questions or comments concerning the products or the technical information.



Nisshinbo Micro Devices Inc.

Official website

<https://www.nisshinbo-microdevices.co.jp/en/>

Purchase information

<https://www.nisshinbo-microdevices.co.jp/en/buy/>