



EBRT60L100FCT



Excellent Schottky Barrier Rectifiers



ITO-220AB

Primary Characteristics

I_F	60	A
V_{RRM}	100	V
I_{FSM}	250	A
V_F	0.8	V
T_J max	150	°C

Features

- Low Forward Voltage Drop
- Excellent High Temperature Stability
- Excellent Barrier Rectifier Technology
- Soft, Fast Switching Capability

Mechanical Data

- Case: ITO-220AB
- Case Material: Molded Plastic, UL Flammability Classification Rating 94V-0
- Terminals: Matte Tin Finish annealed over Copper leadframe. Solderable per MIL-STD-202, Method 208
- Weight: 1.645 grams (approximate)

Ordering Information

Part No.	Remark	Package	Packing
EBRT60L100FCT	General	ITO-220AB	50 & 2000 / Tube & Box
EBRT60L100FCT-H	Halogen Free		

Maximum Ratings (TA=25°C unless otherwise noted)

PARAMETER	SYMBOL	EBRT60L100FCT	UNIT
Maximum repetitive peak reverse voltage	V_{RRM}	100	V
Maximum RMS voltage	V_{RMS}	70	V
Maximum DC blocking voltage	V_{DC}	100	V
Maximum average forward rectified current (Total) (Per Leg)	I_F	60 30	A
Peak forward surge current, 8.3ms single half sine-wave superimposed on rated load	I_{FSM}	250	A
Maximum Instantaneous Forward Voltage $I_F=30A @ 25^\circ C$	V_F	0.8	V
Maximum DC Reverse Current @ TA=25°C at Rated DC Blocking Voltage @ TA=125°C	I_R	0.2 50	mA
Typical Junction Capacitance(NOTE1)	C_j	2000	pF
Typical Thermal Resistance	$R_{\theta JC}$	3	°C/W
Operating Temperature Range	T_J	-55 to +150	°C
Storage Temperature Range	T_{STG}	-55 to +150	°C
Marking Code		T60L100FCT、60L100FCT	

NOTES:

1. Measured at 1.0MHz and applied reverse voltage of 4.0V DC



Excellent Schottky Barrier Rectifiers

Rating and Characteristics Curves

FIG. 1-Typical Forward Current Derating Curve

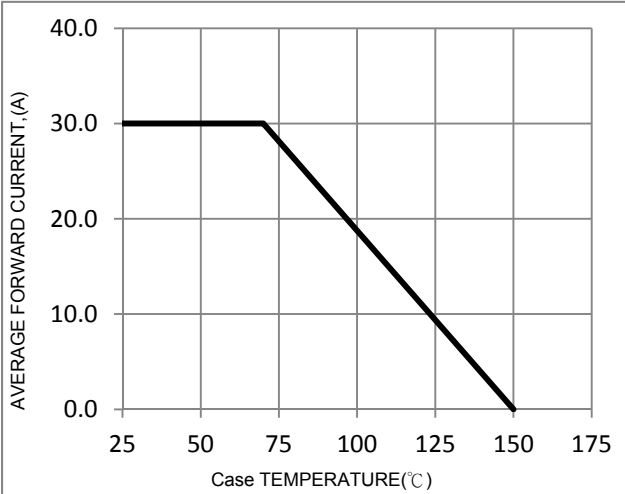

FIG. 2-Typical Forward Characteristics

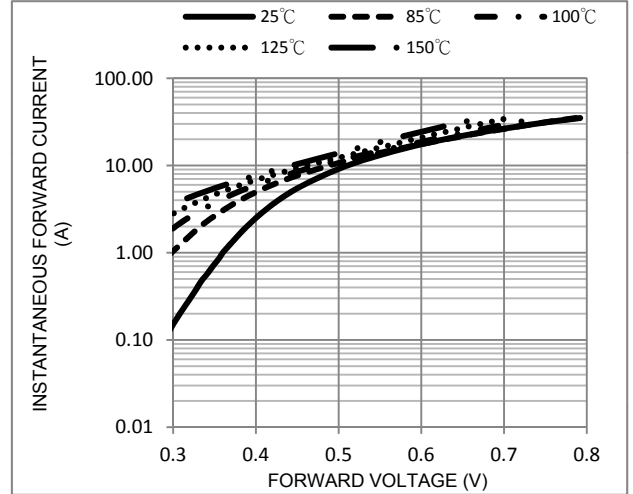

FIG. 3-Maximum Non-Repetitive Forward Surge Current

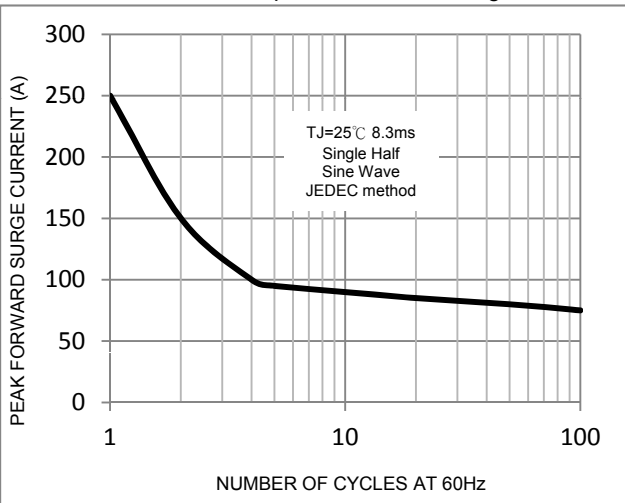

FIG. 4-Typical Reverse Characteristics

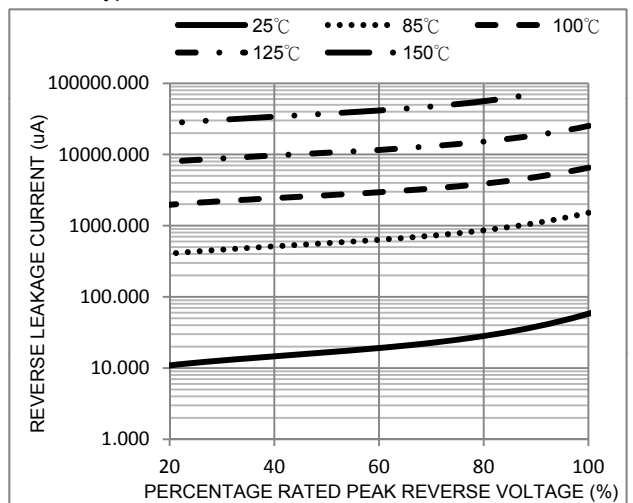
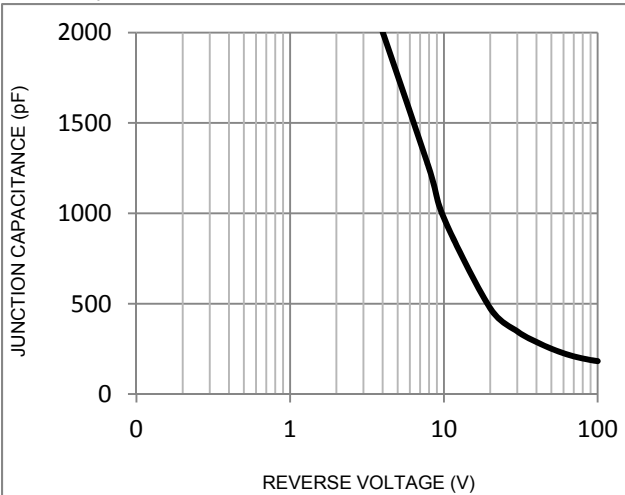
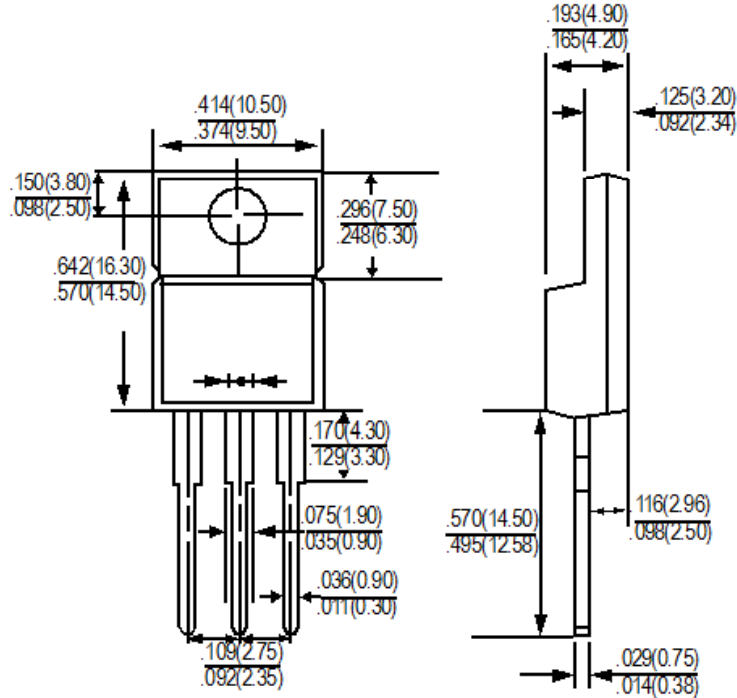

FIG. 5-Typical Junction Capacitance





Package Outline Dimensions



ITO-220AB

Dimensions in inches and (millimeters)

Marking Information

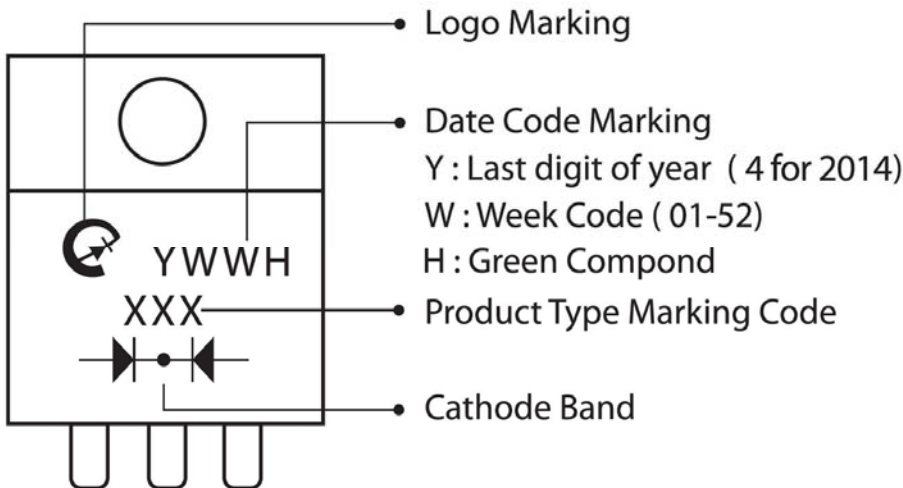



LEGAL DISCLAIMER

- The product is provided “AS IS” without any guarantees or warranty. In association with the product, Eris Technology Corporation, its affiliates, and their directors, officers, employees, agents, successors and assigns (collectively, the “Eris”) makes no warranties of any kind, either express or implied, including but not limited to warranties of merchantability, fitness for a particular purpose, of title, or of non-infringement of third party rights.
- The information in this document and any product described herein are subject to change without notice and should not be construed as a commitment by Eris. Eris assumes no responsibility for any errors that may appear in this document.
- Eris does not assume any liability arising out of the application or use of this document or any product described herein, any Customer or user of this document or products described herein in such applications shall assume all risks of such use and will agree to hold Eris and all the companies whose products are represented on Eris website, harmless against all damages.
- No license, express or implied, by estoppels or otherwise, to any intellectual property is granted by this document or by any conduct of Eris. Product name and markings notes herein may be trademarks of their respective owners.
- Eris does not warrant or accept any liability whatsoever in respect of any products purchased through unauthorized sales channel.
- Should Customers purchase or use Eris products for any unintended or unauthorized application, Customers shall indemnify and hold Eris and its representatives harmless against all claims, damages, expenses, and attorney fees arising out of, directly or indirectly, any claim of personal injury or death associated with such unintended or unauthorized application.
- The official text is written in English and the English version of this document is the only version endorsed by Eris. Any discrepancies or differences created in the translations are not binding and have no legal effect on Eris for compliance or enforcement purposes.