

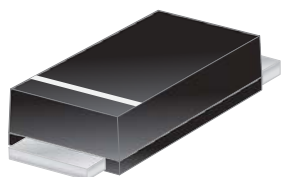

## Excellen Schottky Barrier Rectifiers



**DO-221AC(SMAF)**

### Primary Characteristics

$I_F$	3	A
$V_{RRM}$	100	V
$I_{FSM}$	80	A
$V_F$	0.6	V
$T_J \text{ max}$	150	°C

### Features

- High current capability
- High surge current capability
- Low reverse current

### Mechanical Data

- Case: DO-221AC(SMAF)
- Case Material: Molded Plastic. UL Flammability Classification Rating 94V-0
- Terminals: Lead Free Plating (Tin Finish). Solderable per MIL-STD-202, Method 208
- Polarity: Cathode Band
- Weight: 0.035 grams (approximate)

### Ordering Information

Part No.	Remark	Package	Packing
EBRT3E100AF	General	SMAF	10000 / Tape & Reel
EBRT3E100AF-H	Halogen Free		
EBRT3E100AF-Q	AEC-Q101 qualified		

### Maximum Ratings (TA=25°C unless otherwise noted)

PARAMETER	SYMBOL	EBRT3E100AF	UNIT
Maximum repetitive peak reverse voltage	$V_{RRM}$	100	V
Maximum RMS voltage	$V_{RMS}$	70	V
Maximum DC blocking voltage	$V_{DC}$	100	V
Maximum average forward rectified current	$I_F$	3	A
Peak forward surge current, 8.3ms single half sine-wave superimposed on rated load	$I_{FSM}$	80	A
Maximum Instantaneous Forward Voltage $I_F=3A @ 25^\circ C$	$V_F$	0.54 Typ. 0.60 Max.	V
Maximum DC Reverse Current @ TA=25°C at Rated DC Blocking Voltage @ TA=100°C	$I_R$	0.5 10	mA
Typical Junction Capacitance(NOTE1)	$C_j$	400	pF
Typical Thermal Resistance	$R_{\theta JC}$	35	°C/W
Operating Temperature Range	$T_J$	-55 to +150	°C
Storage Temperature Range	$T_{STG}$	-55 to +150	°C
Marking Code		T3E100AF、3E100AF	

### NOTES:

1.Measured at 1.0MHz and applied reverse voltage of 4.0V DC



## Excellent Schottky Barrier Rectifiers

### Rating and Characteristics Curves

FIG. 1-Typical Forward Current Derating Curve

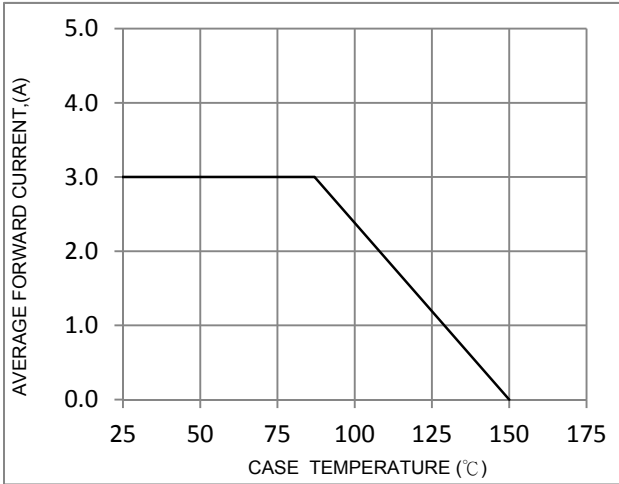

FIG. 2-Typical Forward Characteristics

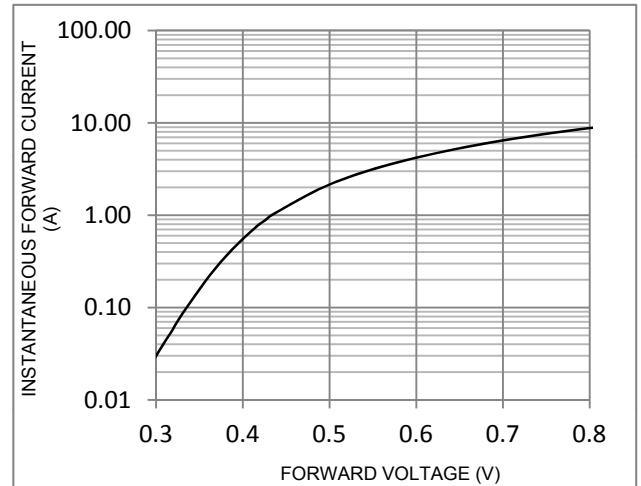

FIG. 3-Maximum Non-Repetitive Forward Surge Current

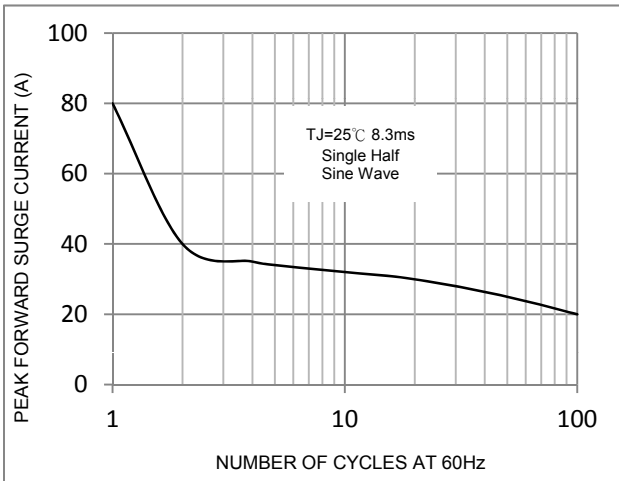

FIG. 4-Typical Reverse Characteristics

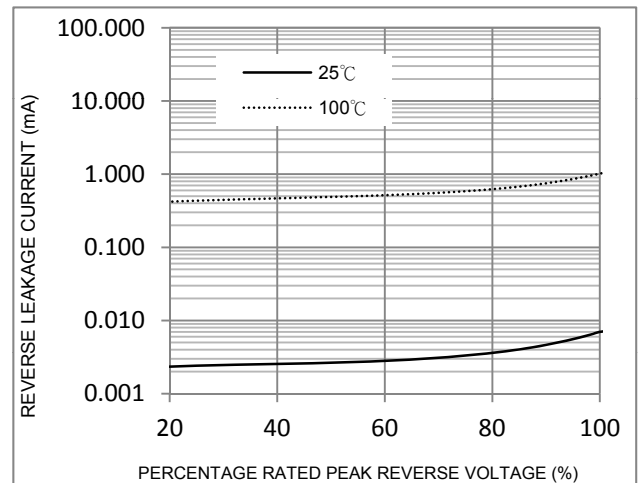
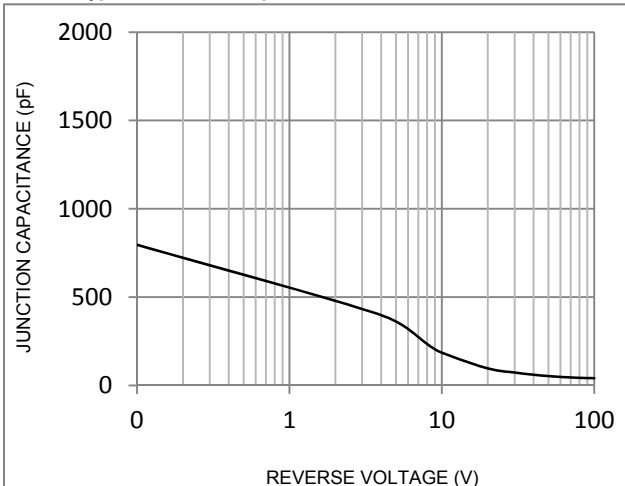
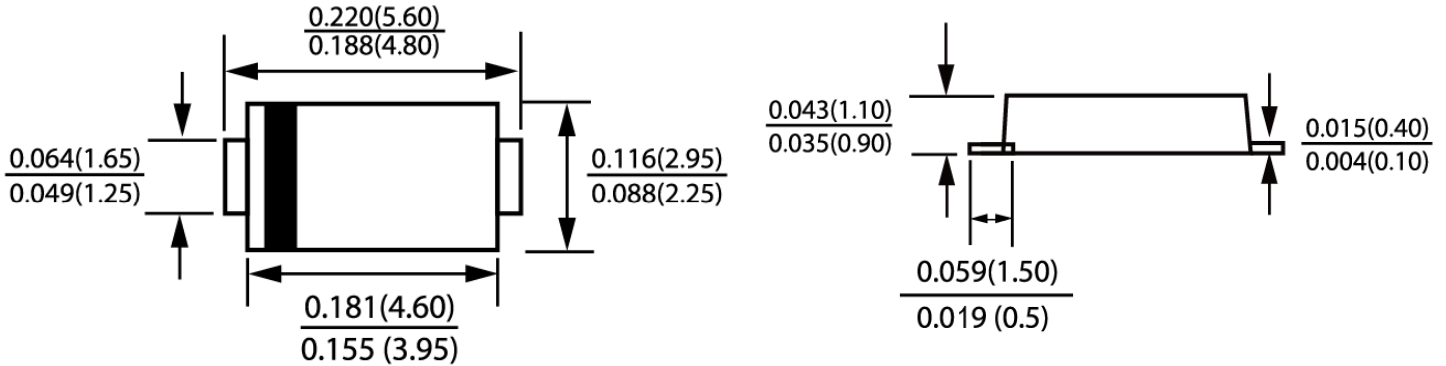

FIG. 5-Typical Junction Capacitance





**Package Outline Dimensions**



**DO-221AC(SMAF)**

Dimensions in inches and (millimeters)

**Marking Information**

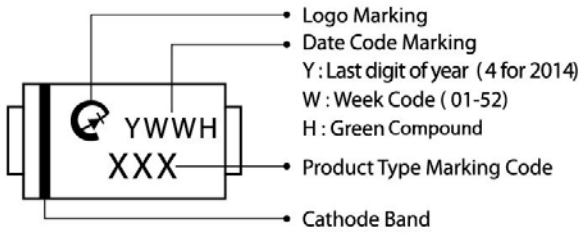

**Suggested Pad Layout**

Dimension	Outline	SMAF (DO-221AC)
A		6.50
B		1.50
C		1.70
D		2.50
E		4.00

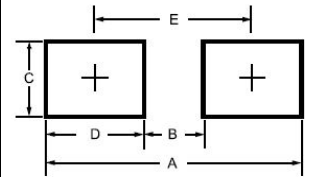

**Tape & Reel Specification**

ITEM	SYMBOL	SMAF(mm) DO-221AC
Carrier width	A	3±0.1
Carrier length	B	5.6±0.1
Carrier depth	C	1.2±0.1
Sprocket hole	d	1.50±0.1
Reel outside diameter	D	330±2.0
Feed hole diameter	D0	13.5±1
Reel inner diameter	D1	50 (min.)
Sprocket hole position	E	1.75±0.1
Punch hole position	F	5.5±0.05
Sprocket hole pitch	P	4.0±0.1
Sprocket hole pitch	P0	4.0±0.05
Embossment center	P1	2.0±0.05
Overall tape thickness	T	0.25±0.05
Tape width	W	12.0±0.2
Reel width	W2	18.4 (max)
Reel width	W1	14.4 (max)

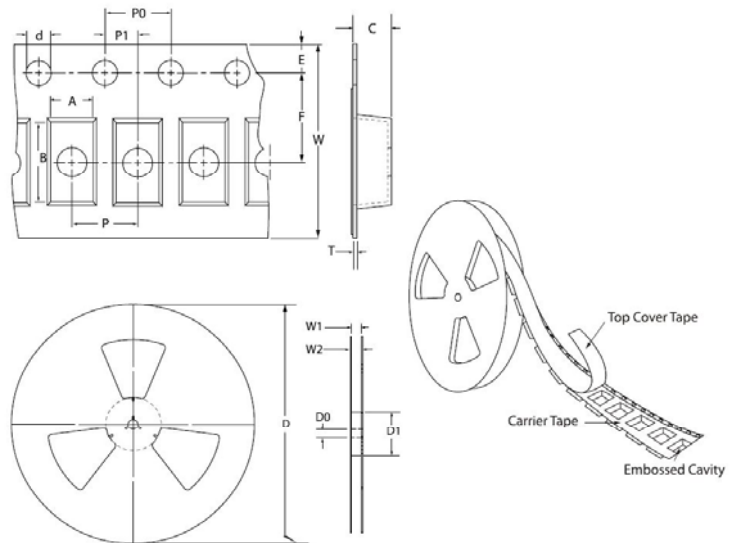



## **LEGAL DISCLAIMER**

- The product is provided “AS IS” without any guarantees or warranty. In association with the product, Eris Technology Corporation, its affiliates, and their directors, officers, employees, agents, successors and assigns (collectively, the “Eris”) makes no warranties of any kind, either express or implied, including but not limited to warranties of merchantability, fitness for a particular purpose, of title, or of non-infringement of third party rights.
- The information in this document and any product described herein are subject to change without notice and should not be construed as a commitment by Eris. Eris assumes no responsibility for any errors that may appear in this document.
- Eris does not assume any liability arising out of the application or use of this document or any product described herein, any Customer or user of this document or products described herein in such applications shall assume all risks of such use and will agree to hold Eris and all the companies whose products are represented on Eris website, harmless against all damages.
- No license, express or implied, by estoppels or otherwise, to any intellectual property is granted by this document or by any conduct of Eris. Product name and markings notes herein may be trademarks of their respective owners.
- Eris does not warrant or accept any liability whatsoever in respect of any products purchased through unauthorized sales channel.
- Should Customers purchase or use Eris products for any unintended or unauthorized application, Customers shall indemnify and hold Eris and its representatives harmless against all claims, damages, expenses, and attorney fees arising out of, directly or indirectly, any claim of personal injury or death associated with such unintended or unauthorized application.
- The official text is written in English and the English version of this document is the only version endorsed by Eris. Any discrepancies or differences created in the translations are not binding and have no legal effect on Eris for compliance or enforcement purposes.